

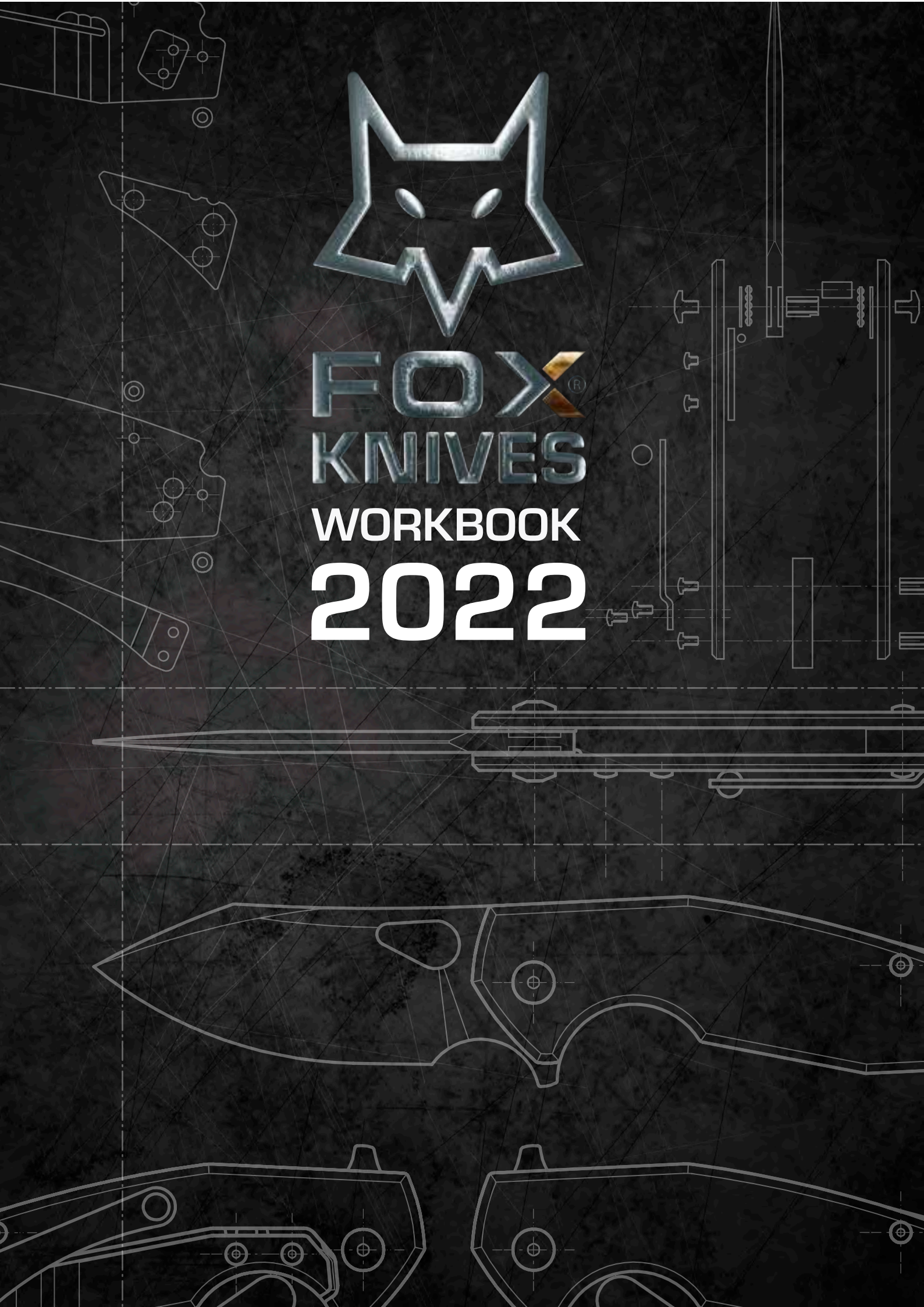

FOX[®]
KNIVES
WORKBOOK
2022





INDICE

INDEX

| | |
|--|-----------------|
| LA NOSTRA STORIA - OUR HISTORY | PAG. 2 |
| I PREMI - THE AWARDS | PAG. 4 |
| COLTELLI CHIUDIBILI FOX - FOX FOLDING KNIVES | PAG. 6 |
| COLTELLI LAMA FISSA FOX - FOX FIXED BLADE KNIVES | PAG. 56 |
| TAGLIASIGARI FOX - FOX CIGAR CUTTERS | PAG. 76 |
| COLTELLI CHIUDIBILI FKMD - FKMD FOLDING KNIVES | PAG. 86 |
| COLTELLI LAMA FISSA FKMD - FKMD FIXED BLADE KNIVES | PAG. 96 |
| COLTELLI CHIUDIBILI BLACKFOX - BLACKFOX FOLDING KNIVES | PAG. 116 |
| COLTELLI LAMA FISSA BLACKFOX - BLACKFOX FIXED BLADE KNIVES | PAG. 132 |
| ATTREZZI MULTIUSO E BUSSOLE BLACKFOX BLACKFOX MULTITOOLS AND COMPASSES | PAG. 140 |
| ATTREZZI MULTIUSO E ACCESSORI MULTITOOLS AND ACCESSORIES | PAG. 145 |
| INDICE DEI CODICI - CODES INDEX | PAG. 165 |
| LEGENDA - LEGEND | PAG. 167 |
| FINITURE - FINISHES | PAG. 168 |
| TABELLA DEGLI ACCIAI - STEEL CHART | PAG. 169 |

FOX[®] KNIVES

SEDE CENTRALE
HEAD QUARTER



SEDE PRODUTTIVA
MANUFACTURING SITE



L'MK Ultra Kukri vince il premio
"Collaboration of the Year" al Blade Show.
MK Ultra Kukri wins the "Collaboration of
the Year" award at Blade Show.

L'FX-521 DRB Desert Fox vince il premio
"Most Innovative Imported Design" al Blade Show.
FX-521 DRB Desert Fox wins the
"Most Innovative Imported Design" award at Blade Show.

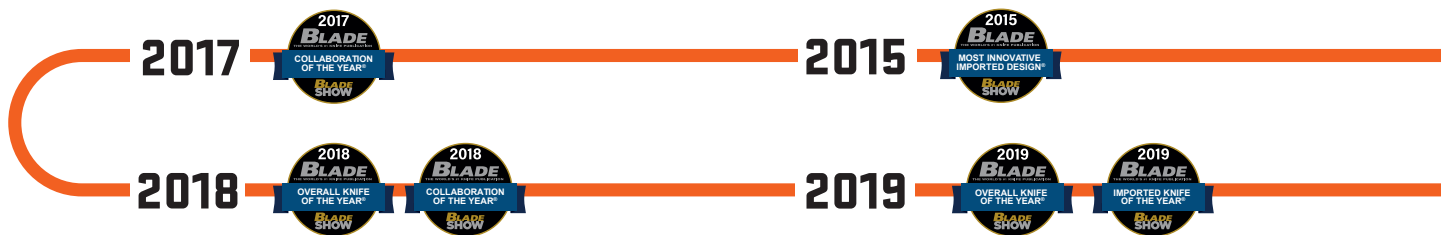

Il Fox Suru vince il premio "Overall Knife of the Year" e l'MKM Arvenis vince il premio "Collaboration of the Year" al Blade Show.
Fox Suru wins the "Overall Knife of the Year" award and MKM Arvenis wins the "Collaboration of the Year" award at Blade Show.

Il Fox Radius vince il premio "Imported Knife of the Year" e "Overall Knife of the Year" al Blade Show.
Fox Radius wins the "Imported Knife of the Year" and "Overall Knife of the Year" award at Blade Show.



NATO N/CAGE CODE=AG180

LA NOSTRA STORIA OUR HISTORY

Oreste Frati era un esperto nella produzione e nel commercio di coltelli e, dopo che nel 1977 fondò le Coltellerie Fox, vide questa nuova realtà crescere spinta dalla fame di innovazione tecnica e dalla centenaria tradizione professionale che caratterizza Maniago.

Oreste Frati was an expert in knife production and trade and, after he founded Fox Cutlery in 1977, he saw this new reality grow driven by the hunger for technical innovation and the centenary professional tradition that characterizes Maniago.

1977

Oreste Frati fonda le Coltellerie Fox.
Oreste Frati establishes Fox Cutlery.

1990

Acquisizione della ditta RCE ed inizio della produzione nella nuova sede.
Acquisition of RCE company and beginning of production in the new location.

2008

Fondazione di Euroknives: produzione di Fox.
Founding of Euroknives: Fox production.

2009

Il REZ 02 vince il premio "Most Innovative American Design" al Blade Show.
REZ 02 wins the "Most Innovative American Design" award at Blade Show.



2011

L'FX-301 Dobilock vince il premio "Most Innovative Imported Design" al Blade Show.
FX-301 Dobilock wins the "Most Innovative Imported Design" award at Blade Show.



L'FX-508 Modras vince il premio "Imported Knife of the Year" al Blade Show.
FX-508 Modras wins the "Imported Knife of the Year" award at Blade Show.

2013



2020



Il Fox Radius vince il premio Red Dot Design Award 2020 per il miglior prodotto.
Fox Radius wins the Red Dot Design Award 2020 as best product.

2021



Il Fox Saturn vince il premio "Imported Knife of the Year" e "Overall Knife of the Year" al Blade Show.
Fox Saturn wins the "Imported Knife of the Year" and "Overall Knife of the Year" award at Blade Show.

I PREMI THE AWARDS



REZ Q2



2003 • Coltelli all'EXA 1°edizione
Miglior lama Fissa
468 Tecnoreef



FX-301 Dobolock



FX-508 Modras



FX-521 DRB Desert Fox



2010 • IWA International knife Award
Special Knives
FX-SOK09CM01E Col Moschin



MK Ultra KUKRI



MKM ARVENIS



2012 • GRAY'S BEST
Elite Range Pocket Knives
271 OL





COMING SOON!





COLTELLI CHIUDIBILI FOX **FOX FOLDING KNIVES**

Questa categoria è forse la più variegata dell'intera gamma, comprende un'ampia scelta di meccanismi di apertura, forme delle lame, acciai e finiture. Ciò che non varia affatto è la cura per il dettaglio e l'alta qualità dei materiali lavorati in Italia.

This category is perhaps the most varied of the entire range, including a wide choice of opening mechanisms, blade shapes, steels and finishes. What does not vary at all is the attention to detail and the high quality of the materials machined in Italy.







EASTWOOD TIGER by Gudy Van Poppel - FRAME LOCK

FX-524 TiCF









-  CPM S90V
-  HRC 59-61
-  Coarse stone washed
-  4 mm - 0.16"
-  190 g - 6.70 oz
-  Titanio sabbaiato con inserto in fibra di carbonio
Bead blasted Titanium with Carbon Fiber insert

-  **Titanio sabbaiato**
Bead blasted Titanium
-  **Titanio anodizzato bronzo**
Bronze anodized Titanium
-  **Titanio anodizzato bronzo**
Bronze anodized Titanium
-  **Titanio anodizzato bronzo**
Bronze anodized Titanium
-  **Movimento con cuscinetti a sfere**
Ball Bearing operating system
-  **Cuoio**
Leather

EASTWOOD TIGER by Gudy Van Poppel - FRAME LOCK

FX-524 TI



-  CPM S90V
-  HRC 59-61
-  PVD (Physical Vapor Deposition)
-  4 mm - 0.16"
-  200 g - 7.05 oz
-  Titanio PVD
PVD Titanium

-  **Titanio PVD**
PVD Titanium
-  **Titanio anodizzato blu**
Blue anodized Titanium
-  **Titanio anodizzato blu**
Blue anodized Titanium
-  **Titanio anodizzato blu**
Blue anodized Titanium
-  **Movimento con cuscinetti a sfere**
Ball Bearing operating system
-  **Cuoio**
Leather

EASTWOOD TIGER by Gudy Van Poppel - FRAME LOCK

FX-524 TiZW









-  CPM S90V
-  HRC 59-61
-  Satinata
Satin
-  4 mm - 0.16"
-  185 g - 6.52 oz
-  Titanio anodizzato bronzo con inserto in legno di Ziricote
Bronze anodized Titanium with Ziricote wood insert

-  **Titanio anodizzato bronzo**
Bronze anodized Titanium
-  **Titanio sabbaiato**
Bead blasted Titanium
-  **Titanio sabbaiato**
Bead blasted Titanium
-  **Titanio lucido**
Polished Titanium
-  **Movimento con cuscinetti a sfere**
Ball Bearing operating system
-  **Cuoio**
Leather

EASTWOOD TIGER by Gudy Van Poppel - LINER LOCK

FX-524 B



-  D2
-  HRC 59-61
-  Black idrogliker stone washed
-  4 mm - 0.16"
-  175 g - 6.17 oz
-  G10 nero lavorato in 3D
3D machined black G10





-  **Acciaio inox AISI 420 Black idrogliker**
Black idrogliker AISI 420 Stainless Steel
-  **Acciaio inox AISI 420 black idrogliker**
Black idrogliker 420 Stainless Steel
-  **Alluminio anodizzato grigio**
Gray anodized Aluminium
-  **Acciaio inox AISI 303 black idrogliker**
Black idrogliker AISI 303 Stainless Steel
-  **Movimento con cuscinetti a sfere**
Ball Bearing operating system
-  **Cuoio, Feltro e Nylon®**
Leather, Felt and Nylon®

EASTWOOD TIGER by Gudy Van Poppel - LINER LOCK

FX-524 G



-  D2
-  HRC 59-61
-  Stone washed
-  4 mm - 0.16"
-  165 g - 5.82 oz
-  Micarta verde OD lavorata in 3D
3D machined OD green Micarta

-  **Acciaio inox AISI 420 lucido**
Polished AISI 420 Stainless Steel
-  **Acciaio inox AISI 420 stone washed**
Stone washed 420 Stainless Steel
-  **Alluminio anodizzato bronzo**
Bronze anodized Aluminium
-  **Acciaio inox AISI 303 lucido**
Polished AISI 303 Stainless Steel
-  **Movimento con cuscinetti a sfere**
Ball Bearing operating system
-  **Cuoio, Feltro e Nylon®**
Leather, Felt and Nylon®

NEW!

SURU by Jesper Voxnæs - FRAME LOCK - LIMITED EDITION

FX-526LE BR



- CPM 20CV
- HRC 59-61
- Satinata
Satin
- 4 mm - 0.16"
- 95 g - 3.35 oz
- Titanio anodizzato bronzo
Bronze anodized Titanium

- Titanio anodizzato bronzo
Bronze anodized Titanium
- Titanio anodizzato bronzo
Bronze anodized Titanium
- Titanio anodizzato bronzo
Bronze anodized Titanium
- Titanio anodizzato bronzo
Bronze anodized Titanium
- Movimento con cuscinetti a sfere
Ball Bearing operating system
- Cuoio
Leather

NEW!

SURU by Jesper Voxnæs - FRAME LOCK - LIMITED EDITION

FX-526LE CF



- CPM 20CV
- HRC 59-61
- PVD stone washed
- 4 mm - 0.16"
- 80 g - 2.81 oz
- Arctic Storm Carbon Fiber
by Fat Carbon Materials®

- Titanio PVD stone washed
PVD stone washed Titanium
- Titanio PVD stone washed
PVD stone washed Titanium
- Fibra di carbonio
Carbon fiber
- Titanio PVD
PVD Titanium
- Movimento con cuscinetti a sfere
Ball Bearing operating system
- Cuoio
Leather

NEW!

SURU by Jesper Voxnæs - FRAME LOCK - LIMITED EDITION

FX-526LE COP



- CPM 20CV
- HRC 59-61
- Coarse stone washed
- 4 mm - 0.16"
- 120 g - 4.23 oz
- Rame inciso al laser
Laser engraved copper

- Titanio coarse stone washed
Coarse stone washed Titanium
- Titanio coarse stone washed
Coarse stone washed Titanium
- Rame
Copper
- Titanio coarse stone washed
Coarse stone washed Titanium
- Movimento con cuscinetti a sfere
Ball Bearing operating system
- Cuoio
Leather

SURU by Jesper Voxnæs - FRAME LOCK

FX-526 CF



- M390
- HRC 59-61
- Satinata
Satin
- 4 mm - 0.16"
- 58 g - 2.04 oz
- Fibra di carbonio
Carbon fiber

- Fibra di carbonio
Carbon fiber
- Titanio anodizzato bronzo
Bronze anodized Titanium
- Fibra di carbonio
Carbon fiber
- Titanio anodizzato bronzo
Bronze anodized Titanium
- Movimento con cuscinetti a sfere
Ball Bearing operating system

SURU by Jesper Voxnæs - FRAME LOCK

FX-526 CFBL



- M390
- HRC 59-61
- Satinata
Satin
- 4 mm - 0.16"
- 58 g - 2.04 oz
- Fibra di carbonio
Carbon fiber

- Fibra di carbonio
Carbon fiber
- Titanio anodizzato blu
Blue anodized Titanium
- Fibra di carbonio
Carbon fiber
- Titanio anodizzato blu
Blue anodized Titanium
- Movimento con cuscinetti a sfere
Ball Bearing operating system

SURU by Jesper Voxnæs - FRAME LOCK

FX-526 TCB



- M390
- HRC 59-61
- Satinata
Satin
- 4 mm - 0.16"
- 72 g - 2.53 oz
- Fibra di carbonio
Carbon fiber

- Titanio sabbiato
Bead blasted Titanium
- Titanio anodizzato bronzo
Bronze anodized Titanium
- Fibra di carbonio
Carbon fiber
- Titanio anodizzato bronzo
Bronze anodized Titanium
- Movimento con cuscinetti a sfere
Ball Bearing operating system
- Cuoio
Leather

SURU by Jesper Voxnæs - FRAME LOCK

FX-526 TCBL



- M390
- HRC 59-61
- Satinata
Satin
- 4 mm - 0.16"
- 72 g - 2.53 oz
- Fibra di carbonio
Carbon fiber

- Titanio sabbiato
Bead blasted Titanium
- Titanio anodizzato blu
Blue anodized Titanium
- Fibra di carbonio
Carbon fiber
- Titanio anodizzato blu
Blue anodized Titanium
- Movimento con cuscinetti a sfere
Ball Bearing operating system
- Cuoio
Leather

SURU by Jesper Voxnæs - FRAME LOCK

FX-526 ALB



- N690Co
- HRC 58-60
- Black idroglider stone washed
- 4 mm - 0.16"
- 85 g - 2.99 oz
- Alluminio aeronautico 7075
anodizzato nero stone washed
Black anodized stone washed 7075
Aircraft Aluminium

- Alluminio aeronautico 7075 anodizzato nero
stone washed - Black anodized stone washed
7075 Aircraft Aluminium
- Acciaio inox AISI 302 black idroglider
Black idroglider AISI 302 Stainless Steel
- Alluminio aeronautico 7075 anodizzato nero
stone washed - Black anodized stone washed
7075 Aircraft Aluminium
- Acciaio inox AISI 303 black idroglider
Black idroglider AISI 303 Stainless Steel
- Movimento con cuscinetti a sfere
Ball Bearing operating system

SURU by Jesper Voxnæs - FRAME LOCK

FX-526 ALG



- N690Co
- HRC 58-60
- Black idroglider stone washed
- 4 mm - 0.16"
- 85 g - 2.99 oz
- Alluminio aeronautico 7075
anodizzato verde stone washed
Green anodized stone washed 7075
Aircraft Aluminium

- Alluminio aeronautico 7075 anodizzato verde
stone washed - Green anodized stone washed
7075 Aircraft Aluminium
- Acciaio inox AISI 302 black idroglider
Black idroglider AISI 302 Stainless Steel
- Alluminio aeronautico 7075 anodizzato nero
stone washed - Black anodized stone washed
7075 Aircraft Aluminium
- Acciaio inox AISI 303 black idroglider
Black idroglider AISI 303 Stainless Steel
- Movimento con cuscinetti a sfere
Ball Bearing operating system

SURU by Jesper Voxnæs - FRAME LOCK

FX-526 ALO



- N690Co
- HRC 58-60
- Black idroglider stone washed
- 4 mm - 0.16"
- 85 g - 2.99 oz
- Alluminio aeronautico 7075
anodizzato arancione stone washed
Orange anodized stone washed 7075
Aircraft Aluminium







- Alluminio aeronautico 7075 anodizzato arancione
stone washed - Orange anodized stone
washed 7075 Aircraft Aluminium
- Acciaio inox AISI 302 black idroglider
Black idroglider AISI 302 Stainless Steel
- Alluminio aeronautico 7075 anodizzato nero
stone washed - Black anodized stone washed
7075 Aircraft Aluminium
- Acciaio inox AISI 303 black idroglider
Black idroglider AISI 303 Stainless Steel
- Movimento con cuscinetti a sfere
Ball Bearing operating system







NEW!

YARU by Jesper Voxnæs - FRAME LOCK

FX-527 TIPVD



-  CPM S90V
-  HRC 59-61
-  PVD stone washed
-  4 mm - 0.16"
-  105 g - 3.70 oz
-  Titanio PVD stone washed
PVD stone washed Titanium

-  Titanio PVD stone washed
PVD stone washed Titanium
-  Titanio anodizzato bronzo
Bronze anodized Titanium
-  Titanio PVD stone washed
PVD stone washed Titanium
-  Titanio anodizzato bronzo
Bronze anodized titanium
-  Movimento con cuscinetti a sfere
Ball Bearing operating system
-  Cuoio
Leather







NEW!

YARU by Jesper Voxnæs - FRAME LOCK

FX-527 TI



-  CPM S90V
-  HRC 59-61
-  Coarse stone wash
-  4 mm - 0.16"
-  105 g - 3.70 oz
-  Titanio anodizzato blu stone washed
Blue anodized stone washed Titanium



-  Titanio anodizzato blu stone washed
Blue anodized stone washed Titanium
-  Titanio anodizzato blu
Blue anodized Titanium
-  Titanio coarse stone washed
Coarse stone washed Titanium
-  Titanio anodizzato blu
Blue anodized Titanium
-  Movimento con cuscinetti a sfere
Ball Bearing operating system
-  Cuoio
Leather







NEW!

YARU by Jesper Voxnæs - FRAME LOCK

FX-527 CF



-  CPM S90V
-  HRC 59-61
-  PVD stone washed
-  4 mm - 0.16"
-  95 g - 3.35 oz
-  Space Coral by Fat Carbon Materials®
(Composto di Fibra di Carbonio e Rame)
Space Coral by Fat Carbon Materials®
(Carbon Fiber and Copper composite)







-  Titanio PVD stone washed
PVD stone washed Titanium
-  Titanio PVD stone washed
PVD stone washed Titanium
-  Titanio PVD stone washed
PVD stone washed Titanium
-  Titanio PVD stone washed
PVD stone washed Titanium
-  Movimento con cuscinetti a sfere
Ball Bearing operating system
-  Cuoio
Leather





NEW!

BABY CORE by Jesper Voxnæs - LINER LOCK

FX-608 TI



-  M390
-  HRC 59-61
-  Coarse stone washed
-  3 mm - 0.11"
-  110 g - 3.88 oz
-  Titanio coarse stone washed
sagomato - Contoured coarse
stone washed Titanium







-  Acciaio inox AISI 420 sabbato
Bead blasted AISI 420 Stainless Steel
-  Acciaio inox AISI 302 sabbato
Bead blasted AISI 302 Stainless Steel
-  Titanio anodizzato bronzo
Bronze anodized titanium
-  Acciaio inox AISI 303 sabbato
Bead blasted AISI 303 Stainless Steel
-  Movimento con cuscinetti a sfere
Ball Bearing operating system
-  Cuoio
Leather

NEW!

BABY CORE by Jesper Voxnæs - LINER LOCK

FX-608 CF



-  M390
-  HRC 59-61
-  Satinata
Satin
-  3 mm - 0.11"
-  80 g - 2.82 oz
-  Fibra di carbonio sagomata
Contoured Carbon fiber

-  Acciaio inox AISI 420 lucido
Polished AISI 420 Stainless Steel
-  Acciaio inox AISI 302 sabbato
Bead blasted AISI 302 Stainless Steel
-  Fibra di carbonio
Carbon fiber
-  Acciaio inox AISI 303 lucido
Polished AISI 303 Stainless Steel
-  Movimento con cuscinetti a sfere
Ball Bearing operating system
-  Cuoio
Leather

NEW!

BABY CORE by Jesper Voxnæs - LINER LOCK

FX-608 MC



- M390**
- HRC 59-61**
- Coarse stone washed**
- 3 mm - 0.11"**
- 80 g - 2.82 oz**
- Micarta naturale sagomata**
Contoured Natural Canvas Micarta

- Acciaio inox AISI 420 sabbato**
Bead blasted AISI 420 Stainless Steel
- Acciaio inox AISI 302 sabbato**
Bead blasted AISI 302 Stainless Steel
- Ottone**
Brass
- Acciaio inox AISI 303 sabbato**
Bead blasted AISI 303 Stainless Steel
- Movimento con cuscinetti a sfere**
Ball Bearing operating system
- Cuoio**
Leather

BABY CORE by Jesper Voxnæs - LINER LOCK

FX-608 BL



- N690Co**
- HRC 58-60**
- Stone washed**
- 3 mm - 0.11"**
- 80 g - 2.82 oz**
- FRN® (Nylon® rinforzato con fibra di vetro) blu**
Blue FRN® (Fiberglass Reinforced Nylon®)

- Acciaio inox AISI 420 lucido**
Polished AISI 420 Stainless Steel
- Acciaio inox AISI 302 lucido**
Polished AISI 302 Stainless Steel
- Alluminio anodizzato arancione**
Orange anodized Aluminium
- Acciaio inox AISI 303 lucido**
Polished AISI 303 Stainless Steel
- Movimento con cuscinetti a sfere**
Ball Bearing operating system

BABY CORE by Jesper Voxnæs - LINER LOCK

FX-608 OR



- N690Co**
- HRC 58-60**
- Black idrogliker stone washed**
- 3 mm - 0.11"**
- 80 g - 2.82 oz**
- FRN® (Nylon® rinforzato con fibra di vetro) arancione**
ORANGE FRN® (Fiberglass Reinforced Nylon®)

- Acciaio inox AISI 420 Black idrogliker**
Black idrogliker AISI 420 Stainless Steel
- Acciaio inox AISI 302 black idrogliker**
Black idrogliker AISI 302 Stainless Steel
- Alluminio anodizzato nero**
Black anodized Aluminium
- Acciaio inox AISI 303 black idrogliker**
Black idrogliker AISI 303 Stainless Steel
- Movimento con cuscinetti a sfere**
Ball Bearing operating system

BABY CORE by Jesper Voxnæs - LINER LOCK

FX-608 R



- N690Co**
- HRC 58-60**
- Stone washed**
- 3 mm - 0.11"**
- 80 g - 2.82 oz**
- FRN® (Nylon® rinforzato con fibra di vetro) rosso**
Red FRN® (Fiberglass Reinforced Nylon®)

- Acciaio inox AISI 420 lucido**
Polished AISI 420 Stainless Steel
- Acciaio inox AISI 302 lucido**
Polished AISI 302 Stainless Steel
- Alluminio anodizzato grigio**
Gray anodized Aluminium
- Acciaio inox AISI 303 lucido**
Polished AISI 303 Stainless Steel
- Movimento con cuscinetti a sfere**
Ball Bearing operating system

BABY CORE by Jesper Voxnæs - LINER LOCK

FX-608 B



- N690Co**
- HRC 58-60**
- Black idrogliker stone washed**
- 3 mm - 0.11"**
- 80 g - 2.82 oz**
- FRN® (Nylon® rinforzato con fibra di vetro) nero**
Black FRN® (Fiberglass Reinforced Nylon®)

- Acciaio inox AISI 420 Black idrogliker**
Black idrogliker AISI 420 Stainless Steel
- Acciaio inox AISI 302 black idrogliker**
Black idrogliker AISI 302 Stainless Steel
- Alluminio anodizzato blu**
Blue anodized Aluminium
- Acciaio inox AISI 303 black idrogliker**
Black idrogliker AISI 303 Stainless Steel
- Movimento con cuscinetti a sfere**
Ball Bearing operating system

NEW!

CORE by Jesper Voxnæs - LINER LOCK

FX-604 OR



-  **N690Co**
-  **HRC 58-60**
-  **Top Shield® black**
-  **4 mm - 0.16"**
-  **135 g - 4.76 oz**
-  **FRN® (Nylon® rinforzato con fibra di vetro) arancione**
Orange FRN® (Fiberglass Reinforced Nylon®)

-  **Acciaio inox AISI 420 black idrogliider**
Black idrogliider AISI 420 Stainless Steel
-  **Acciaio inox AISI 302 black idrogliider**
Black idrogliider AISI 302 Stainless Steel
-  **Alluminio anodizzato nero**
Black anodized Aluminium
-  **Acciaio inox AISI 303 black idrogliider**
Black idrogliider AISI 303 Stainless Steel
-  **Movimento con cuscinetti a sfere**
Ball Bearing operating system

NEW!

CORE by Jesper Voxnæs - LINER LOCK

FX-604 R



-  **N690Co**
-  **HRC 58-60**
-  **Stone washed**
-  **4 mm - 0.16"**
-  **135 g - 4.76 oz**
-  **FRN® (Nylon® rinforzato con fibra di vetro) rosso**
Red FRN® (Fiberglass Reinforced Nylon®)





-  **Acciaio inox AISI 420 lucido**
Polished AISI 420 Stainless Steel
-  **Acciaio inox AISI 302 lucido**
Polished AISI 302 Stainless Steel
-  **Alluminio anodizzato grigio**
Gray anodized Aluminium
-  **Acciaio inox AISI 303 lucido**
Polished AISI 303 Stainless Steel
-  **Movimento con cuscinetti a sfere**
Ball Bearing operating system

CORE by Jesper Voxnæs - LINER LOCK

FX-604 OD



-  **N690Co**
-  **HRC 58-60**
-  **Top Shield® black**
-  **4 mm - 0.16"**
-  **135 g - 4.76 oz**
-  **FRN® (Nylon® rinforzato con fibra di vetro) verde OD**
OD Green FRN® (Fiberglass Reinforced Nylon®)

-  **Acciaio inox AISI 420 black idrogliider**
Black idrogliider AISI 420 Stainless Steel
-  **Acciaio inox AISI 302 black idrogliider**
Black idrogliider AISI 302 Stainless Steel
-  **Alluminio anodizzato nero**
Black anodized Aluminium
-  **Acciaio inox AISI 303 black idrogliider**
Black idrogliider AISI 303 Stainless Steel
-  **Movimento con cuscinetti a sfere**
Ball Bearing operating system

CORE by Jesper Voxnæs - LINER LOCK

FX-604 B









-  **N690Co**
-  **HRC 58-60**
-  **Top Shield® black**
-  **4 mm - 0.16"**
-  **135 g - 4.76 oz**
-  **FRN® (Nylon® rinforzato con fibra di vetro) nero**
Black FRN® (Fiberglass Reinforced Nylon®)

-  **Acciaio inox AISI 420 black idrogliider**
Black idrogliider AISI 420 Stainless Steel
-  **Acciaio inox AISI 302 black idrogliider**
Black idrogliider AISI 302 Stainless Steel
-  **Alluminio anodizzato arancione**
Orange anodized Aluminium
-  **Acciaio inox AISI 303 black idrogliider**
Black idrogliider AISI 303 Stainless Steel
-  **Movimento con cuscinetti a sfere**
Ball Bearing operating system

CORE by Jesper Voxnæs - LINER LOCK

FX-604



-  **N690Co**
-  **HRC 58-60**
-  **Stone washed**
-  **4 mm - 0.16"**
-  **135 g - 4.76 oz**
-  **FRN® (Nylon® rinforzato con fibra di vetro) nero**
Black FRN® (Fiberglass Reinforced Nylon®)

-  **Acciaio inox AISI 420 lucido**
Polished AISI 420 Stainless Steel
-  **Acciaio inox AISI 302 black idrogliider**
Black idrogliider AISI 302 Stainless Steel
-  **Alluminio anodizzato nero**
Black anodized Aluminium
-  **Acciaio inox AISI 303 lucido**
Polished AISI 303 Stainless Steel
-  **Movimento con cuscinetti a sfere**
Ball Bearing operating system

CORE by Jesper Voxnæs - LINER LOCK

FX-604 BL



- N690Co**
- HRC 58-60**
- Stone washed**
- 4 mm - 0.16"**
- 135 g - 4.76 oz**
- FRN® (Nylon® rinforzato con fibra di vetro) blu**
Blue FRN® (Fiberglass Reinforced Nylon®)

- Acciaio inox AISI 420 lucido**
Polished AISI 420 Stainless Steel
- Acciaio inox AISI 302 lucido**
Polished AISI 302 Stainless Steel
- Alluminio anodizzato arancione**
Orange anodized Aluminium
- Acciaio inox AISI 303 lucido**
Polished AISI 303 Stainless Steel
- Movimento con cuscinetti a sfere**
Ball Bearing operating system

NEW!

ITALICO by Antonio Di Gennaro - FRAME LOCK

FX-540 TIBL



- M390**
- HRC 59-61**
- Satinata**
Satin
- 3 mm - 0.11"**
- 90 g - 3.35 oz**
- Titanio anodizzato blu**
Blue anodized Titanium

- Titanio anodizzato blu**
Blue anodized Titanium
- Acciaio inox AISI 302 lucido**
Polished AISI 302 Stainless Steel
- Titanio anodizzato blu**
Blue anodized Titanium
- Acciaio inox AISI 303 lucido**
Polished AISI 303 Stainless Steel
- Movimento con cuscinetti a sfere**
Ball Bearing operating system
- Cuoio**
Leather

NEW!

ITALICO by Antonio Di Gennaro - FRAME LOCK

FX-540 TIB



- M390**
- HRC 59-61**
- PVD stone washed**
- 3 mm - 0.11"**
- 90 g - 3.1 oz**
- Titanio PVD stone washed**
PVD stone washed Titanium

- Titanio PVD stone washed**
PVD stone washed Titanium
- Acciaio inox AISI 302 PVD**
PVD AISI 302 Stainless Steel
- Titanio anodizzato bronzo**
Bronze anodized Titanium
- Acciaio inox AISI 303 PVD**
AISI 303 Stainless Steel PVD
- Movimento con cuscinetti a sfere**
Ball Bearing operating system
- Cuoio**
Leather

NEW!

ITALICO by Antonio Di Gennaro - LINER LOCK

FX-540 G100D



- M390**
- HRC 59-61**
- Satinata**
Satin
- 3 mm - 0.11"**
- 95 g - 3.35 oz**
- G10 verde OD a trama fine**
Fine texture OD Green G10

- Acciaio inox AISI 420 lucido**
Polished AISI 420 Stainless Steel
- Acciaio inox AISI 302 lucido**
Polished AISI 302 Stainless Steel
- Acciaio inox AISI 420 lucido**
Polished AISI 420 Stainless Steel
- Acciaio inox AISI 303 lucido**
Polished AISI 303 Stainless Steel
- Movimento con cuscinetti a sfere**
Ball Bearing operating system
- Nylon®**

NEW!

ITALICO by Antonio Di Gennaro - LINER LOCK

FX-540 NA



- M390**
- HRC 59-61**
- Satinata**
Satin
- 3 mm - 0.11"**
- 90 g - 3.1 oz**
- Micarta Naturale**
Natural Micarta

- Acciaio inox AISI 420 lucido**
Polished AISI 420 Stainless Steel
- Acciaio inox AISI 302 lucido**
Polished AISI 302 Stainless Steel
- Acciaio inox AISI 420 lucido**
Polished AISI 420 Stainless Steel
- Acciaio inox AISI 303 lucido**
Polished AISI 303 Stainless Steel
- Movimento con cuscinetti a sfere**
Ball Bearing operating system
- Nylon®**

RADIUS by Denis Simonutti - RADIUS LOCK

FX-550 DCFR





 Grosserosen™ pattern
Damacore DC18N
by Damasteel®
(Interno - Core: N11X™;
Layers: RWL34™+ PMC27™)

HRC 59-60
 Bagno in acido cloridrico
Etching with hydrochloric acid

 4 mm - 0.16"

 115 g - 4.06 oz

 Movimento con cuscinetti a sfere
Ball Bearing operating system

 Space Coral by Fat Carbon Materials
(Composto di fibra di carbonio e rame)
Space Coral by Fat Carbon Materials
(Carbon Fiber and Copper composite)

 Titanio anodizzato rosa
Pink anodized Titanium

 Titanio anodizzato rosa
Pink anodized Titanium

 Titanio PVD
PVD Titanium

 Titanio anodizzato rosa
Pink anodized Titanium

 Cuoio
Leather

RADIUS by Denis Simonutti - RADIUS LOCK

FX-550 CFB



 M390

HRC 59-61

 PVD (Physical Vapor Deposition)

 4 mm - 0.16"

 100 g - 3.52 oz

 Movimento con cuscinetti a sfere
Ball Bearing operating system
Snake Skin Copper by Fat Carbon Materials
(Composto di fibra di carbonio e rame)
Snake Skin Copper by Fat Carbon Materials
(Carbon Fiber and Copper composite)

 Titanio anodizzato rosa
Pink anodized Titanium

 Titanio anodizzato rosa
Pink anodized Titanium

 Titanio PVD
PVD Titanium

 Titanio anodizzato rosa
Pink anodized Titanium

 Movimento con cuscinetti a sfere
Ball Bearing operating system

 Cuoio
Leather

RADIUS by Denis Simonutti - RADIUS LOCK

FX-550 TiB



 M390

HRC 59-61

 PVD (Physical Vapor Deposition)

 4 mm - 0.16"

 140 g - 4.93 oz

 Titanio PVD
PVD Titanium

 Titanio anodizzato bronzo
Bronze anodized Titanium

 Titanio PVD
PVD Titanium

 Titanio PVD
PVD Titanium

 Titanio anodizzato bronzo
Bronze anodized Titanium

 Movimento con cuscinetti a sfere
Ball Bearing operating system

 Cuoio
Leather

RADIUS by Denis Simonutti - RADIUS LOCK

FX-550 Ti





 M390

HRC 59-61

 Satinata
Satin

 4 mm - 0.16"

 140 g - 4.93 oz

 Titanio sabbato
Bead blasted Titanium

 Titanio anodizzato bronzo
Bronze anodized Titanium

 Titanio anodizzato bronzo
Bronze anodized Titanium

 Titanio anodizzato bronzo
Bronze anodized Titanium

 Titanio anodizzato bronzo
Bronze anodized Titanium

 Movimento con cuscinetti a sfere
Ball Bearing operating system

 Cuoio
Leather

RADIUS by Denis Simonutti - RADIUS LOCK

FX-550 G10B



 N690Co

HRC 58-60

 Stone washed

 4 mm - 0.16"

 105 g - 3.7 oz

 G10 nero lavorato in 3D
3D mached black G10

 Acciaio Inox 420 lucido
Polished 420 Stainless Steel

 Acciaio inox AISI 302 lucido
Polished AISI 302 Stainless Steel

 G10 nero
Black G10

 Acciaio Inox 420 lucido
Polished 420 Stainless Steel

 Movimento con cuscinetti a sfere
Ball Bearing operating system

 Nylon®

RADIUS by Denis Simonutti - RADIUS LOCK FX-550 G100D



- N690Co**
- HRC** 58-60
- Stone washed
- 4 mm - 0.16"
- 105 g - 3.7 oz**
- G10 verde OD lavorato in 3D**
3D machined OD green G10

- Acciaio Inox 420 lucido**
Polished 420 Stainless Steel
- Acciaio inox AISI 302 lucido**
Polished AISI 302 Stainless Steel
- G10 arancione a trama fine**
Fine texture orange G10
- Acciaio Inox 420 lucido**
Polished 420 Stainless Steel
- Movimento con cuscinetti a sfere**
Ball Bearing operating system
- Nylon®**

NEW!



- M390**
- HRC** 59-61
- Satinata**
Satin
- 3 mm - 0.12"
- 45 g - 1.58 oz**

LIVRI - SLIP JOINT FX-273 MI

- Micarta di iuta naturale sagomata**
Contoured Natural Jute Micarta
- Acciaio inox AISI 420 satinato**
Satin AISI 420 Stainless Steel
- Acciaio inox AISI 303 lucido**
Polished AISI 303 Stainless Steel
- Cuoio**
Leather



- M390**
- HRC** 59-61
- Satinata**
Satin
- 3 mm - 0.12"
- 45 g - 1.58 oz**

LIVRI - SLIP JOINT FX-273

- Micarta verde OD sagomata**
Contoured OD Green Canvas Micarta
- Acciaio inox AISI 420 satinato**
Satin AISI 420 Stainless Steel
- Acciaio inox AISI 303 lucido**
Polished AISI 303 Stainless Steel
- Cuoio**
Leather



- M390**
- HRC** 59-61
- Satinata**
Satin
- 3 mm - 0.12"
- 45 g - 1.58 oz**

LIVRI - SLIP JOINT FX-273 CF

- Fibra di carbonio sagomata**
Contoured Carbon Fiber
- Acciaio inox AISI 420 satinato**
Satin AISI 420 Stainless Steel
- Acciaio inox AISI 303 lucido**
Polished AISI 303 Stainless Steel
- Cuoio**
Leather



- M390**
- HRC** 59-61
- Satinata**
Satin
- 3 mm - 0.12"
- 45 g - 1.58 oz**

LIVRI - SLIP JOINT FX-273 ZW

- Legno di Ziricote sagomato**
Contoured Ziricote wood
- Acciaio inox AISI 420 satinato**
Satin AISI 420 Stainless Steel
- Acciaio inox AISI 303 lucido**
Polished AISI 303 Stainless Steel
- Cuoio**
Leather





NEW!

LIBAR - SLIP JOINT

FX-582 MI







-  **M390**
-  **HRC 59-61**
-  **Satinata**
Satin
-  **3 mm - 0.12"**
-  **45 g - 1.58 oz**



-  **Micarta di iuta naturale sagomata**
Contoured Natural Yute Micarta
-  **Acciaio inox AISI 420 satinato**
Satin AISI 420 Stainless Steel
-  **Acciaio inox AISI 303 lucido**
Polished AISI 303 Stainless Steel
-  **Cuoio**
Leather

LIBAR - SLIP JOINT

FX-582



-  **M390**
-  **HRC 59-61**
-  **Satinata**
Satin
-  **3 mm - 0.12"**
-  **45 g - 1.58 oz**





-  **Micarta verde OD sagomata**
Contoured OD Green Canvas Micarta
-  **Acciaio inox AISI 420 satinato**
Satin AISI 420 Stainless Steel
-  **Acciaio inox AISI 303 lucido**
Polished AISI 303 Stainless Steel
-  **Cuoio**
Leather

LIBAR - SLIP JOINT

FX-582 CF



-  **M390**
-  **HRC 59-61**
-  **Satinata**
Satin
-  **3 mm - 0.12"**
-  **45 g - 1.58 oz**

-  **Fibra di carbonio sagomata**
Contoured Carbon Fiber
-  **Acciaio inox AISI 420 satinato**
Satin AISI 420 Stainless Steel
-  **Acciaio inox AISI 303 lucido**
Polished AISI 303 Stainless Steel
-  **Cuoio**
Leather

LIBAR - SLIP JOINT

FX-582 OL



-  **M390**
-  **HRC 59-61**
-  **Satinata**
Satin
-  **3 mm - 0.12"**
-  **45 g - 1.58 oz**





-  **Legno di Ulivo sagomato**
Contoured Olive Wood
-  **Acciaio inox AISI 420 satinato**
Satin AISI 420 Stainless Steel
-  **Acciaio inox AISI 303 lucido**
Polished AISI 303 Stainless Steel
-  **Cuoio**
Leather

BACK LOCK

573 CF



-  **440C**
-  **HRC 57-59**
-  **Satinata**
Satin
-  **2 mm - 0.08"**
-  **30 g - 1.05 oz**

-  **Fibra di carbonio sagomata**
Contoured Carbon Fiber
-  **Acciaio inox AISI 420 lucido**
Polished AISI 420 Stainless Steel
-  **Acciaio inox AISI 420 lucido**
Polished AISI 420 Stainless Steel
-  **Acciaio inox AISI 303 lucido**
Polished AISI 303 Stainless Steel
-  **Cuoio con trama a fibra di carbonio**
Leather with Carbon Fiber pattern

NAUTA - SLIP JOINT

FX-230 MI G





-  AISI 420 (1^a serie), BECUT (2^a serie)
AISI 420 (1^a series), BECUT (2nd series)
- HRC** 54-56 (AISI 420), 56-58 (BECUT)
-  Stone washed
-  4 mm - 0.16"





-  **62,5 g - 2.2 oz**
-  **Micarta di iuta verde sagomata**
Contoured Green Jute Micarta
-  **Acciaio inox AISI 420 satinato**
Satin AISI 420 Stainless Steel
-  **Acciaio inox AISI 303 lucido**
Polished AISI 303 Stainless Steel

NAUTA - SLIP JOINT

FX-230 MI



-  AISI 420 (1^a serie), BECUT (2^a serie)
AISI 420 (1^a series), BECUT (2nd series)
- HRC** 54-56 (AISI 420), 56-58 (BECUT)
-  Stone washed
-  4 mm - 0.16"





-  **62,5 g - 2.2 oz**
-  **Micarta di iuta nera sagomata**
Contoured Black Jute Micarta
-  **Acciaio inox AISI 420 satinato**
Satin AISI 420 Stainless Steel
-  **Acciaio inox AISI 303 lucido**
Polished AISI 303 Stainless Steel

NAUTA - SLIP JOINT

FX-230 MI BI



-  AISI 420 (1^a serie), BECUT (2^a serie)
AISI 420 (1^a series), BECUT (2nd series)
- HRC** 54-56 (AISI 420), 56-58 (BECUT)
-  Stone washed
-  4 mm - 0.16"





-  **62,5 g - 2.2 oz**
-  **Micarta di iuta bison sagomata**
Contoured Bison Jute Micarta
-  **Acciaio inox AISI 420 satinato**
Satin AISI 420 Stainless Steel
-  **Acciaio inox AISI 303 lucido**
Polished AISI 303 Stainless Steel

NAUTA - SLIP JOINT

FX-230 ZW



-  AISI 420 (1^a serie), BECUT (2^a serie)
AISI 420 (1^a series), BECUT (2nd series)
- HRC** 54-56 (AISI 420), 56-58 (BECUT)
-  Stone washed
-  4 mm - 0.16"

-  **62,5 g - 2.2 oz**
-  **Legno di Ziricote sagomato**
Contoured Ziricote wood
-  **Acciaio inox AISI 420 satinato**
Satin AISI 420 Stainless Steel
-  **Acciaio inox AISI 303 lucido**
Polished AISI 303 Stainless Steel

NAUTA - SLIP JOINT

FX-230 OL







-  AISI 420 (1^a serie), BECUT (2^a serie)
AISI 420 (1^a series), BECUT (2nd series)
- HRC** 54-56 (AISI 420), 56-58 (BECUT)
-  Stone washed
-  4 mm - 0.16"

-  **62,5 g - 2.2 oz**
-  **Legno di Ulivo sagomato**
Contoured Olive wood
-  **Acciaio inox AISI 420 satinato**
Satin AISI 420 Stainless Steel
-  **Acciaio inox AISI 303 lucido**
Polished AISI 303 Stainless Steel

Geco by Bastinelli - FRAME LOCK

FX-537 BR







-  **N690Co**
- HRC 58-60**
-  **Black idrogliker stone washed**
-  **3 mm - 0.11"**
-  **129 g - 4.55 oz**
-  **G10 nero sagomato**
Contoured black G10







-  **Titanio anodizzato bronzo**
Bronze anodized Titanium
-  **Acciaio inox AISI 420J2B black idrogliker stone washed** - Black idrogliker Stone washed AISI 420J2B Stainless Steel
-  **G10 nero**
black G10
-  **Acciaio inox AISI 304 rivestito al nichel**
Nickel plated AISI 304 Stainless Steel
-  **Movimento con cuscinetti a sfere**
Ball Bearing operating system
-  **Nylon®**

Geco by Bastinelli - FRAME LOCK

FX-537 SW







-  **N690Co**
- HRC 58-60**
-  **Coarse stone washed**
-  **3 mm - 0.11"**
-  **129 g - 4.55 oz**
-  **Micarta verde OD sagomata**
Contoured OD green Canvas Micarta







-  **Titanio stone washed**
Stone washed Titanium
-  **Acciaio inox AISI 420J2B stone washed**
Stone washed AISI 420J2B Stainless Steel
-  **G10 nero a trama fine**
Fine texture black G10
-  **Acciaio inox AISI 304 sabbiato**
Bead blasted AISI 304 Stainless Steel
-  **Movimento con cuscinetti a sfere**
Ball Bearing operating system
-  **Nylon®**

SHADOW by Bastinelli - FRAME LOCK

FX-533 CF







-  **ELMAX**
- HRC 58-60**
-  **Stone washed**
-  **4 mm - 0.16"**
-  **140 g - 4.93 oz**
-  **Fibra di carbonio lavorata in 3D**
3D machined Carbon fiber







-  **Titanio stone washed**
Stone washed Titanium
-  **Acciaio inox AISI 420J2B stone washed**
Stone washed AISI 420J2B Stainless Steel
-  **G10 nero**
Black G10
-  **Acciaio inox AISI 304 lucido**
Polished AISI 304 Stainless Steel
-  **Movimento con cuscinetti a sfere**
Ball Bearing operating system
-  **Cuoio**
Leather

SHADOW by Bastinelli - FRAME LOCK

FX-533 TI



-  **ELMAX**
- HRC 58-60**
-  **PVD Stone washed**
-  **4 mm - 0.16"**
-  **140 g - 4.93 oz**
-  **Titanio PVD Stone washed lavorato in 3D** - 3D machined PVD Stone washed Titanium

-  **Titanio PVD stone washed**
Stone washed PVD Titanium
-  **Acciaio inox AISI 420J2B PVD stone washed**
Stone washed PVD AISI 420J2B Stainless Steel
-  **Acciaio inox AISI 304 PVD**
PVD AISI 303 Stainless Steel
-  **Acciaio inox AISI 304 PVD**
PVD AISI 303 Stainless Steel
-  **Movimento con cuscinetti a sfere**
Ball Bearing operating system
-  **Cuoio**
Leather

ALASKAN HUNTER by Russ Kommer - LINER LOCK







FX-622 B









-  **BE CUT**
- HRC 56-58**
-  **Black idrogliker**
-  **3 mm - 0.12"**
-  **120 g - 4.23 oz**
-  **G10 nero sagomato**
Contoured Black G10

-  **Acciaio inox AISI 420 black idrogliker**
Black idrogliker AISI 420 Stainless Steel
-  **Acciaio inox AISI 420J2B black idrogliker**
Black idrogliker AISI 420J2B Stainless Steel
-  **Acciaio inox AISI 420 black idrogliker**
Black idrogliker AISI 420 Stainless Steel
-  **Acciaio inox AISI 420 black idrogliker**
Black idrogliker AISI 420 Stainless Steel
-  **Acciaio inox AISI 304 rivestito al nichel**
Nickel plated AISI 304 Stainless Steel





-  **N690Co**
-  **HRC 58-60**
-  **Stone washed**
-  **4 mm - 0.16"**
-  **180 g - 6.34 oz**
-  **Legno di Cocobolo lavorato in 3D**
3D machined Cocobolo Wood

-  **Acciaio inox AISI 420 lucido**
Polished AISI 420 Stainless Steel
-  **Acciaio inox AISI 420 lucido**
Polished AISI 420 Stainless Steel
-  **Acciaio inox AISI 420 lucido**
Polished AISI 420 Stainless Steel
-  **Acciaio inox AISI 420 lucido**
Polished AISI 420 Stainless Steel
-  **Acciaio inox AISI 304 lucido**
Polished AISI 304 Stainless Steel
-  **Cuoio**
Leather

EL CAPITAN by Tommaso Rumici - FRAME LOCK

SK-02 BR



-  **M390**
-  **HRC 59-61**
-  **Satinata**
Satin
-  **4 mm - 0.16"**
-  **176 g - 6.21 oz**
-  **Alluminio aeronautico 7075**
anodizzato marrone
Brown anodized 7075 Aircraft Aluminium





-  **Alluminio aeronautico 7075**
anodizzato marrone
Bronze anodized 7075 Aircraft Aluminium
-  **Acciaio inox AISI 420J2B placcato rame**
Copper plated AISI 420J2B Stainless Steel
-  **Alluminio aeronautico 7075**
anodizzato bronzo
Bronze anodized 7075 Aircraft Aluminium
-  **Acciaio inox AISI 303 placcato rame**
Copper plated AISI 303 Stainless Steel
-  **Nylon®**

EL CAPITAN by Tommaso Rumici - FRAME LOCK

SK-02 OD









-  **M390**
-  **HRC 59-61**
-  **Satinata**
Satin
-  **4 mm - 0.16"**
-  **176 g - 6.21 oz**
-  **Alluminio aeronautico 7075**
anodizzato verde OD
OD Green anodized 7075 Aircraft Aluminium

-  **Alluminio aeronautico 7075**
anodizzato verde OD
OD Green anodized 7075 Aircraft Aluminium
-  **Acciaio inox AISI 420J2B black idroglicer**
Black idroglicer 420J2B Stainless Steel
-  **Alluminio aeronautico 7075 anodizzato verde OD**
OD Green anodized 7075 Aircraft Aluminium
-  **Acciaio inox AISI 303 black idroglicer**
Black idroglicer AISI 303 Stainless Steel
-  **Nylon®**

EL CAPITAN by Tommaso Rumici - FRAME LOCK

SK-02 BSW



-  **D2**
-  **HRC 59-61**
-  **PVD Stone washed**
-  **4 mm - 0.16"**
-  **182 g - 6.42 oz**
-  **G10 nero a trama grezza**
Coarse texture Black G10

-  **Alluminio aeronautico 7075**
anodizzato nero
Black anodized 7075 Aircraft Aluminium
-  **Acciaio inox AISI 420J2B sabbiato**
Bead blasted AISI 420J2B Stainless Steel
-  **Alluminio aeronautico 7075**
anodizzato nero
Black anodized 7075 Aircraft Aluminium
-  **Acciaio inox AISI 303 sabbiato**
Bead blasted AISI 303 Stainless Steel
-  **Nylon®**

EL CAPITAN by Tommaso Rumici - FRAME LOCK

SK-02 PVD



-  **D2**
-  **HRC 59-61**
-  **PVD (Physical Vapor Deposition)**
-  **4 mm - 0.16"**
-  **182 g - 6.42 oz**
-  **Micarta verde OD**
OD Green Canvas Micarta

-  **Alluminio aeronautico 7075**
anodizzato grigio
Gray anodized 7075 Aircraft Aluminium
-  **Acciaio inox AISI 420J2B sabbiato**
Bead blasted AISI 420J2B Stainless Steel
-  **Alluminio aeronautico 7075**
anodizzato grigio
Gray anodized 7075 Aircraft Aluminium
-  **Acciaio inox AISI 303 sabbiato**
Bead blasted AISI 303 Stainless Steel
-  **Nylon®**

MOJO by Jens Anso - BACK LOCK

FX-306



- N690Co**
- HRC 58-60**
- Satinata**
Satin
- 3,5 mm - 0.14"**
- 175 g - 6.17 oz**
- Micarta verde sagomata**
Contoured green Canvas Micarta

- Acciaio inox AISI 420 lucido**
Polished AISI 420 Stainless Steel
- Acciaio inox AISI 420 lucido**
Polished AISI 420 Stainless Steel
- Acciaio inox AISI 420 lucido**
Polished AISI 420 Stainless Steel
- Acciaio inox AISI 303 lucido**
Polished AISI 303 Stainless Steel
- Cuoio**
Leather

MOJO by Jens Anso - BACK LOCK

FX-306 OL



- N690Co**
- HRC 58-60**
- Satinata**
Satin
- 3,5 mm - 0.14"**
- 175 g - 6.17 oz**
- Legno di Ulivo sagomato**
Contoured Olive wood

- Acciaio inox AISI 420 lucido**
Polished AISI 420 Stainless Steel
- Acciaio inox AISI 420 lucido**
Polished AISI 420 Stainless Steel
- Acciaio inox AISI 420 lucido**
Polished AISI 420 Stainless Steel
- Acciaio inox AISI 303 lucido**
Polished AISI 303 Stainless Steel
- Cuoio**
Leather

ZIGGY by Jens Anso - LINER LOCK

FX-308 CF



- N690Co**
- HRC 58-60**
- Satinata**
Satin
- 3,5 mm - 0.14"**
- 115 g - 4.05 oz**
- Fibra di carbonio lavorata in 3D**
3D machined Carbon Fiber

- Acciaio inox AISI 420 lucido**
Polished AISI 420 Stainless Steel
- Acciaio inox AISI 420J2B lucido**
Polished AISI 420J2B Stainless Steel
- G10 nero**
Black G10
- Acciaio inox AISI 304 lucido**
Polished AISI 304 Stainless Steel
- Movimento con cuscinetti a sfere**
Ball Bearing operating system
- Nylon®**

ZIGGY by Jens Anso - LINER LOCK

FX-308 CFB



- N690Co**
- HRC 58-60**
- Black idroglider stone washed**
- 3,5 mm - 0.14"**
- 115 g - 4.05 oz**
- Fibra di carbonio lavorata in 3D**
3D machined Carbon Fiber

- Acciaio inox AISI 420 black idroglider**
Black idroglider AISI 420 Stainless Steel
- Acciaio inox 420J2B black idroglider stone washed**
Black idroglider stone washed 420J2B Stainless Steel
- G10 nero**
Black G10
- Acciaio inox AISI 304 rivestito al nichel**
Nickel plated AISI 304 Stainless Steel
- Movimento con cuscinetti a sfere**
Ball Bearing operating system
- Nylon®**

ZIGGY by Jens Anso - LINER LOCK

FX-308 ZW









- N690Co**
- HRC 58-60**
- Satinata**
Satin
- 3,5 mm - 0.14"**
- 110 g - 3.88 oz**
- Legno di Ziricote lavorato in 3D**
3D machined Ziricote wood







- Acciaio inox AISI 420 lucido**
Polished AISI 420 Stainless Steel
- Acciaio inox AISI 420J2B lucido**
Polished AISI 420J2B Stainless Steel
- G10 nero**
Black G10
- Acciaio inox AISI 304 rivestito al nichel**
Nickel plated AISI 304 Stainless Steel
- Movimento con cuscinetti a sfere**
Ball Bearing operating system
- Nylon®**

TUR by Jesper Voxnæs - LINER LOCK

FX-528 B









-  **ELMAX**
-  **HRC 58-60**
-  **PVD (Physical Vapor Deposition)**
-  **3,5 mm - 0.14"**
-  **95 g - 3.35 oz**
-  **Fibra di carbonio sagomata**
Contoured Carbon fiber

-  **Acciaio inox AISI 420 black idroglicer**
Black idroglicer AISI 420 Stainless Steel
-  **Titanio anodizzato blu**
Blue anodized Titanium
-  **Acciaio inox AISI 420 PVD**
PVD AISI 420 Stainless Steel
-  **Titanio anodizzato blu**
Blue anodized Titanium
-  **Acciaio inox AISI 304 rivestito al nichel**
Nickel plated AISI 304 Stainless Steel
-  **Cuoio**
Leather

TUR by Jesper Voxnæs - LINER LOCK

FX-528



-  **ELMAX**
-  **HRC 58-60**
-  **Satinata**
Satin
-  **3,5 mm - 0.14"**
-  **95 g - 3.35 oz**
-  **Fibra di carbonio sagomata**
Contoured Carbon fiber







-  **Acciaio inox AISI 420**
AISI 420 Stainless Steel
-  **Titanio anodizzato bronzo**
Bronze anodized titanium
-  **Acciaio inox AISI 420 lucido**
Polished AISI 420 Stainless Steel
-  **Titanio anodizzato bronzo**
Bronze anodized titanium
-  **Acciaio inox AISI 304 lucido**
Polished AISI 304 Stainless Steel
-  **Cuoio**
Leather

TUR by Jesper Voxnæs - LINER LOCK

FX-523 B



-  **N690Co**
-  **HRC 58-60**
-  **Satinata**
Satin
-  **3,5 mm - 0.14"**
-  **100 g - 3.53 oz**
-  **G10 nero sagomato**
Contoured black G10







-  **Acciaio inox AISI 420 lucido**
Polished AISI 420 Stainless Steel
-  **Acciaio inox AISI 420J2B lucido**
Polished AISI 420J2B Stainless Steel
-  **Acciaio inox AISI 420 lucido**
Polished AISI 420 Stainless Steel
-  **G10 arancione**
Orange G10
-  **Acciaio inox AISI 304 lucido**
Polished AISI 304 Stainless Steel
-  **Nylon®**

TUR by Jesper Voxnæs - LINER LOCK

FX-523 OD







-  **N690Co**
-  **HRC 58-60**
-  **Satinata**
Satin
-  **3,5 mm - 0.14"**
-  **100 g - 3.53 oz**
-  **G10 verde OD sagomato**
Contoured OD green G10







-  **Acciaio inox AISI 420 lucido**
Polished AISI 420 Stainless Steel
-  **Acciaio inox AISI 420J2B lucido**
Polished AISI 420J2B Stainless Steel
-  **Acciaio inox AISI 420 lucido**
Polished AISI 420 Stainless Steel
-  **G10 nero**
Black G10
-  **Acciaio inox AISI 303 lucido**
Polished AISI 303 Stainless Steel
-  **Nylon®**

TUR by Jesper Voxnæs - LINER LOCK

FX-523 OR



-  **N690Co**
-  **HRC 58-60**
-  **Satinata**
Satin
-  **3,5 mm - 0.14"**
-  **100 g - 3.53 oz**
-  **G10 arancione sagomato**
Contoured Orange G10

-  **Acciaio inox AISI 420 lucido**
Polished AISI 420 Stainless Steel
-  **Acciaio inox AISI 420J2B lucido**
Polished AISI 420J2B Stainless Steel
-  **Acciaio inox AISI 420 lucido**
Polished AISI 420 Stainless Steel
-  **G10 nero**
Black G10
-  **Acciaio inox AISI 304 lucido**
Polished AISI 304 Stainless Steel
-  **Nylon®**

FLIPPER by Jens Anso - FRAME LOCK

FX-302



-  **N690Co**
-  **HRC 58-60**
-  **Satinata**
Satin
-  **4 mm - 0.16"**
-  **185 g - 6.52 oz**
-  **Titanio sabbiato lavorato in 3D**
3D machined Bead blasted Titanium







-  **Titanio sabbiato lavorato in 3D**
3D machined Bead blasted Titanium
-  **Acciaio inox AISI 420J2B anodizzato**
Anodized AISI 420J2B Stainless Steel
-  **G10 nero**
Black G10
-  **Acciaio inox AISI 303 lucido**
Polished AISI 303 Stainless Steel
-  **Movimento con cuscinetti a sfere**
Ball Bearing operating system
-  **Nylon®**

FLIPPER by Jens Anso - LINER LOCK

FX-302 ST



-  **N690Co**
-  **HRC 58-60**
-  **Satinata**
Satin
-  **4 mm - 0.16"**
-  **130 g - 4.58 oz**
-  **Legno di Santos lavorato in 3D**
3D machined Santos Wood

-  **Acciaio inox AISI 420 lucido**
Polished AISI 420 Stainless Steel
-  **Acciaio inox AISI 420J2B lucido**
Polished AISI 420J2B Stainless Steel
-  **G10 nero**
Black G10
-  **Acciaio inox AISI 303 black idrogliider**
Black idrogliider AISI 303 Stainless Steel
-  **Movimento con cuscinetti a sfere**
Ball Bearing operating system
-  **Nylon®**

PHOENIX by Tashi Bharucha - FRAME LOCK

FX-531 TI BR



-  **M390**
-  **HRC 59-61**
-  **Satinata**
Satin
-  **4 mm - 0.16"**
-  **150 g - 5.29 oz**
-  **Titanio anodizzato marrone**
Brown anodized Titanium







-  **Titanio anodizzato marrone**
Brown anodized Titanium
-  **Titanio anodizzato marrone**
Brown anodized Titanium
-  **Titanio anodizzato marrone**
Brown anodized Titanium
-  **Acciaio inox AISI 303 lucido**
Polished AISI 303 Stainless Steel
-  **Movimento con cuscinetti a sfere**
Ball Bearing operating system
-  **Cuoio**
Leather

PHOENIX by Tashi Bharucha - FRAME LOCK

FX-531 TI BL









-  **M390**
-  **HRC 59-61**
-  **Satinata**
Satin
-  **4 mm - 0.16"**
-  **150 g - 5.29 oz**
-  **Titanio anodizzato blu**
Blue anodized Titanium







-  **Titanio anodizzato blu**
Blue anodized Titanium
-  **Titanio anodizzato blu**
Blue anodized Titanium
-  **Titanio anodizzato blu**
Blue anodized Titanium
-  **Acciaio inox AISI 303 lucido**
Polished AISI 303 Stainless Steel
-  **Movimento con cuscinetti a sfere**
Ball Bearing operating system
-  **Cuoio**
Leather

PHOENIX by Tashi Bharucha - FRAME LOCK

FX-531 TI B



-  **M390**
-  **HRC 59-61**
-  **PVD (Physical Vapor Deposition)**
-  **4 mm - 0.16"**
-  **150 g - 5.29 oz**
-  **Titanio PVD**
PVD Titanium

-  **Titanio PVD**
PVD Titanium
-  **Titanio anodizzato blu**
Blue anodized Titanium
-  **Titanio PVD**
PVD Titanium
-  **Acciaio inox AISI 303 black idrogliider**
Black idrogliider AISI 303 Stainless Steel
-  **Movimento con cuscinetti a sfere**
Ball Bearing operating system
-  **Cuoio**
Leather



- N690Co**
- HRC 58-60**
- Stone washed**
- 4 mm - 0.16"**
- 185 g - 6.52 oz**
- Titanio sabbato lavorato in 3D**
3D machined Bead blasted Titanium

- Titanio sabbato lavorato in 3D**
3D machined Bead blasted Titanium
- Acciaio inox AISI 420J2B lucido**
Polished AISI 420J2B Stainless Steel
- Acciaio inox AISI 420 lucido**
Polished AISI 420 Stainless Steel
- Acciaio inox AISI 420 lucido**
Polished AISI 420 Stainless Steel
- Acciaio inox AISI 304 lucido**
Polished AISI 304 Stainless Steel
- Nylon®**

PELICAN by Kmaxrom - LINER LOCK

FX-534 B



- N690Co**
- HRC 58-60**
- Cerakote™ black**
- 4 mm - 0.16"**
- 160 g - 5.64 oz**
- G10 nero sagomato**
Contoured black G10

- Acciaio inox AISI 420 black idroglicer**
Black idroglicer AISI 420 Stainless Steel
- Acciaio inox AISI 302 black idroglicer**
Black idroglicer AISI 302 Stainless Steel
- Acciaio inox AISI 420 black idroglicer**
Black idroglicer AISI 420 Stainless Steel
- G10 verde OD**
OD green G10
- Acciaio inox AISI 304 rivestito al nichel**
Nickel plated AISI 304 Stainless Steel
- Nylon®**

PELICAN by Kmaxrom - LINER LOCK

FX-534 O



- N690Co**
- HRC 58-60**
- Stone washed**
- 4 mm - 0.16"**
- 160 g - 5.64 oz**
- G10 arancione sagomato**
Contoured orange G10

- Acciaio inox AISI 420 lucido**
Polished AISI 420 Stainless Steel
- Acciaio AISI 302 lucido**
Polished AISI 302 Stainless Steel
- Acciaio inox AISI 420 lucido**
Polished AISI 420 Stainless Steel
- G10 arancione**
Orange G10
- Acciaio inox AISI 304 lucido**
Polished AISI 304 Stainless Steel
- Nylon®**

PELICAN by Kmaxrom - LINER LOCK

FX-534



- N690Co**
- HRC 58-60**
- Stone washed**
- 4 mm - 0.16"**
- 160 g - 5.64 oz**
- G10 nero sagomato**
Contoured black G10

- Acciaio inox AISI 420 lucido**
Polished AISI 420 Stainless Steel
- Acciaio inox AISI 302 black idroglicer**
Black idroglicer AISI 302 Stainless Steel
- Acciaio inox AISI 420 lucido**
Polished AISI 420 Stainless Steel
- G10 arancione**
Orange G10
- Acciaio inox AISI 304 lucido**
Polished AISI 304 Stainless Steel
- Nylon®**

PELICAN by Kmaxrom - LINER LOCK

FX-534 CF



- N690Co**
- HRC 58-60**
- Cerakote™ black**
- 4 mm - 0.16"**
- 153 g - 5.39 oz**
- Fibra di carbonio sagomata**
Contoured Carbon Fiber





- Acciaio inox AISI 420 Black idroglicer**
Black idroglicer AISI 420 Stainless Steel
- Acciaio inox AISI 302 black idroglicer**
Black idroglicer AISI 302 Stainless Steel
- Acciaio inox AISI 420 Black idroglicer**
Black idroglicer AISI 420 Stainless Steel
- G10 nero**
Black G10
- Acciaio inox AISI 304 rivestito al nichel**
Nickel plated AISI 304 Stainless Steel
- Cuoio**
Leather

SLIM DRAGOTAC "PIEMONTES" by Bastinelli - FRICTION FOLDER

FX-518



-  **N690Co**
-  **HRC 58-60**
-  **Satinata**
Satin
-  **3 mm - 0.12"**
-  **45 g - 1.6 oz**





-  **FRN® (Nylon® rinforzato con fibra di vetro) nero**
Black FRN® (Fiberglass Reinforced Nylon®)
-  **Acciaio inox AISI 420 lucido**
Polished AISI 420 Stainless Steel
-  **Acciaio inox AISI 304 lucido**
Polished AISI 304 Stainless Steel
-  **Cuoio**
Leather

SLIM DRAGOTAC "PIEMONTES" by Bastinelli - FRICTION FOLDER

FX-518 O







-  **N690Co**
-  **HRC 58-60**
-  **Satinata**
Satin
-  **3 mm - 0.12"**
-  **45 g - 1.6 oz**





-  **FRN® (Nylon® rinforzato con fibra di vetro) arancione**
Orange FRN® (Fiberglass Reinforced Nylon®)
-  **Acciaio inox AISI 420 lucido**
Polished AISI 420 Stainless Steel
-  **Acciaio inox AISI 304 lucido**
Polished AISI 304 Stainless Steel
-  **Cuoio**
Leather

SLIM DRAGOTAC "PIEMONTES" by Bastinelli - FRICTION FOLDER

FX-518 GR



-  **N690Co**
-  **HRC 58-60**
-  **Satinata**
Satin
-  **3 mm - 0.12"**
-  **45 g - 1.6 oz**

-  **FRN® (Nylon® rinforzato con fibra di vetro) grigio**
Grey FRN® (Fiberglass Reinforced Nylon®)
-  **Acciaio inox AISI 420 lucido**
Polished AISI 420 Stainless Steel
-  **Acciaio inox AISI 304 lucido**
Polished AISI 304 Stainless Steel
-  **Cuoio**
Leather

SLIM DRAGOTAC "PIEMONTES" by Bastinelli - FRICTION FOLDER

FX-518 ZW



-  **N690Co**
-  **HRC 58-60**
-  **Satinata**
Satin
-  **3 mm - 0.12"**
-  **75 g - 2.65 oz**





-  **Legno di Zircote sagomato**
Contoured Zircote wood
-  **Acciaio inox AISI 420 lucido**
Polished AISI 420 Stainless Steel
-  **Acciaio inox AISI 304 lucido**
Polished AISI 304 Stainless Steel
-  **Cuoio**
Leather

DESERT FOX by Boris Manasherov - LINER LOCK

FX-520 CB



-  **N690Co**
-  **HRC 58-60**
-  **Satinata**
Satin
-  **4 mm - 0.16"**
-  **160 g - 5.64 oz**





-  **Legno di Cocobolo**
Cocobolo wood
-  **Acciaio inox AISI 420 lucido**
Polished AISI 420 Stainless Steel
-  **Acciaio inox AISI 420 lucido**
Polished AISI 420 Stainless Steel
-  **Acciaio inox AISI 303 lucido**
Polished AISI 303 Stainless Steel
-  **Cuoio**
Leather

BB DRAGO "PIEMONTE" by Bastinelli - FRICTION FOLDER

FX-519



-  **N690Co**
- HRC** 58-60
-  **Satinata**
Satin
-  **3 mm - 0.12"**
-  **30 g - 1.05 oz**





-  **FRN® (Nylon® rinforzato con fibra di vetro) nero**
Black FRN® (Fiberglass Reinforced Nylon®)
-  **Acciaio inox AISI 420 lucido**
Polished AISI 420 Stainless Steel
-  **Acciaio inox AISI 304 lucido**
Polished AISI 304 Stainless Steel
-  **Cuoio**
Leather

BB DRAGO "PIEMONTE" by Bastinelli - FRICTION FOLDER

FX-519 O



-  **N690Co**
- HRC** 58-60
-  **Satinata**
Satin
-  **3 mm - 0.12"**
-  **30 g - 1.05 oz**





-  **FRN® (Nylon® rinforzato con fibra di vetro) arancione**
Orange FRN® (Fiberglass Reinforced Nylon®)
-  **Acciaio inox AISI 420 lucido**
Polished AISI 420 Stainless Steel
-  **Acciaio inox AISI 304 lucido**
Polished AISI 304 Stainless Steel
-  **Cuoio**
Leather

BB DRAGO "PIEMONTE" by Bastinelli - FRICTION FOLDER

FX-519 GR



-  **N690Co**
- HRC** 58-60
-  **Satinata**
Satin
-  **3 mm - 0.12"**
-  **30 g - 1.05 oz**

-  **FRN® (Nylon® rinforzato con fibra di vetro) grigio**
Grey FRN® (Fiberglass Reinforced Nylon®)
-  **Acciaio inox AISI 420 lucido**
Polished AISI 420 Stainless Steel
-  **Acciaio inox AISI 304 lucido**
Polished AISI 304 Stainless Steel
-  **Cuoio**
Leather

BB DRAGO "PIEMONTE" by Bastinelli - FRICTION FOLDER

FX-519 ZW



-  **N690Co**
- HRC** 58-60
-  **Satinata**
Satin
-  **3 mm - 0.12"**
-  **50 g - 1.76 oz**

-  **Legno di Ziricote sagomato**
Contoured Ziricote wood
-  **Acciaio inox AISI 420 lucido**
Polished AISI 420 Stainless Steel
-  **Acciaio inox AISI 304 lucido**
Polished AISI 304 Stainless Steel
-  **Cuoio**
Leather

GUN HAMMER by Darrel Ralph - LINER LOCK

FX-120 TC



-  **N690Co**
- HRC** 58-60
-  **Black idrogliider**
-  **3 mm - 0.12"**
-  **110 g - 3.88 oz**
-  **G10 nero a trama grezza**
Coarse texture black G10







-  **Acciaio inox AISI 420 black idrogliider**
Black idrogliider AISI 420 Stainless Steel
-  **Acciaio inox 420J2B black idrogliider**
Black idrogliider 420J2B Stainless Steel
-  **Alluminio T6 6082 anodizzato nero**
Black anodized T6 6082 Aluminium
-  **Acciaio inox AISI 420 black idrogliider**
Black idrogliider AISI 420 Stainless Steel
-  **Acciaio inox AISI 304 rivestito al nichel**
Nickel plated AISI 304 Stainless Steel



KARAMBIT - FRAME LOCK

FX-599 TiC

-  **ELMAX**
-  **HRC 58-60**
-  **Top Shield® black**
-  **3 mm - 0.12"**
-  **80 g - 2.82 oz**
-  **Fibra di carbonio**
Carbon Fiber







-  **Titanio anodizzato bronzo**
Bronze anodized Titanium
-  **Titanio anodizzato bronzo**
Bronze anodized Titanium
-  **Titanio anodizzato bronzo**
Bronze anodized Titanium
-  **Acciaio inox AISI 303 black idrogli-der**
Black idrogli-der AISI 303 Stainless Steel
-  **Movimento con cuscinetti a sfere**
Ball Bearing operating system
-  **Cuoio**
Leather



KARAMBIT - FRAME LOCK

FX-599 TiCS



-  **ELMAX**
-  **HRC 58-60**
-  **Sabbia**
Bead blasted
-  **3 mm - 0.12"**
-  **80 g - 2.82 oz**
-  **Fibra di carbonio**
Carbon Fiber

-  **Titanio sabbia**
Bead blasted Titanium
-  **Titanio sabbia**
Bead blasted Titanium
-  **Titanio sabbia**
Bead blasted Titanium
-  **Acciaio inox AISI 303 lucido**
Polished AISI 303 Stainless Ste
-  **Movimento con cuscinetti a sfere**
Ball Bearing operating system
-  **Cuoio**
Leather



KARAMBIT - LINER LOCK

FX-599







-  **N690Co**
-  **HRC 58-60**
-  **Black idrogli-der**
-  **3 mm - 0.12"**
-  **100 g - 3.52 oz**
-  **G10 nero a trama grezza**
Coarse texture Black G10

-  **Acciaio inox AISI 420 black idrogli-der**
Black idrogli-der AISI 420 Stainless Steel
-  **Acciaio inox 420J2B black idrogli-der**
Black idrogli-der 420J2B Stainless Steel
-  **Alluminio aeronautico T6-6082 anodizzato nero**
Black anodized T6-6082 Aircraft Aluminium
-  **Acciaio inox AISI 420 black idrogli-der**
Black idrogli-der AISI 420 Stainless Steel
-  **Acciaio inox AISI 304 rivestito al nichel**
Nickel plated AISI 304 Stainless Steel
-  **Movimento con cuscinetti a sfere**
Ball Bearing operating system



KARAMBIT - LINER LOCK

FX-599 TK

-  **420C**
-  **HRC 54-56**
-  **Sabbia**
Bead blasted
-  **3 mm - 0.12"**
-  **110 g - 3.88 oz**
-  **G10 arancione a trama grezza**
Coarse texture Orange G10

-  **Acciaio inox AISI 420 lucido**
Polished AISI 420 Stainless Steel
-  **Acciaio inox 420J2B black idrogli-der**
Black idrogli-der 420J2B Stainless Steel
-  **Alluminio aeronautico T6-6082 anodizzato nero**
Black anodized T6-6082 Aircraft Aluminium
-  **Acciaio inox AISI 420 black idrogli-der**
Black idrogli-der AISI 420 Stainless Steel
-  **Acciaio inox AISI 304 rivestito al nichel**
Nickel plated AISI 304 Stainless Steel
-  **Movimento con cuscinetti a sfere**
Ball Bearing operating system

KARAMBIT - LINER LOCK (Con blocco di sicurezza L.A.W.K.S. - With L.A.W.K.S.® safety lock)

FX-599 RS









-  **N690Co**
-  **HRC 58-60**
-  **Cerakote™ black**
-  **3 mm - 0.12"**
-  **110 g - 3.88 oz**
-  **G10 nero a trama grezza**
Coarse texture Black G10

-  **Acciaio inox AISI 420 black idrogli-der**
Black idrogli-der AISI 420 Stainless Steel
-  **Acciaio inox 420J2B black idrogli-der**
Black idrogli-der 420J2B Stainless Steel
-  **Alluminio aeronautico T6-6082 anodizzato nero**
Black anodized T6-6082 Aircraft Aluminium
-  **Acciaio inox AISI 420 black idrogli-der**
Black idrogli-der AISI 420 Stainless Steel
-  **Acciaio inox AISI 304 rivestito al nichel**
Nickel plated AISI 304 Stainless Steel
-  **Movimento con cuscinetti a sfere**
Ball Bearing operating system

KARAMBIT - LINER LOCK (Con blocco di sicurezza L.A.W.K.S. - With L.A.W.K.S.® safety lock)

FX-599 RSY









-  **N690Co**
-  **HRC 58-60**
-  **Stone washed**
-  **3 mm - 0.12"**
-  **110 g - 3.88 oz**
-  **G10 giallo fosforescente a trama grezza**
Coarse texture glow in the dark yellow G10







-  **Acciaio inox AISI 420 lucido**
Polished AISI 420 Stainless Steel
-  **Acciaio inox AISI 420J2B lucido**
Polished AISI 420J2B Stainless Steel
-  **Alluminio aeronautico T6-6082 anodizzato rosso**
Red anodized T6-6082 Aircraft Aluminium
-  **Acciaio inox AISI 420 black idrogliider**
Black idrogliider AISI 420 Stainless Steel
-  **Acciaio inox AISI 304 lucido**
Polished AISI 304 Stainless Steel
-  **Movimento con cuscinetti a sfere**
Ball Bearing operating system

KARAMBIT - BACK LOCK (Con blocco di sicurezza - With safety lock)

FX-599 XT









-  **N690Co**
-  **HRC 58-60**
-  **Black idrogliider**
-  **3 mm - 0.12"**
-  **100 g - 3.52 oz**
-  **G10 nero a trama grezza**
Coarse texture Black G10
-  **Acciaio inox AISI 420 black idrogliider**
Black idrogliider AISI 420 Stainless Steel







-  **Acciaio inox 420J2B black idrogliider**
Black idrogliider 420J2B Stainless Steel
-  **Alluminio aeronautico T6-6082 anodizzato nero**
Black anodized T6-6082 Aircraft Aluminium
-  **Acciaio inox AISI 420 black idrogliider**
Black idrogliider AISI 420 Stainless Steel
-  **Acciaio inox AISI 304 rivestito al nichel**
Nickel plated AISI 304 Stainless Steel
-  **Movimento con cuscinetti a sfere**
Ball Bearing operating system
-  **Tungsteno**
Tungsten

KARAMBIT - BACK LOCK (Con blocco di sicurezza - With safety lock)

FX-599 XTTK









-  **420C**
-  **HRC 54-56**
-  **Sabbata**
Bead blasted
-  **3 mm - 0.12"**
-  **110 g - 3.88 oz**
-  **G10 arancione a trama grezza**
Coarse texture Orange G10
-  **Acciaio inox AISI 420 lucido**
Polished AISI 420 Stainless Steel







-  **Acciaio inox 420J2B sabbata**
Bead blasted 420J2B Stainless Steel
-  **Alluminio aeronautico T6-6082 anodizzato nero**
Black anodized T6-6082 Aircraft Aluminium
-  **Acciaio inox 420J2B sabbata**
Bead blasted 420J2B Stainless Steel
-  **Acciaio inox AISI 304 rivestito al nichel**
Nickel plated AISI 304 Stainless Steel
-  **Movimento con cuscinetti a sfere**
Ball Bearing operating system
-  **Tungsteno**
Tungsten

KARAMBIT - BACK LOCK (Con blocco di sicurezza - With safety lock)

FX-599 XTS



-  **N690Co**
-  **HRC 58-60**
-  **Cerakote™ black**
-  **3 mm - 0.12"**
-  **110 g - 3.88 oz**
-  **G10 nero a trama grezza**
Coarse texture Black G10
-  **Acciaio inox AISI 420 black idrogliider**
Black idrogliider AISI 420 Stainless Steel

-  **Acciaio inox 420J2B black idrogliider**
Black idrogliider 420J2B Stainless Steel
-  **Alluminio aeronautico T6-6082 anodizzato nero**
Black anodized T6-6082 Aircraft Aluminium
-  **Acciaio inox AISI 420 black idrogliider**
Black idrogliider AISI 420 Stainless Steel
-  **Acciaio inox AISI 304 rivestito al nichel**
Nickel plated AISI 304 Stainless Steel
-  **Movimento con cuscinetti a sfere**
Ball Bearing operating system
-  **Tungsteno**
Tungsten

CHIROPTERA by Richard Derespina - LINER LOCK

FX-590



-  **N690Co**
-  **HRC 58-60**
-  **Top Shield® black**
-  **3 mm - 0.12"**
-  **110 g - 3.88 oz**
-  **G10 nero a trama grezza**
Coarse texture black G10

-  **Acciaio inox AISI 420 Black idrogliider**
Black idrogliider AISI 420 Stainless Steel
-  **Acciaio inox AISI 420J2B black idrogliider**
Black idrogliider AISI 420J2B Stainless Steel
-  **Alluminio aeronautico T6-6082 anodizzato nero**
Black anodized T6-6082 Aircraft Aluminium
-  **Acciaio inox AISI 420 Black idrogliider**
Black idrogliider AISI 420 Stainless Steel
-  **Acciaio inox AISI 304 rivestito al nichel**
Nickel plated AISI 304 Stainless Steel
-  **Movimento con cuscinetti a sfere**
Ball Bearing operating system

THE DART by Doug Marcaida - LINER LOCK

FX-597







-  **N690Co**
-  **HRC 58-60**
-  **Black idroglider**
-  **3 mm - 0.12"**
-  **100 g - 3.52 oz**
-  **G10 nero a trama grezza**
Coarse texture black G10







-  **Acciaio inox AISI 420 black idroglider**
Black idroglider AISI 420 Stainless Steel
-  **Acciaio inox AISI 420J2B black idroglider**
Black idroglider AISI 420J2B Stainless Steel
-  **Alluminio aeronautico T6-6082 anodizzato nero**
Black anodized T6-6082 Aircraft Aluminium
-  **Acciaio inox AISI 420 black idroglider**
Black idroglider AISI 420 Stainless Steel
-  **Acciaio inox AISI 304 rivestito al nichel**
Nickel plated AISI 304 Stainless Steel
-  **Movimento con cuscinetti a sfere**
Ball Bearing operating system

THE DART by Doug Marcaida - LINER LOCK

FX-597 TK



-  **420C**
-  **HRC 54-56**
-  **Sabbziata**
Bead blasted
-  **3 mm - 0.12"**
-  **100 g - 3.52 oz**
-  **G10 arancione a trama grezza**
Coarse texture orange G10







-  **Acciaio inox AISI 420 black idroglider**
Black idroglider AISI 420 Stainless Steel
-  **Acciaio inox AISI 420J2B black idroglider**
Black idroglider AISI 420J2B Stainless Steel
-  **Alluminio aeronautico T6-6082 anodizzato nero**
Black anodized T6-6082 Aircraft Aluminium
-  **Acciaio inox AISI 420 black idroglider**
Black idroglider AISI 420 Stainless Steel
-  **Acciaio inox AISI 304 rivestito al nichel**
Nickel plated AISI 304 Stainless Steel
-  **Movimento con cuscinetti a sfere**
Ball Bearing operating system

THE DART by Doug Marcaida - LINER LOCK (Con blocco di sicurezza L.A.W.K.S. - With L.A.W.K.S.® safety lock)

FX-597 XTS



-  **N690Co**
-  **HRC 58-60**
-  **Black idroglider**
-  **3 mm - 0.12"**
-  **100 g - 3.52 oz**
-  **G10 nero a trama grezza**
Coarse texture black G10
-  **Acciaio inox AISI 420 black idroglider**
Black idroglider AISI 420 Stainless Steel

-  **Acciaio inox AISI 420J2B black idroglider**
Black idroglider AISI 420J2B Stainless Steel
-  **Alluminio aeronautico T6-6082 anodizzato nero**
Black anodized T6-6082 Aircraft Aluminium
-  **Acciaio inox AISI 420 black idroglider**
Black idroglider AISI 420 Stainless Steel
-  **Acciaio inox AISI 304 rivestito al nichel**
Nickel plated AISI 304 Stainless Steel
-  **Movimento con cuscinetti a sfere**
Ball Bearing operating system
-  **Tungsteno**
Tungsten

THE DART by Doug Marcaida - LINER LOCK (Con blocco di sicurezza L.A.W.K.S. - With L.A.W.K.S.® safety lock)

FX-597 XT



-  **N690Co**
-  **HRC 58-60**
-  **Black idroglider**
-  **3 mm - 0.12"**
-  **100 g - 3.52 oz**
-  **G10 nero a trama grezza**
Coarse texture black G10
-  **Acciaio inox AISI 420 black idroglider**
Black idroglider AISI 420 Stainless Steel

-  **Acciaio inox AISI 420J2B black idroglider**
Black idroglider AISI 420J2B Stainless Steel
-  **Alluminio aeronautico T6-6082 anodizzato nero**
Black anodized T6-6082 Aircraft Aluminium
-  **Acciaio inox AISI 420 black idroglider**
Black idroglider AISI 420 Stainless Steel
-  **Acciaio inox AISI 304 rivestito al nichel**
Nickel plated AISI 304 Stainless Steel
-  **Movimento con cuscinetti a sfere**
Ball Bearing operating system
-  **Tungsteno**
Tungsten

THE DART by Doug Marcaida - LINER LOCK (Con blocco di sicurezza L.A.W.K.S. - With L.A.W.K.S.® safety lock)

FX-597 XTTK



-  **420C**
-  **HRC 54-56**
-  **Sabbziata**
Bead blasted
-  **3 mm - 0.12"**
-  **100 g - 3.52 oz**
-  **G10 arancione a trama grezza**
Coarse texture orange G10
-  **Acciaio inox AISI 420 lucido**
Polished AISI 420 Stainless Steel







-  **Acciaio inox 420J2B sabbiziato**
Bead blasted 420J2B Stainless Steel
-  **Alluminio aeronautico T6-6082 anodizzato nero**
Black anodized T6-6082 Aircraft Aluminium
-  **Acciaio inox AISI 420 black idroglider**
Black idroglider AISI 420 Stainless Steel
-  **Acciaio inox AISI 304 lucido**
Polished AISI 304 Stainless Steel
-  **Movimento con cuscinetti a sfere**
Ball Bearing operating system
-  **Tungsteno**
Tungsten

MK TOOL by Doug Marcaida - BACK LOCK (Con blocco di sicurezza - With safety lock)**FX-800 MK**

18,5 cm - 7.28"



6,5 cm - 2.55"

-  **N690Co**
-  **HRC 58-60**
-  **Cerakote™ black**
-  **4 mm - 0.120.16"**
-  **130 g - 4.58 oz**
-  **G10 nero a trama grezza**
Coarse texture black G10

-  **Acciaio inox AISI 420 Black idroglider**
Black idroglider AISI 420 Stainless Steel
-  **Acciaio inox AISI 420J2B black idroglider**
Black idroglider AISI 420J2B Stainless Steel
-  **Alluminio aeronautico T6-6082 anodizzato nero**
Black anodized T6-6082 Aircraft Aluminium
-  **Acciaio inox AISI 304 rivestito al nichel**
Nickel plated AISI 304 Stainless Steel
-  **Movimento con cuscinetti a sfere**
Ball Bearing operating system
-  **Tungsteno**
Tungsten





BLACKBIRD by Bastinelli - LINER LOCK**FX-591 OD**

17 cm - 6.69"



6,5 cm - 2.55"

-  **N690Co**
-  **HRC 58-60**
-  **Black idroglider**
-  **3 mm - 0.12"**
-  **110 g - 3.88 oz**
-  **G10 verde OD sagomato**
Contoured OD green G10

-  **Acciaio inox AISI 420 black idroglider**
Black idroglider AISI 420 Stainless Steel
-  **Filo d'acciaio AISI 302 black idroglider**
Black idroglider AISI 302 Steel wireclip
-  **Alluminio 6082 anodizzato nero**
Black Anodized Aluminium 6082
-  **Acciaio inox AISI 304 rivestito al nichel**
Nickel plated AISI 304 Stainless Steel
-  **Movimento con cuscinetti a sfere**
Ball Bearing operating system



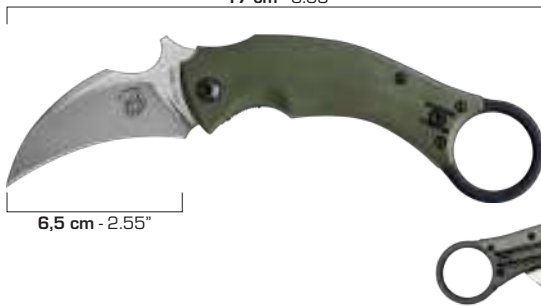

BLACKBIRD by Bastinelli - LINER LOCK**FX-591 ODSW**

17 cm - 6.69"



6,5 cm - 2.55"

-  **N690Co**
-  **HRC 58-60**
-  **Stone washed**
-  **3 mm - 0.12"**
-  **110 g - 3.88 oz**
-  **G10 verde OD sagomato**
Contoured OD green G10

-  **Acciaio inox AISI 420 black idroglider**
Black idroglider AISI 420 Stainless Steel
-  **Filo d'acciaio AISI 302 black idroglider**
Black idroglider AISI 302 Steel wireclip
-  **Alluminio T6 6082 anodizzato nero**
Black Anodized Aluminium T6 6082
-  **Acciaio inox AISI 304 rivestito al nichel**
Nickel plated AISI 304 Stainless Steel
-  **Movimento con cuscinetti a sfere**
Ball Bearing operating system

BLACKBIRD by Bastinelli - LINER LOCK**FX-591**

17 cm - 6.69"

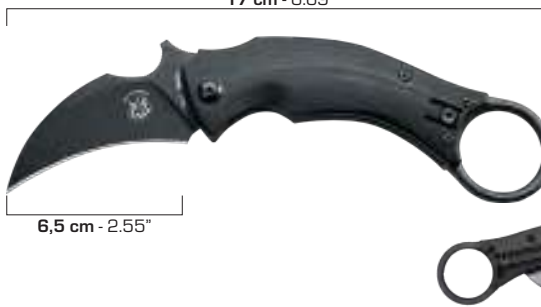

6,5 cm - 2.55"

-  **N690Co**
-  **HRC 58-60**
-  **Black idroglider**
-  **3 mm - 0.11"**
-  **110 g - 3.88 oz**
-  **G10 nero sagomato**
Contoured black G10

-  **Acciaio inox AISI 420 Black idroglider**
Black idroglider AISI 420 Stainless Steel
-  **Filo d'acciaio AISI 302 black idroglider**
Black idroglider AISI 302 Steel wireclip
-  **Alluminio T6 6082 anodizzato nero**
Black Anodized Aluminium T6 6082
-  **Acciaio inox AISI 304 rivestito al nichel**
Nickel plated AISI 304 Stainless Steel
-  **Movimento con cuscinetti a sfere**
Ball Bearing operating system





BLACKBIRD by Bastinelli - LINER LOCK**FX-591 TK**

17 cm - 6.69"



6,5 cm - 2.55"

-  **420C**
-  **HRC 54-56**
-  **Stone washed**
-  **3 mm - 0.11"**
-  **110 g - 3.88 oz**
-  **G10 blu sagomato**
Contoured blue G10





-  **Acciaio inox AISI 420 black idroglider**
Black idroglider AISI 420 Stainless Steel
-  **Filo d'acciaio AISI 302 sabbato**
Bead blasted AISI 302 Steel wireclip
-  **Alluminio T6 6082 anodizzato nero**
Black Anodized Aluminium T6 6082
-  **Acciaio inox AISI 304 rivestito al nichel**
Nickel plated AISI 304 Stainless Steel
-  **Movimento con cuscinetti a sfere**
Ball Bearing operating system



MINI-TA - LINER LOCK

FX-536







-  **1.4116**
-  **HRC 55-57**
-  **Sabbaiata**
Bead blasted
-  **2,5 mm - 0.10"**
-  **30 g - 1.05 oz**
-  **FRN® (Nylon® rinforzato con fibra di vetro) nero**
Black FRN® (Fiberglass Reinforced Nylon®)





-  **Acciaio inox AISI 420 lucido**
Polished AISI 420 Stainless Steel
-  **Acciaio inox AISI 420J2B lucido**
Polished AISI 420J2B Stainless Steel
-  **FRN® (Nylon® rinforzato con fibra di vetro) nero**
Black FRN® (Fiberglass Reinforced Nylon®)
-  **Acciaio inox AISI 304 lucido**
Polished AISI 304 Stainless Steel



MINI-TA - LINER LOCK

FX-536 CB

-  **1.4116**
-  **HRC 55-57**
-  **Sabbaiata**
Bead blasted
-  **2,5 mm - 0.10"**
-  **30 g - 1.05 oz**
-  **FRN® (Nylon® rinforzato con fibra di vetro) marrone coyote**
Coyote Brown FRN® (Fiberglass Reinforced Nylon®)





-  **Acciaio inox AISI 420 lucido**
Polished AISI 420 Stainless Steel
-  **Acciaio inox AISI 420J2B lucido**
Polished AISI 420J2B Stainless Steel
-  **FRN® (Nylon® rinforzato con fibra di vetro) marrone coyote**
Coyote Brown FRN® (Fiberglass Reinforced Nylon®)
-  **Acciaio inox AISI 304 lucido**
Polished AISI 304 Stainless Steel



MINI-TA - LINER LOCK

FX-536 OD

-  **1.4116**
-  **HRC 55-57**
-  **Sabbaiata**
Bead blasted
-  **2,5 mm - 0.10"**
-  **30 g - 1.05 oz**
-  **FRN® (Nylon® rinforzato con fibra di vetro) verde OD**
OD Green FRN® (Fiberglass Reinforced Nylon®)





-  **Acciaio inox AISI 420 lucido**
Polished AISI 420 Stainless Steel
-  **Acciaio inox AISI 420J2B lucido**
Polished AISI 420J2B Stainless Steel
-  **FRN® (Nylon® rinforzato con fibra di vetro) verde OD**
Coyote Brown FRN® (Fiberglass Reinforced Nylon®)
-  **Acciaio inox AISI 304 lucido**
Polished AISI 304 Stainless Steel



MINI-TA - LINER LOCK

FX-536 P







-  **1.4116**
-  **HRC 55-57**
-  **Sabbaiata**
Bead blasted
-  **2,5 mm - 0.10"**
-  **30 g - 1.05 oz**
-  **FRN® (Nylon® rinforzato con fibra di vetro) viola**
Purple FRN® (Fiberglass Reinforced Nylon®)





-  **Acciaio inox AISI 420 lucido**
Polished AISI 420 Stainless Steel
-  **Acciaio inox AISI 420J2B lucido**
Polished AISI 420J2B Stainless Steel
-  **FRN® (Nylon® rinforzato con fibra di vetro) viola**
Purple FRN® (Fiberglass Reinforced Nylon®)
-  **Acciaio inox AISI 304 lucido**
Polished AISI 304 Stainless Steel



MINI-TA - LINER LOCK

FX-536 G

-  **1.4116**
-  **HRC 55-57**
-  **Sabbaiata**
Bead blasted
-  **2,5 mm - 0.10"**
-  **30 g - 1.05 oz**
-  **FRN® (Nylon® rinforzato con fibra di vetro) verde**
Green FRN® (Fiberglass Reinforced Nylon®)





-  **Acciaio inox AISI 420 lucido**
Polished AISI 420 Stainless Steel
-  **Acciaio inox AISI 420J2B lucido**
Polished AISI 420J2B Stainless Steel
-  **FRN® (Nylon® rinforzato con fibra di vetro) verde**
Green FRN® (Fiberglass Reinforced Nylon®)
-  **Acciaio inox AISI 304 lucido**
Polished AISI 304 Stainless Steel



MINI-TA - LINER LOCK

FX-536 B

-  1.4116
-  HRC 55-57
-  Black idroglider
-  2,5 mm - 0.10"
-  30 g - 1.05 oz
-  FRN® (Nylon® rinforzato con fibra di vetro) nero
Black FRN® (Fiberglass Reinforced Nylon®)

-  Acciaio inox AISI 420 black idroglider
Black idroglider AISI 420 Stainless Steel
-  Acciaio inox AISI 420J2B black idroglider
Black idroglider AISI 420J2B Stainless Steel
-  FRN® (Nylon® rinforzato con fibra di vetro) nero
Black FRN® (Fiberglass Reinforced Nylon®)
-  Acciaio inox AISI 304 rivestito al nichel
Nickel plated AISI 304 Stainless Steel



MINI-TA - LINER LOCK

FX-536 CBB

-  1.4116
-  HRC 55-57
-  Black idroglider
-  2,5 mm - 0.10"
-  30 g - 1.05 oz
-  FRN® (Nylon® rinforzato con fibra di vetro) marrone coyote
Coyote Brown FRN® (Fiberglass Reinforced Nylon®)





-  Acciaio inox AISI 420 black idroglider
Black idroglider AISI 420 Stainless Steel
-  Acciaio inox AISI 420J2B black idroglider
Black idroglider AISI 420J2B Stainless Steel
-  FRN® (Nylon® rinforzato con fibra di vetro) marrone coyote
Coyote Brown FRN® (Fiberglass Reinforced Nylon®)
-  Acciaio inox AISI 304 rivestito al nichel
Nickel plated AISI 304 Stainless Steel



MINI-TA - LINER LOCK

FX-536 ODB



-  1.4116
-  HRC 55-57
-  Black idroglider
-  2,5 mm - 0.10"
-  30 g - 1.05 oz
-  FRN® (Nylon® rinforzato con fibra di vetro) verde OD
OD Green FRN® (Fiberglass Reinforced Nylon®)





-  Acciaio inox AISI 420 black idroglider
Black idroglider AISI 420 Stainless Steel
-  Acciaio inox AISI 420J2B black idroglider
Black idroglider AISI 420J2B Stainless Steel
-  FRN® (Nylon® rinforzato con fibra di vetro) verde OD
OD Green FRN® (Fiberglass Reinforced Nylon®)
-  Acciaio inox AISI 304 rivestito al nichel
Nickel plated AISI 304 Stainless Steel



MINI-TA - LINER LOCK

FX-536 PB

-  1.4116
-  HRC 55-57
-  Black idroglider
-  2,5 mm - 0.10"
-  30 g - 1.05 oz
-  FRN® (Nylon® rinforzato con fibra di vetro) viola
Purple FRN® (Fiberglass Reinforced Nylon®)





-  Acciaio inox AISI 420 black idroglider
Black idroglider AISI 420 Stainless Steel
-  Acciaio inox AISI 420J2B black idroglider
Black idroglider AISI 420J2B Stainless Steel
-  FRN® (Nylon® rinforzato con fibra di vetro) viola
Purple FRN® (Fiberglass Reinforced Nylon®)
-  Acciaio inox AISI 304 rivestito al nichel
Nickel plated AISI 304 Stainless Steel



MINI-TA - LINER LOCK

FX-536 GB

-  1.4116
-  HRC 55-57
-  Black idroglider
-  2,5 mm - 0.10"
-  30 g - 1.05 oz
-  FRN® (Nylon® rinforzato con fibra di vetro) verde
Green FRN® (Fiberglass Reinforced Nylon®)

-  Acciaio inox AISI 420 black idroglider
Black idroglider AISI 420 Stainless Steel
-  Acciaio inox AISI 420J2B black idroglider
Black idroglider AISI 420J2B Stainless Steel
-  FRN® (Nylon® rinforzato con fibra di vetro) verde
Green FRN® (Fiberglass Reinforced Nylon®)
-  Acciaio inox AISI 304 rivestito al nichel
Nickel plated AISI 304 Stainless Steel

MINI-KA - LINER LOCK

FX-535



1.4116

HRC 55-57



Sabbiata
Bead blasted



2,5 mm - 0.10"



30 g - 1.05 oz



FRN® (Nylon® rinforzato con fibra di vetro) nero
Black FRN® (Fiberglass Reinforced Nylon®)



Acciaio inox AISI 420 lucido

Polished AISI 420 Stainless Steel



Acciaio inox AISI 420J2B lucido

Polished AISI 420J2B Stainless Steel



FRN® (Nylon® rinforzato con fibra di vetro) nero
Black FRN® (Fiberglass Reinforced Nylon®)



Acciaio inox AISI 304 lucido

Polished AISI 304 Stainless Steel

MINI-KA - LINER LOCK

FX-535 BL



1.4116

HRC 55-57



Sabbiata
Bead blasted



2,5 mm - 0.10"



30 g - 1.05 oz



FRN® (Nylon® rinforzato con fibra di vetro) blu
Blue FRN® (Fiberglass Reinforced Nylon®)



Acciaio inox AISI 420 lucido

Polished AISI 420 Stainless Steel



Acciaio inox AISI 420J2B lucido

Polished AISI 420J2B Stainless Steel



FRN® (Nylon® rinforzato con fibra di vetro) blu
Blue FRN® (Fiberglass Reinforced Nylon®)



Acciaio inox AISI 304 lucido

Polished AISI 304 Stainless Steel

MINI-KA - LINER LOCK

FX-535 R



1.4116

HRC 55-57



Sabbiata
Bead blasted



2,5 mm - 0.10"



30 g - 1.05 oz



FRN® (Nylon® rinforzato con fibra di vetro) rosso
Red FRN® (Fiberglass Reinforced Nylon®)



Acciaio inox AISI 420 lucido

Polished AISI 420 Stainless Steel



Acciaio inox AISI 420J2B lucido

Polished AISI 420J2B Stainless Steel



FRN® (Nylon® rinforzato con fibra di vetro) rosso
Red FRN® (Fiberglass Reinforced Nylon®)



Acciaio inox AISI 304 lucido

Polished AISI 304 Stainless Steel

MINI-KA - LINER LOCK

FX-535 O



1.4116

HRC 55-57



Sabbiata
Bead blasted



2,5 mm - 0.10"



30 g - 1.05 oz



FRN® (Nylon® rinforzato con fibra di vetro) arancione
Orange FRN® (Fiberglass Reinforced Nylon®)



Acciaio inox AISI 420 lucido

Polished AISI 420 Stainless Steel



Acciaio inox AISI 420J2B lucido

Polished AISI 420J2B Stainless Steel



FRN® (Nylon® rinforzato con fibra di vetro) arancione
Orange FRN® (Fiberglass Reinforced Nylon®)



Acciaio inox AISI 304 lucido

Polished AISI 304 Stainless Steel

MINI-KA - LINER LOCK

FX-535 B



1.4116

HRC 55-57



Black idroglicer



2,5 mm - 0.10"



30 g - 1.05 oz



FRN® (Nylon® rinforzato con fibra di vetro) nero
Black FRN® (Fiberglass Reinforced Nylon®)



Acciaio inox AISI 420 black idroglicer

Black idroglicer AISI 420 Stainless Steel



Acciaio inox AISI 420J2B Black idroglicer

Black idroglicer AISI 440J2B Stainless Steel



FRN® (Nylon® rinforzato con fibra di vetro) nero
Black FRN® (Fiberglass Reinforced Nylon®)



Acciaio inox AISI 304 rivestito al nichel



Nickel plated AISI 304 Stainless Steel



MINI-KA - LINER LOCK

FX-535 BLB

-  **1.4116**
-  **HRC 55-57**
-  **Black idrogliider**
-  **2,5 mm - 0.10"**
-  **30 g - 1.05 oz**
-  **FRN® (Nylon® rinforzato con fibra di vetro) blu**
Blue FRN® (Fiberglass Reinforced Nylon®)



-  **Acciaio inox AISI 420 black idrogliider**
Black idrogliider AISI 420 Stainless Steel
-  **Acciaio inox AISI 420J2B Black idrogliider**
Black idrogliider AISI 420J2B Stainless Steel
-  **FRN® (Nylon® rinforzato con fibra di vetro) blu**
Blue FRN® (Fiberglass Reinforced Nylon®)
-  **Acciaio inox AISI 304 rivestito al nichel**
Nickel plated AISI 304 Stainless Steel



MINI-KA - LINER LOCK

FX-535 RB

-  **1.4116**
-  **HRC 55-57**
-  **Black idrogliider**
-  **2,5 mm - 0.10"**
-  **30 g - 1.05 oz**
-  **FRN® (Nylon® rinforzato con fibra di vetro) rosso**
Red FRN® (Fiberglass Reinforced Nylon®)

-  **Acciaio inox AISI 420 black idrogliider**
Black idrogliider AISI 420 Stainless Steel
-  **Acciaio inox AISI 420J2B Black idrogliider**
Black idrogliider AISI 420J2B Stainless Steel
-  **FRN® (Nylon® rinforzato con fibra di vetro) rosso**
Red FRN® (Fiberglass Reinforced Nylon®)
-  **Acciaio inox AISI 304 rivestito al nichel**
Nickel plated AISI 304 Stainless Steel



MINI-KA - LINER LOCK

FX-535 OB

-  **1.4116**
-  **HRC 55-57**
-  **Black idrogliider**
-  **2,5 mm - 0.10"**
-  **30 g - 1.05 oz**
-  **FRN® (Nylon® rinforzato con fibra di vetro) arancione**
Orange FRN® (Fiberglass Reinforced Nylon®)

-  **Acciaio inox AISI 420 black idrogliider**
Black idrogliider AISI 420 Stainless Steel
-  **Acciaio inox AISI 420J2B Black idrogliider**
Black idrogliider AISI 420J2B Stainless Steel
-  **FRN® (Nylon® rinforzato con fibra di vetro) arancione**
Orange FRN® (Fiberglass Reinforced Nylon®)
-  **Acciaio inox AISI 304 rivestito al nichel**
Nickel plated AISI 304 Stainless Steel



KARAMBIT - LINER LOCK

478



-  **N690Co**
-  **HRC 58-60**
-  **Sabbata**
Bead blasted
-  **3 mm - 0.12"**
-  **130 g - 4.58 oz**
-  **Alluminio aeronautico T6-6082 anodizzato grigio**
Gray anodized T6-6082 Aircraft Aluminium





-  **Acciaio inox AISI 420 lucido**
Polished AISI 420 Stainless Steel
-  **Acciaio inox AISI 420J2B Black idrogliider**
Black idrogliider AISI 420J2B Stainless Steel
-  **Alluminio aeronautico T6-6082 anodizzato nero**
Black anodized T6-6082 Aircraft Aluminium
-  **Acciaio inox AISI 420 black idrogliider**
Black idrogliider AISI 420 Stainless Steel
-  **Acciaio inox AISI 304 rivestito al nichel**
Nickel plated AISI 304 Stainless Steel



KARAMBIT - LINER LOCK

479

-  **N690Co**
-  **HRC 58-60**
-  **Black idrogliider**
-  **3 mm - 0.12"**
-  **130 g - 4.58 oz**
-  **G10 nero a trama grezza**
Coarse texture Black G10

-  **Acciaio inox AISI 420 black idrogliider**
Black idrogliider AISI 420 Stainless Steel
-  **Acciaio inox AISI 420J2B Black idrogliider**
Black idrogliider AISI 420J2B Stainless Steel
-  **Alluminio aeronautico T6-6082 anodizzato nero**
Black anodized T6-6082 Aircraft Aluminium
-  **Acciaio inox AISI 420 black idrogliider**
Black idrogliider AISI 420 Stainless Steel
-  **Acciaio inox AISI 304 rivestito al nichel**
Nickel plated AISI 304 Stainless Steel

KARAMBIT - LINER LOCK

479 TK









-  **420C**
-  **HRC 54-56**
-  **Sabbiata**
Bead blasted
-  **3 mm - 0.12"**
-  **130 g - 4.58 oz**
-  **G10 rosso a trama grezza**
Coarse texture red G10







-  **Acciaio inox AISI 420 lucido**
Polished AISI 420 Stainless Steel
-  **Acciaio inox AISI 420J2B black idroglicer**
Black idroglicer AISI 420 Stainless Steel
-  **Alluminio aeronautico T6-6082 anodizzato nero**
Black anodized T6-6082 Aircraft Aluminium
-  **Acciaio inox AISI 420 black idroglicer**
Black idroglicer AISI 420 Stainless Steel
-  **Acciaio inox AISI 304 rivestito al nichel**
Nickel plated AISI 304 Stainless Steel

EXTREME ELITE by Wilson Combat - LINER LOCK

FX-121 MC









-  **N690Co**
-  **HRC 58-60**
-  **PVD (Physical Vapor Deposition)**
-  **3 mm - 0.12"**
-  **110 g - 3.88 oz**
-  **G10 multi colore lavorato in 3D**
3D machined multicolor G10

-  **Acciaio inox AISI 420 black idroglicer**
Black idroglicer AISI 420 Stainless Steel
-  **Acciaio inox AISI 420J2B Black idroglicer**
Black idroglicer AISI 420J2B Stainless Steel
-  **Alluminio T6 6082 anodizzato nero**
Black anodized T6 6082 Aluminium
-  **Acciaio inox AISI 420 PVD**
PVD AISI 420 Stainless Steel
-  **Acciaio inox AISI 304 rivestito al nichel**
Nickel plated AISI 304 Stainless Steel
-  **Nylon®**

EXTREME ELITE by Wilson Combat - FRAME LOCK

FX-121 Ti









-  **N690Co**
-  **HRC 58-60**
-  **Satinata**
Satin
-  **3 mm - 0.12"**
-  **120 g - 4.23 oz**
-  **Titanio sabbiato lavorato in 3D**
3D machined Bead blasted Titanium

-  **Titanio sabbiato lavorato in 3D**
3D machined Bead blasted Titanium
-  **Acciaio inox AISI 420J2B sabbiato**
Bead blasted AISI 420J2B Stainless Steel
-  **Alluminio T6 6082 anodizzato blu**
Blue anodized T6 6082 Aluminium
-  **Acciaio inox AISI 420 lucido**
Polished AISI 420 Stainless Steel
-  **Acciaio inox AISI 304 sabbiato**
Bead blasted AISI 304 Stainless Steel
-  **Nylon®**

EXTREME ELITE by Wilson Combat - LINER LOCK

FX-121 CB









-  **N690Co**
-  **HRC 58-60**
-  **Satinata**
Satin
-  **3 mm - 0.12"**
-  **110 g - 3.88 oz**
-  **Legno di Cocobolo lavorato in 3D**
3D machined Cocobolo wood







-  **Acciaio inox AISI 420 lucido**
Polished AISI 420 Stainless Steel
-  **Acciaio inox AISI 420J2B lucido**
Polished AISI 420J2B Stainless Steel
-  **Alluminio T6 6082 anodizzato nero**
Black anodized T6 6082 Aluminium
-  **Acciaio inox AISI 420 lucido**
Polished AISI 420 Stainless Steel
-  **Acciaio inox AISI 304 lucido**
Polished AISI 304 Stainless Steel
-  **Nylon®**

EXTREME ELITE by Wilson Combat - LINER LOCK

FX-121 G10









-  **N690Co**
-  **HRC 58-60**
-  **PVD (Physical Vapor Deposition)**
-  **3 mm - 0.12"**
-  **110 g - 3.88 oz**
-  **G10 nero lavorato in 3D**
3D machined black G10

-  **Acciaio inox AISI 420 black idroglicer**
Black idroglicer AISI 420 Stainless Steel
-  **Acciaio inox AISI 420J2B Black idroglicer**
Black idroglicer AISI 420J2B Stainless Steel
-  **Alluminio T6 6082 anodizzato nero**
Black anodized T6 6082 Aluminium
-  **Acciaio inox AISI 420 PVD**
PVD AISI 420 Stainless Steel
-  **Acciaio inox AISI 304 rivestito al nichel**
Nickel plated AISI 304 Stainless Steel
-  **Nylon®**

ZERO by Jens Anso - BACK LOCK

FX-305 G



-  **N690Co**
-  **HRC 58-60**
-  **Satinata**
Satin
-  **3 mm - 0.12"**
-  **60 g - 2.11 oz**
-  **FRN® (Nylon® rinforzato con fibra di vetro) verde underbrush**
Underbrush Green FRN®
(Fiberglass Reinforced Nylon®)





-  **Acciaio inox AISI 420J2B lucido**
Polished AISI 420J2B Stainless Steel
-  **Acciaio inox AISI 420 lucido**
Polished AISI 420 Stainless Steel
-  **Acciaio inox AISI 420 lucido**
Polished AISI 420 Stainless Steel
-  **Acciaio inox AISI 304 lucido**
Polished AISI 304 Stainless Steel

ZERO by Jens Anso - BACK LOCK

FX-305



-  **N690Co**
-  **HRC 58-60**
-  **Satinata**
Satin
-  **3 mm - 0.12"**
-  **60 g - 2.11 oz**
-  **FRN® (Nylon® rinforzato con fibra di vetro) nero - Black FRN®** (Fiberglass Reinforced Nylon®)





-  **Acciaio inox AISI 420J2B lucido**
Polished AISI 420J2B Stainless Steel
-  **Acciaio inox AISI 420 lucido**
Polished AISI 420 Stainless Steel
-  **Acciaio inox AISI 420 lucido**
Polished AISI 420 Stainless Steel
-  **Acciaio inox AISI 304 lucido**
Polished AISI 304 Stainless Steel

PRO-HUNTER - LINER LOCK (Con blocco di sicurezza L.A.W.K.S. - With L.A.W.K.S.® safety lock)

FX-130 MGT









-  **N690Co**
-  **HRC 58-60**
-  **Black idrogliider**
-  **5 mm - 0.20"**
-  **215 g - 7.58 oz**
-  **Micarta verde OD lavorata in 3D**
3D machined OD green Canvas
Micarta

-  **Acciaio inox AISI 420 black idrogliider**
Black idrogliider AISI 420 Stainless Steel
-  **Alluminio T6 6082 anodizzato nero**
Black anodized T6 6082 Aluminium
-  **Acciaio inox AISI 420 black idrogliider**
Black idrogliider AISI 420 Stainless Steel
-  **Acciaio inox AISI 303 black idrogliider**
Black idrogliider AISI 303 Stainless Steel
-  **Cuoio; doppio assetto (coltello portatile anche come lama fissa)**
Leather; dual purpose (knife can be carried as a fixed blade)

PRO-HUNTER - LINER LOCK (Con blocco di sicurezza L.A.W.K.S. - With L.A.W.K.S.® safety lock)

FX-130 DW







-  **N690Co**
-  **HRC 58-60**
-  **Satinata**
Satin
-  **5 mm - 0.20"**
-  **200 g - 7.05 oz**
-  **Legno di Santos lavorato in 3D**
3D machined Santos wood

-  **Acciaio inox AISI 420 lucido**
Polished AISI 420 Stainless Steel
-  **Alluminio T6 6082 anodizzato nero**
Black anodized T6 6082 Aluminium
-  **Acciaio inox AISI 420 lucido**
Polished AISI 420 Stainless Steel
-  **Acciaio inox AISI 303 lucido**
Polished AISI 303 Stainless Steel
-  **Cuoio; doppio assetto (coltello portatile anche come lama fissa)**
Leather; dual purpose (knife can be carried as a fixed blade)

by Ron Lake - BACK LOCK (Con blocco di sicurezza - With safety lock)

FX-RL01 G10







-  **N690Co**
-  **HRC 58-60**
-  **Satinata**
Satin
-  **3 mm - 0.12"**
-  **120 g - 4.23 oz**
-  **G10 nero a trama fine**
Fine texture black G10

-  **Acciaio inox AISI 420 lucido**
Polished AISI 420 Stainless Steel
-  **Acciaio inox AISI 420 lucido**
Polished AISI 420 Stainless Steel
-  **Acciaio inox AISI 303 lucido**
Polished AISI 303 Stainless Steel
-  **Cuoio**
Leather

by Bob Terzuola - LINER LOCK

FX-525 DB



-  Dense Twist™ pattern
DS92X™, by Damasteel®
(Pattern: AISI 4140+ AISI 4340)
- HRC** 58-60
-  Bagno in acido cloridrico
Etching with hydrochloric acid
-  3 mm - 0.11"
-  100 g - 3.53 oz



-  **Legno di Bocote**
Bocote wood
-  **Acciaio inox AISI 420 lucido**
Polished AISI 420 Stainless Steel
-  **Acciaio inox AISI 420 lucido**
Polished AISI 420 Stainless Steel
-  **G10 nero**
Black G10
-  **Acciaio inox AISI 303 lucido**
Polished AISI 303 Stainless Steel
-  **Cuoio**
Leather

by Bob Terzuola - LINER LOCK

FX-525 B



-  N690Co
- HRC** 58-60
-  **Satinata**
Satin
-  3 mm - 0.11"
-  100 g - 3.53 oz
-  **Legno di Bocote**
Bocote wood

-  **Acciaio inox AISI 420 lucido**
Polished AISI 420 Stainless Steel
-  **Acciaio inox AISI 303 lucido**
Polished AISI 303 Stainless Steel
-  **G10 nero**
Black G10
-  **Acciaio inox AISI 303 lucido**
Polished AISI 303 Stainless Steel
-  **Cuoio**
Leather

by Bob Terzuola - LINER LOCK

FX-525 OL



-  N690Co
- HRC** 58-60
-  **Satinata**
Satin
-  3 mm - 0.11"
-  100 g - 3.53 oz
-  **Legno di Betulla**
Birch wood

-  **Acciaio inox AISI 420 lucido**
Polished AISI 420 Stainless Steel
-  **Acciaio inox AISI 303 lucido**
Polished AISI 303 Stainless Steel
-  **G10 nero**
Black G10
-  **Acciaio inox AISI 303 lucido**
Polished AISI 303 Stainless Steel
-  **Cuoio**
Leather

by Bob Terzuola - LINER LOCK

FX-525 BE







-  N690Co
- HRC** 58-60
-  **Satinata**
Satin
-  3 mm - 0.11"
-  100 g - 3.53 oz
-  **Legno di ulivo**
Olive wood

-  **Acciaio inox AISI 420 lucido**
Polished AISI 420 Stainless Steel
-  **Acciaio inox AISI 303 lucido**
Polished AISI 303 Stainless Steel
-  **G10 nero**
Black G10
-  **Acciaio inox AISI 303 lucido**
Polished AISI 303 Stainless Steel
-  **Cuoio**
Leather

by Bob Terzuola - FRAME LOCK

FX-525 Ti BL



-  N690Co
- HRC** 58-60
-  Stone washed
-  3 mm - 0.11"
-  100 g - 3.53 oz
-  **Titanio anodizzato blu**
Blue anodized Titanium

-  **Titanio anodizzato blu**
Blue anodized Titanium
-  **Titanio anodizzato blu**
Blue anodized Titanium
-  **Acciaio inox AISI 303 lucido**
Polished AISI 303 Stainless Steel
-  **Acciaio inox AISI 420 lucido**
Polished AISI 420 Stainless Steel
-  **Acciaio inox AISI 303 lucido**
Polished AISI 303 Stainless Steel
-  **Nylon®**

by Bob Terzuola - LINER LOCK

FX-515



- N690Co**
- HRC** 58-60
- Cerakote™ black**
- 3 mm - 0.11"**
- 110 g - 3.88 oz**
- G10 nero sagomato**
Contoured Black G10

- Acciaio inox AISI 420 black idroglied**
Black idroglied AISI 420 Stainless Steel
- Acciaio inox AISI 420J2B Black idroglied**
Black idroglied AISI 420J2B Stainless Steel
- G10 nero**
Black G10
- Acciaio inox AISI 303 black idroglied**
Black idroglied AISI 303 Stainless Steel
- Acciaio inox AISI 303 black idroglied**
Black idroglied AISI 303 Stainless Steel
- Nylon®**

by Bob Terzuola - LINER LOCK

FX-515 W



- N690Co**
- HRC** 58-60
- Satinata**
Satin
- 3 mm - 0.11"**
- 110 g - 3.88 oz**
- Legno di Ziricote sagomato**
Contoured Ziricote wood

- Acciaio inox AISI 420 lucido**
Polished AISI 420 Stainless Steel
- G10 nero**
Black G10
- Acciaio inox AISI 303 lucido**
Polished AISI 303 Stainless Steel
- Acciaio inox AISI 303 lucido**
Polished AISI 303 Stainless Steel
- Cuoio**
Leather

CHINOOK - LINER LOCK

474 ZW



- N690Co**
- HRC** 58-60
- Satinata**
Satin
- 3 mm - 0.12"**
- 100 g - 3.52 oz**

- Legno di Ziricote sagomato**
Contoured Ziricote wood
- Acciaio inox AISI 420 lucido**
Polished AISI 420 Stainless Steel
- Acciaio inox AISI 303 lucido**
Polished AISI 303 Stainless Steel
- Acciaio inox AISI 420 lucido**
Polished AISI 420 Stainless Steel
- Acciaio inox AISI 304 rivestito al nichel**
Nickel plated AISI 304 Stainless Steel

ANNIVERSARY KNIFE 1977-2017 - FRAME LOCK

FX-F2017 D



- Gysinge™ pattern DS93X™, by Damasteel® (Layers: RWL34+PMC27)**
- HRC** 56-58
- Bagno in acido cloridrico**
Etching with hydrochloric acid
- 3,5 mm - 0.14"**
- 123 g - 4.23 oz**
- Marble Carbon Fiber e mostrine in titanio anodizzato blu**
Marble Carbon Fiber and blue anodized Titanium bolsters

- Titanio anodizzato blu**
Blue anodized Titanium
- Titanio anodizzato blu**
Blue anodized Titanium
- Titanio anodizzato blu**
Blue anodized Titanium
- Titanio. Rondella in titanio anodizzato blu**
Titanium. Blue anodized Titanium washer
- Movimento con cuscinetti a sfere**
Ball Bearing operating system

ANNIVERSARY KNIFE 1977-2017 - FRAME LOCK

FX-F2017



- M390**
- HRC** 59-61
- Satinata**
Satin
- 3,5 mm - 0.14"**
- 120 g - 4.23 oz**
- Marble Carbon Fiber e mostrine in titanio sabbato**
Marble Carbon Fiber and bead blasted Titanium bolsters



- Titanio sabbato**
Bead blasted Titanium
- Titanio sabbato**
Bead blasted Titanium
- Titanio sabbato**
Bead blasted Titanium
- Titanio. Rondella in titanio anodizzato blu**
Titanium. Blue anodized Titanium washer
- Movimento con cuscinetti a sfere**
Ball Bearing operating system
- Cuoio con trama a fibra di carbonio**
Leather with Carbon Fiber pattern

FOREST - BACK LOCK

576RT



-  N690Co
- HRC** 58-60
-  Satinata
Satin
-  3,5 mm - 0.14"
-  230 g - 8.11 oz



-  **Legno di radica di Ambonia; mostrine in acciaio inox AISI 430 lucido**
Ambonya burl wood; Polished AISI 430 Stainless Steel bolsters
-  **Acciaio inox AISI 420 lucido**
Polished AISI 420 Stainless Steel
-  **Cuoio**
Leather

FOREST - BACK LOCK

577RT



-  N690Co
- HRC** 58-60
-  Satinata
Satin
-  4 mm - 0.16"
-  330 g - 11.64 oz





-  **Legno di radica di Ambonia; mostrine in acciaio inox AISI 430 lucido**
Ambonya burl wood; Polished AISI 430 Stainless Steel bolsters
-  **Acciaio inox AISI 420 lucido**
Polished AISI 420 Stainless Steel
-  **Cuoio**
Leather

FOREST PAKKAWOOD - BACK LOCK

575PW



-  N690Co
- HRC** 58-60
-  Satinata
Satin
-  3 mm - 0.12"
-  120 g - 4.23 oz





-  **Legno Pakkawood; mostrine in acciaio inox AISI 430 lucido**
Pakkawood; Polished AISI 430 Stainless Steel bolsters
-  **Acciaio inox AISI 420 lucido**
Polished AISI 420 Stainless Steel
-  **Ottone lucido**
Polished Brass
-  **Nylon®**

FOREST PAKKAWOOD - BACK LOCK

576PW





-  N690Co
- HRC** 58-60
-  Satinata
Satin
-  3,5 mm - 0.14"
-  230 g - 8.11 oz

-  **Legno Pakkawood; mostrine in acciaio inox AISI 430 lucido**
Pakkawood; Polished AISI 430 Stainless Steel bolsters
-  **Acciaio inox AISI 420 lucido**
Polished AISI 420 Stainless Steel
-  **Ottone lucido**
Polished Brass
-  **Nylon®**

FOREST - BACK LOCK

576ML



-  N690Co
- HRC** 58-60
-  Satinata
Satin
-  3,5 mm - 0.14"
-  125 g - 4.40 oz

-  **Micarta nera**
Black Canvas Micarta
-  **Acciaio inox AISI 420 lucido**
Polished AISI 420 Stainless Steel
-  **Ottone lucido**
Polished Brass
-  **Nylon®**

FOREST - BACK LOCK

577ML



-  **N690Co**
- HRC 58-60**
-  **Satinata**
Satin
-  **4 mm - 0.16"**
-  **200 g - 7.05 oz**





-  **Micarta nera**
Black Canvas Micarta
-  **Acciaio inox AISI 420 lucido**
Polished AISI 420 Stainless Steel
-  **Ottone lucido**
Polished Brass
-  **Nylon®**

BACK LOCK

500 G



-  **SANDVIK 12C27**
- HRC 56-58**
-  **Satinata**
Satin
-  **3 mm - 0.11"**
-  **70 g - 2.46 oz**



-  **G10 verde OD sagomato**
Contoured OD green G10
-  **Acciaio inox AISI 420 lucido**
Polished AISI 420 Stainless Steel
-  **Acciaio inox AISI 420 lucido**
Polished AISI 420 Stainless Steel
-  **Acciaio inox AISI 303 lucido**
Polished AISI 303 Stainless Steel
-  **Cuoio**
Leather

BACK LOCK

500 O



-  **SANDVIK 12C27**
- HRC 56-58**
-  **Satinata**
Satin
-  **3 mm - 0.11"**
-  **70 g - 2.46 oz**





-  **G10 arancione sagomato**
Contoured orange G10
-  **Acciaio inox AISI 420 lucido**
Polished AISI 420 Stainless Steel
-  **Acciaio inox AISI 420 lucido**
Polished AISI 420 Stainless Steel
-  **Acciaio inox AISI 303 lucido**
Polished AISI 303 Stainless Steel
-  **Cuoio**
Leather

BACK LOCK

500 B



-  **SANDVIK 12C27**
- HRC 56-58**
-  **Satinata**
Satin
-  **3 mm - 0.11"**
-  **70 g - 2.46 oz**





-  **G10 nero sagomato**
Contoured black G10
-  **Acciaio inox AISI 420 lucido**
Polished AISI 420 Stainless Steel
-  **Acciaio inox AISI 420 lucido**
Polished AISI 420 Stainless Steel
-  **Acciaio inox AISI 303 lucido**
Polished AISI 303 Stainless Steel
-  **Cuoio**
Leather

SAILING KNIFE - LINER LOCK

233



-  **AISI 420C**
- HRC 54-56**
-  **Satinata**
Satin
-  **3 mm - 0.12"**
-  **120 g - 4.23 oz**

-  **Alluminio T6 6082 anodizzato blu**
Blue anodized T6 6082 Aluminium
-  **Acciaio inox AISI 420 lucido**
Polished AISI 420 Stainless Steel
-  **Acciaio inox AISI 420 lucido**
Polished AISI 420 Stainless Steel
-  **Acciaio inox AISI 304 lucido**
Polished AISI 304 Stainless Steel
-  **Acciaio inox AISI 420 lucido**
Polished AISI 420 Stainless Steel

ORESTE FRATI DAMASCUS - BACK LOCK

500D



 Super Dense Twist™ pattern DS93X™, by Damasteel® (Layers: RWL34+ PMC27)

HRC 58-60

 **Bagno in acido cloridrico**
Etching with hydrochloric acid

 **3 mm - 0.12"**

 **135 g - 4.76 oz**

 **Legno di radica di Ambonia; mostrine in alpacca**
Ambonya burl wood;
Nickel silver bolsters

 **Acciaio inox AISI 420 lucido**
Polished AISI 420 Stainless Steel

 **Cuoio**
Leather

ORESTE FRATI DAMASCUS - BACK LOCK

500D/1





 Super Dense Twist™ pattern DS93X™, by Damasteel® (Layers: RWL34+ PMC27)

HRC 58-60

 **Bagno in acido cloridrico**
Etching with hydrochloric acid

 **3 mm - 0.12"**

 **135 g - 4.76 oz**

 **Legno di radica di Ambonia; mostrine in alpacca**
Ambonya burl wood;
Nickel silver bolsters

 **Acciaio inox AISI 420 lucido**
Polished AISI 420 Stainless Steel

 **Cuoio**
Leather

Confezione espositiva inclusa
Included display packaging

ORESTE FRATI DAMASCUS - LINER LOCK

2499DA





 Super Dense Twist™ pattern DS93X™, by Damasteel® (Layers: RWL34+ PMC27)

HRC 58-60

 **Bagno in acido cloridrico**
Etching with hydrochloric acid

 **3 mm - 0.12"**

 **90 g - 3.17 oz**

 **Legno di radica di Ambonia**
Ambonya burl wood

 **Acciaio inox AISI 420 lucido**
Polished AISI 420 Stainless Steel

 **Acciaio inox AISI 303 lucido**
Polished AISI 303 Stainless Steel

 **Acciaio inox AISI 420 lucido**
Polished AISI 420 Stainless Steel

 **Acciaio inox AISI 304 lucido**
Polished AISI 304 Stainless Steel

ORESTE FRATI DAMASCUS - LINER LOCK

2499DB



 Super Dense Twist™ pattern DS93X™, by Damasteel® (Layers: RWL34+ PMC27)

HRC 58-60

 **Bagno in acido cloridrico**
Etching with hydrochloric acid

 **3 mm - 0.12"**

 **90 g - 3.17 oz**

 **Legno di Betulla**
Birch wood

 **Acciaio inox AISI 420 lucido**
Polished AISI 420 Stainless Steel

 **Acciaio inox AISI 303 lucido**
Polished AISI 303 Stainless Steel

 **Acciaio inox AISI 420 lucido**
Polished AISI 420 Stainless Steel

 **Acciaio inox AISI 304 lucido**
Polished AISI 304 Stainless Steel

by Allen Elishewitz - LINER LOCK

456/2DOL



 Super Dense Twist™ pattern DS93X™, by Damasteel® (Layers: RWL34+ PMC27)

HRC 58-60

 **Bagno in acido cloridrico**
Etching with hydrochloric acid

 **3 mm - 0.12"**

 **95 g - 3.35 oz**

 **Legno di Ulivo**
Olive wood

 **Acciaio inox AISI 420 lucido**
Polished AISI 420 Stainless Steel

 **Acciaio inox AISI 303 lucido**
Polished AISI 303 Stainless Steel

 **Acciaio inox AISI 420 lucido**
Polished AISI 420 Stainless Steel

 **Acciaio inox AISI 304 lucido**
Polished AISI 304 Stainless Steel

 **Nylon®**

FOX ELITE - LINER LOCK

273 OL



N690Co



HRC 58-60



Satinata
Satin



3 mm - 0.12"



95 g - 3.35 oz



Legno di Ulivo; mostrine in acciaio inox AISI 304
Olive wood; AISI 304 Stainless Steel bolsters



Acciaio inox AISI 420 lucido
Polished AISI 420 Stainless Steel



Acciaio inox AISI 303 lucido
Polished AISI 303 Stainless Steel



Acciaio inox AISI 420 lucido
Polished AISI 420 Stainless Steel



Acciaio inox AISI 304 lucido
Polished AISI 304 Stainless Steel

FOX ELITE - LINER LOCK

273 DOL

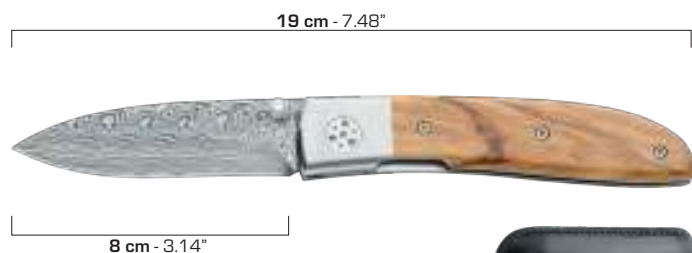

Super Dense Twist™ pattern DS93X™, by Damasteel® (Layers: RWL34+ PMC27)



HRC 58-60



Bagno in acido cloridrico
Etching with hydrochloric acid



3 mm - 0.12"



95 g - 3.35 oz



Legno di Ulivo; mostrine in acciaio inox AISI 304
Olive wood; AISI 304 Stainless Steel bolsters



Acciaio inox AISI 420 lucido
Polished AISI 420 Stainless Steel



Acciaio inox AISI 303 lucido
Polished AISI 303 Stainless Steel



Acciaio inox AISI 420 lucido
Polished AISI 420 Stainless Steel



Acciaio inox AISI 304 lucido
Polished AISI 304 Stainless Steel



Cuoio
Leather

FOX ELITE - LINER LOCK

271 OL

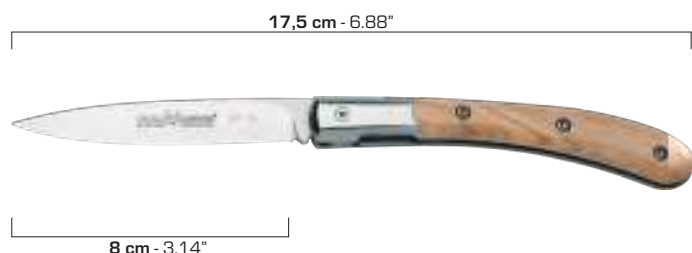

N690Co



HRC 58-60



Satinata
Satin



2,5 mm - 0.10"



47 g - 1.65 oz



Legno di Ulivo; mostrine in acciaio inox AISI 304
Olive wood; AISI 304 Stainless Steel bolsters



Acciaio inox AISI 420 lucido
Polished AISI 420 Stainless Steel



Acciaio inox AISI 420 lucido
Polished AISI 420 Stainless Steel



Acciaio inox AISI 304 lucido
Polished AISI 304 Stainless Steel

FOX ELITE - LINER LOCK

271 DOL



Rose™ pattern DS93X™, by Damasteel® (Layers: RWL34+ PMC27)



HRC 58-60



Bagno in acido cloridrico
Etching with hydrochloric acid



2,5 mm - 0.10"



47 g - 1.65 oz



Legno di Ulivo; mostrine in acciaio inox AISI 304
Olive wood; AISI 304 Stainless Steel bolsters



Acciaio inox AISI 420 lucido
Polished AISI 420 Stainless Steel



Acciaio inox AISI 420 lucido
Polished AISI 420 Stainless Steel



Acciaio inox AISI 304 lucido
Polished AISI 304 Stainless Steel



Cuoio
Leather

FOX ELITE by Alain Descy - LINER LOCK

270 OL



N690Co



HRC 58-60



Satinata
Satin



3 mm - 0.12"



66 g - 2.32 oz



Legno di Ulivo
Olive wood



Acciaio inox AISI 420 lucido
Polished AISI 420 Stainless Steel



Acciaio inox AISI 420 lucido
Polished AISI 420 Stainless Steel









Acciaio inox AISI 304 lucido
Polished AISI 304 Stainless Steel

PROJECT - LINER LOCK

1494RT



-  **AISI 440C**
-  **HRC 57-59**
-  **Satinata**
Satin
-  **3 mm - 0.12"**
-  **90 g - 3.17 oz**
-  **Legno di radica di Tuja**
Tuja briar wood

-  **Acciaio inox AISI 420 lucido**
Polished AISI 420 Stainless Steel
-  **Acciaio inox AISI 420 lucido**
Polished AISI 420 Stainless Steel
-  **Acciaio inox AISI 420 lucido**
Polished AISI 420 Stainless Steel
-  **Cuoio**
Leather

SILVER COLLECTION - BACK LOCK

594



-  **N690Co**
-  **HRC 58-60**
-  **Satinata**
Satin
-  **3,5 mm - 0.14"**
-  **160 g - 5.64 oz**





-  **Legno di palissandro; mostrine in alpaca lucido**
Palissander wood; Polished Nickel Silver bolsters
-  **Acciaio inox AISI 420 lucido**
Polished AISI 420 Stainless Steel
-  **Cuoio**
Leather

MY ONE - FRONT LOCK

279 CE



-  **N690Co**
-  **HRC 58-60**
-  **Satinata**
Satin
-  **3 mm - 0.12"**
-  **70 g - 2.46 oz**

-  **Corno di cervo**
Stag horn
-  **Acciaio inox AISI 420 lucido**
Polished AISI 420 Stainless Steel
-  **Acciaio inox AISI 420 lucido**
Polished AISI 420 Stainless Steel
-  **Acciaio inox AISI 304 lucido**
Polished AISI 304 Stainless Steel
-  **Cuoio**
Leather

MY ONE - FRONT LOCK

279 OL



-  **N690Co**
-  **HRC 58-60**
-  **Satinata**
Satin
-  **3 mm - 0.12"**
-  **60 g - 2.11 oz**

-  **Legno di Ulivo**
Olive wood
-  **Acciaio inox AISI 420 lucido**
Polished AISI 420 Stainless Steel
-  **Acciaio inox AISI 420 lucido**
Polished AISI 420 Stainless Steel
-  **Acciaio inox AISI 304 lucido**
Polished AISI 304 Stainless Steel
-  **Cuoio**
Leather

by Russ Kommer - LINER LOCK

FX-BR322





-  **SANDVIK 12C27**
-  **HRC 56-58**
-  **Satinata**
Satin
-  **4 mm - 0.16"**
-  **138 g - 4.86 oz**
-  **Legno di Ziricote**
Ziricote wood





-  **Acciaio inox AISI 420 lucido**
Polished AISI 420 Stainless Steel
-  **Acciaio inox AISI 420 lucido**
Polished AISI 420 Stainless Steel
-  **Acciaio inox AISI 420 lucido**
Polished AISI 420 Stainless Steel
-  **Acciaio inox AISI 304 rivestito al nichel**
Nickel plated AISI 304 Stainless Steel
-  **Cuoio**
Leather

Trendy by Moris Baroni - FRAME LOCK

461G10







-  **440C**
-  **HRC 56-58**
-  **Black idrogliider**
-  **2 mm - 0.08"**
-  **35 g - 1.23 oz**
-  **G10 nero a trama grezza**
Coarse texture Black G10





-  **Acciaio inox AISI 420 black idrogliider**
Black idrogliider AISI 420 Stainless Steel
-  **Acciaio inox AISI 420J2B Black idrogliider**
Black idrogliider AISI 420J2B Stainless Steel
-  **Acciaio inox AISI 304 sabbaiato**
Bead blasted AISI 304 Stainless Steel
-  **Cuoio**
Leather

Trendy Damasco by Moris Baroni - FRAME LOCK

463DCB







-  **Dense Twist™ pattern DS93X™, by Damasteel® (Layers: RWL34+ PMC27)**
-  **HRC 58-60**
-  **Bagno in acido cloridrico**
Etching with hydrochloric acid
-  **2 mm - 0.08"**
-  **35 g - 1.23 oz**





-  **Legno di Bocote**
Bocote wood
-  **Acciaio inox AISI 420 lucido**
Polished AISI 420 Stainless Steel
-  **Acciaio inox AISI 420J2B lucido**
Polished AISI 420J2B Stainless Steel
-  **Acciaio inox AISI 304 sabbaiato**
Bead blasted AISI 304 Stainless Steel
-  **Nylon®**

Trendy Damasco by Moris Baroni - FRAME LOCK

463DMOP









-  **Dense Twist™ pattern DS93X™, by Damasteel® (Layers: RWL34+ PMC27)**
-  **HRC 58-60**
-  **Bagno in acido cloridrico**
Etching with hydrochloric acid
-  **2 mm - 0.08"**
-  **35 g - 1.23 oz**





-  **Madreperla**
Mother of pearl
-  **Acciaio inox AISI 420 lucido**
Polished AISI 420 Stainless Steel
-  **Acciaio inox AISI 420J2B lucido**
Polished AISI 420J2B Stainless Steel
-  **Acciaio inox AISI 304 sabbaiato**
Bead blasted AISI 304 Stainless Steel
-  **Nylon®**

PHESEANT by Russ Kommer - LINER LOCK

BR-011F









-  **SANDVIK 12C27**
-  **HRC 56-58**
-  **Satinata**
Satin
-  **3 mm - 0.11"**
-  **130 g - 4.58 oz**
-  **Resina con piuma di fagiano; mostrine in acciaio inox AISI 430 lucido**
Resin with pheasant feather; polished AISI 430 Stainless Steel bolsters





-  **Acciaio inox AISI 420 lucido**
Polished AISI 420 Stainless Steel
-  **Acciaio inox AISI 420 lucido**
Polished AISI 420 Stainless Steel
-  **Acciaio inox AISI 420 lucido**
Polished AISI 420 Stainless Steel
-  **Acciaio inox AISI 304 lucido**
Polished AISI 304 Stainless Steel
-  **Cuoio**
Leather

PHESEANT by Russ Kommer - LINER LOCK

BR-011W



-  **SANDVIK 12C27**
-  **HRC 56-58**
-  **Satinata**
Satin
-  **3 mm - 0.11"**
-  **130 g - 4.58 oz**
-  **Legno di Bocote; mostrine in acciaio inox 430 lucido**
Bocote wood; polished 430 Stainless Steel bolsters

-  **Acciaio inox AISI 420 lucido**
Polished AISI 420 Stainless Steel
-  **Acciaio inox AISI 420 lucido**
Polished AISI 420 Stainless Steel
-  **Acciaio inox AISI 420 lucido**
Polished AISI 420 Stainless Steel
-  **Acciaio inox AISI 304 lucido**
Polished AISI 304 Stainless Steel
-  **Cuoio**
Leather

SKINNER - BACK LOCK

2610PW



-  SANDVIK 12C27
-  HRC 55-57
-  Satinata
Satin
-  3,5 mm - 0.14"
-  225 g - 7.93 oz

-  Legno di Pakkawood; mostrine in acciaio inox AISI 430 lucido
Pakkawood; Polished AISI 430 Stainless Steel bolsters
-  Acciaio inox AISI 420 lucido
Polished AISI 420 Stainless Steel
-  Nylon®

SKINNER - BACK LOCK

1500 OL

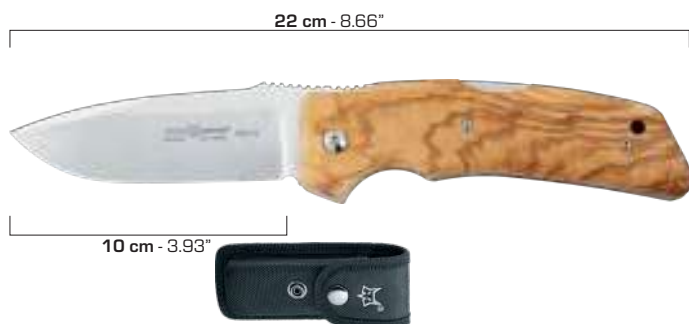







-  N690Co
-  HRC 58-60
-  Satinata
Satin
-  3,5 mm - 0.14"
-  194 g - 6.84 oz

-  Legno di Ulivo
Olive wood
-  Acciaio inox AISI 420 lucido
Polished AISI 420 Stainless Steel
-  Acciaio inox AISI 303 lucido
Polished AISI 303 Stainless Steel
-  Nylon®

THE DREAM CATCHER by Francesco Pachi - LINER LOCK

4400L



-  N690Co
-  HRC 58-60
-  Satinata
Satin
-  3 mm - 0.12"
-  104 g - 3.66 oz
-  Legno di Ulivo; mostrine in acciaio inox AISI 430
Olive wood; AISI 430 Stainless Steel bolsters

-  Acciaio inox AISI 420 lucido
Polished AISI 420 Stainless Steel
-  Alluminio T6 6082 anodizzato nero
Black anodized T6 6082 Aluminium
-  Acciaio inox AISI 304 lucido
Polished AISI 304 Stainless Steel
-  Cuoio
Leather

VOYAGER - LINER LOCK

1499

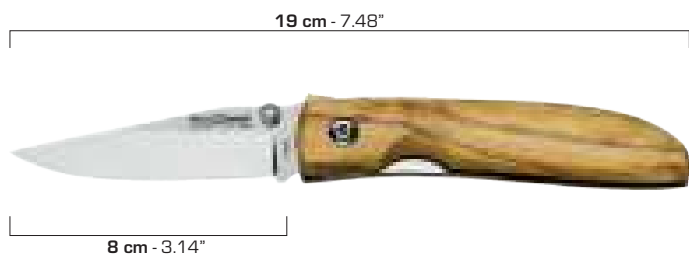

-  N690Co
-  HRC 58-60
-  Satinata
Satin
-  3 mm - 0.12"
-  85 g - 2.99 oz
-  Legno di Ulivo
Olive wood

-  Acciaio inox AISI 420 lucido
Polished AISI 420 Stainless Steel
-  Acciaio inox AISI 420 lucido
Polished AISI 420 Stainless Steel
-  Acciaio inox AISI 420 lucido
Polished AISI 420 Stainless Steel
-  Acciaio inox AISI 304 lucido
Polished AISI 304 Stainless Steel

TRADITIONAL FOLDER - SLIP JOINT

521



-  N690Co
-  HRC 58-60
-  Satinata
Satin
-  3 mm - 0.12"



-  100 g - 3.52 oz
-  Legno di Ulivo; mostrine in acciaio inox AISI 430 lucido
Olive wood; polished AISI 430 Stainless Steel
-  Acciaio inox AISI 430 lucido
Polished AISI 430 Stainless Steel

COLTELLO DA ASSAGGIO - SLIP JOINT

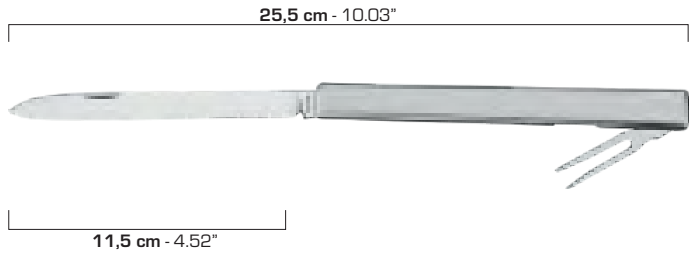
292/2



 AISI 420C
HRC 54-56
 Satinata
 Satin



 2,5 mm - 0.10"
 **60 g** - 2.11 oz
 **Acciaio inox AISI 430 lucido**
 Polished AISI 430 Stainless Steel

COLTELLO DA ASSAGGIO - SLIP JOINT

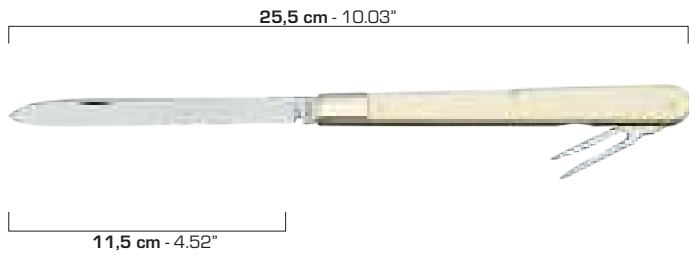
290/2



 AISI 420C
HRC 54-56
 Satinata
 Satin
 2,5 mm - 0.10"

 **50 g** - 1.76 oz
 **Imitazione di avorio, mostrina in ottone lucido**
 Ivory imitation, polished brass bolster
 **Ottone lucido**
 Polished Brass

COLTELLO DA ASSAGGIO - SLIP JOINT

292/1

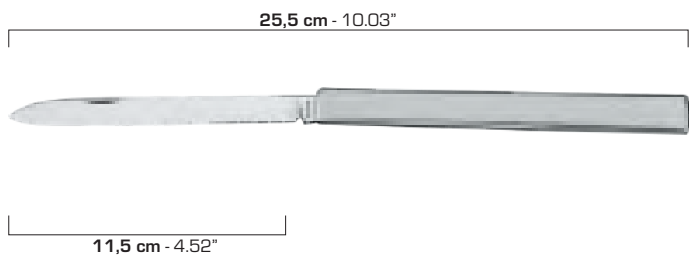

 AISI 420C
HRC 54-56
 Satinata
 Satin

 2,5 mm - 0.10"
 **55 g** - 1.94 oz
 **Acciaio inox AISI 430 lucido**
 Polished AISI 430 Stainless Steel

GENTLEMAN - SLIP JOINT

590



 AISI 440C
HRC 54-56
 Satinata
 Satin
 1,5 mm - 0.05"

 **15 g** - 0.52 oz
 **Acciaio inox AISI 430 lucido**
 Polished AISI 430 Stainless Steel
 **Acciaio inox AISI 430 lucido**
 Polished AISI 430 Stainless Steel

GENTLEMAN - SLIP JOINT

221/1

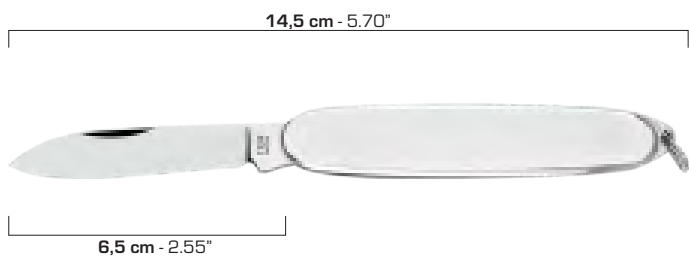



 AISI 440C
HRC 54-56
 Satinata
 Satin
 2,5 mm - 0.10"



 **35 g** - 1.23 oz
 **Acciaio inox AISI 430 lucido**
 Polished AISI 430 Stainless Steel
 **Acciaio inox AISI 430 lucido**
 Polished AISI 430 Stainless Steel

WIN COLLECTION - BACK LOCK

580



-  AISI 440A
- HRC** 57-59
-  **Satinata**
Satin
-  2,5 mm - 0.10"
-  **Kg** 55 g - 1.94 oz

-  **Legno di palissandro; mostrine in acciaio inox AISI 430 lucido**
Palissander wood; Polished AISI 430 Stainless Steel bolsters
-  **Acciaio inox AISI 420 lucido**
Polished AISI 420 Stainless Steel
-  **Ottone lucido**
Polished Brass

WIN COLLECTION - BACK LOCK

581

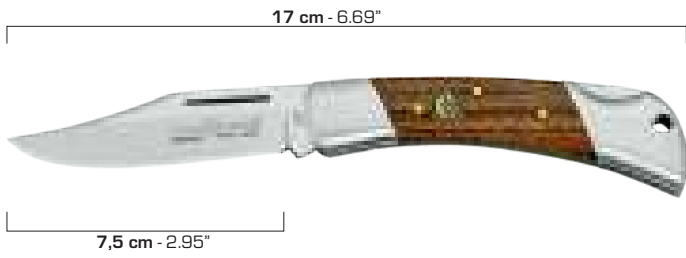

-  SANDVIK 12C27
- HRC** 55-57
-  **Satinata**
Satin
-  3 mm - 0.12"
-  **Kg** 100 g - 3.52 oz



-  **Legno di palissandro; mostrine in acciaio inox AISI 430 lucido**
Palissander wood; Polished AISI 430 Stainless Steel bolsters
-  **Acciaio inox AISI 420 lucido**
Polished AISI 420 Stainless Steel
-  **Ottone lucido**
Polished Brass

WIN COLLECTION - BACK LOCK

582



-  SANDVIK 12C27
- HRC** 55-57
-  **Satinata**
Satin
-  3 mm - 0.12"
-  **Kg** 125 g - 4.40 oz

-  **Legno di palissandro; mostrine in acciaio inox AISI 430 lucido**
Palissander wood; Polished AISI 430 Stainless Steel bolsters
-  **Acciaio inox AISI 420 lucido**
Polished AISI 420 Stainless Steel
-  **Ottone lucido**
Polished Brass

WIN COLLECTION - BACK LOCK

583



-  SANDVIK 12C27
- HRC** 55-57
-  **Satinata**
Satin
-  3 mm - 0.12"
-  **Kg** 150g - 5.29 oz

-  **Legno di palissandro; mostrine in acciaio inox AISI 430 lucido**
Palissander wood; Polished AISI 430 Stainless Steel bolsters
-  **Acciaio inox AISI 420 lucido**
Polished AISI 420 Stainless Steel
-  **Ottone lucido**
Polished Brass

WIN COLLECTION - BACK LOCK

589



-  AISI 440A
- HRC** 57-59
-  **Satinata**
Satin
-  3 mm - 0.12"
-  **Kg** 205 g - 7.23 oz



-  **Legno di palissandro; mostrine in acciaio inox AISI 430 lucido**
Palissander wood; Polished AISI 430 Stainless Steel bolsters
-  **Acciaio inox AISI 420 lucido**
Polished AISI 420 Stainless Steel
-  **Ottone lucido**
Polished Brass

WIN COLLECTION - BACK LOCK

582PW



-  AISI 440A
- HRC** 57-59
-  **Satinata**
Satin
-  3 mm - 0.12"
-  **Kg** 105 g - 3.70 oz

-  **Legno di Pakkawood**
Pakkawood
-  **Acciaio inox AISI 420 lucido**
Polished AISI 420 Stainless Steel
-  **Ottone lucido**
Polished Brass

WIN COLLECTION - BACK LOCK

551



-  AISI 440A
- HRC** 55-57
-  **Satinata**
Satin
-  3 mm - 0.12"



-  **Kg** 75 g - 2.64 oz
-  **Acciaio inox AISI 430**
AISI 430 Stainless Steel
-  **Acciaio inox AISI 420 lucido**
Polished AISI 420 Stainless Steel

HUNTING KNIFE - BACK LOCK

316



-  AISI 420C
- HRC** 54-56
-  **Satinata**
Satin
-  3 mm - 0.12"
-  **Kg** 120 g - 4.23 oz

-  **Legno di Wengé sagomato; mostrine in acciaio inox AISI 430 lucido** - Contoured Wengé wood; Polished AISI 430 Stainless Steel bolsters
-  **Acciaio inox AISI 420 lucido**
Polished AISI 420 Stainless Steel
-  **Ottone lucido**
Polished Brass

GARDENING & COUNTRY - SLIP JOINT

2C 204/19 B

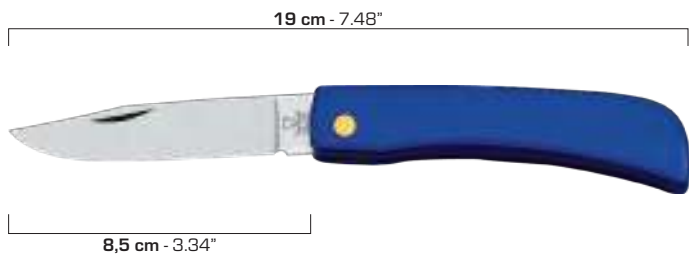

-  AISI 420C
- HRC** 54-56
-  **Satinata**
Satin
-  2,5 mm - 0.10"

-  **Kg** 70 g - 2.46 oz
-  **Nylon® blu**
Blue Nylon®
-  **Ottone lucido**
Polished Brass

GARDENING & COUNTRY - SLIP JOINT

2C 203/16

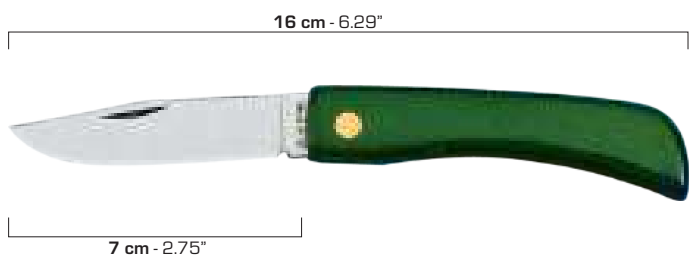

-  AISI 420C
- HRC** 54-56
-  **Satinata**
Satin
-  2 mm - 0.08"

-  **Kg** 45 g - 1.58 oz
-  **Nylon® verde**
Green Nylon®
-  **Ottone lucido**
Polished Brass

GARDENING & COUNTRY - SLIP JOINT

2C 205/20 B

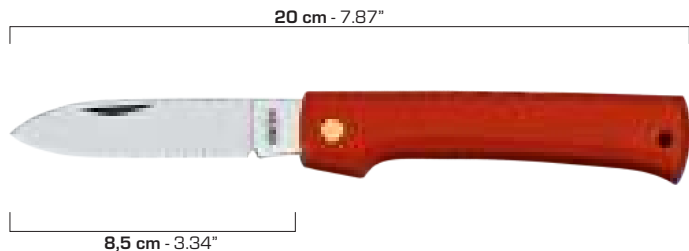

-  **AISI 420C**
- HRC 54-56**
-  **Satinata**
Satin
-  **2,5 mm - 0.10"**

-  **75 g - 2.64 oz**
-  **Nylon® rosso**
Red Nylon®
-  **Ottone lucido**
Polished Brass

GARDENING & COUNTRY - SLIP JOINT

300/18 B

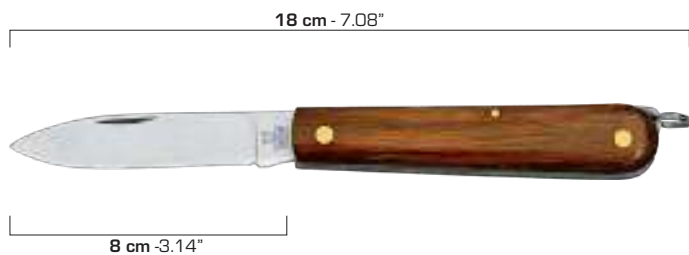

-  **AISI 420C**
- HRC 54-56**
-  **Satinata**
Satin
-  **2,5 mm - 0.10"**

-  **60 g - 2.11 oz**
-  **Legno di Palissandro**
Palisander wood
-  **Ottone lucido**
Polished Brass

GARDENING & COUNTRY - SLIP JOINT

301/16 B

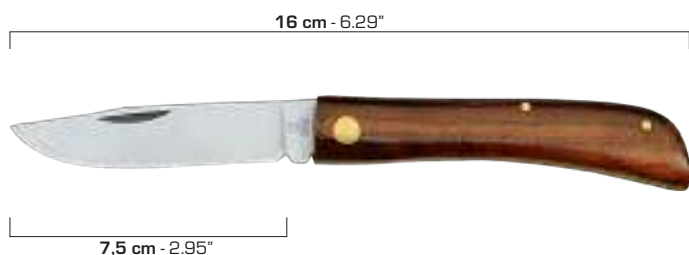

-  **AISI 420C**
- HRC 54-56**
-  **Satinata**
Satin
-  **2,5 mm - 0.10"**

-  **40 g - 1.41 oz**
-  **Legno di Palissandro**
Palisander wood
-  **Ottone lucido**
Polished Brass

GARDENING & COUNTRY - SLIP JOINT

301/18 B

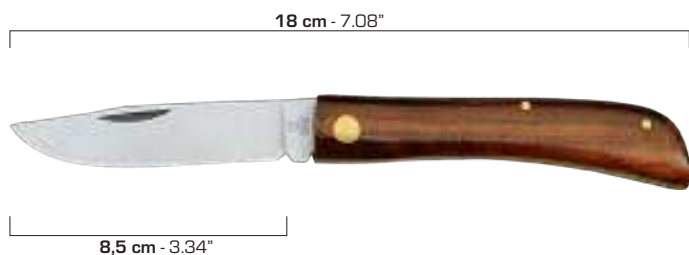

-  **AISI 420C**
- HRC 54-56**
-  **Satinata**
Satin
-  **2,5 mm - 0.10"**

-  **65 g - 2.29 oz**
-  **Legno di Palissandro**
Palisander wood
-  **Ottone lucido**
Polished Brass

GARDENING & COUNTRY - SLIP JOINT

369/13 B



-  **AISI 420C**
- HRC 54-56**
-  **Satinata**
Satin
-  **1,5 mm - 0.05"**

-  **25 g - 0.88 oz**
-  **Plastica rossa**
Red Plastic
-  **Acciaio inox AISI 303 lucido**
Polished AISI 303 Stainless Steel

GARDENING & COUNTRY - SLIP JOINT

356/16 B



-  AISI C70
-  HRC 54-56
-  Satinata
Satin
-  1,5 mm - 0.05"

-  50 g - 1.76 oz
-  Finto legno
Wood imitation
-  Acciaio inox AISI 303 lucido
Polished AISI 303 Stainless Steel

RONCOLA - SLIP JOINT

356/20

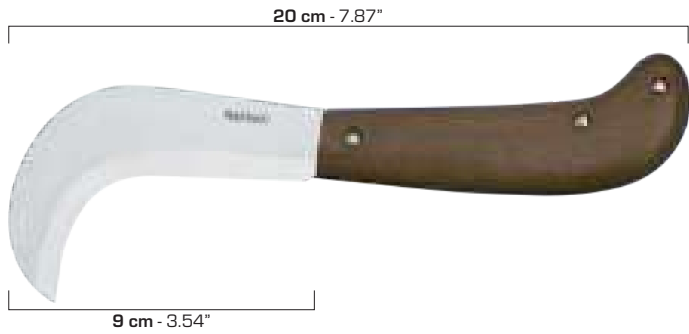

-  AISI C70
-  HRC 54-56
-  Satinata
Satin
-  2 mm - 0.08"

-  90 g - 3.17 oz
-  Finto legno
Wood imitation
-  Acciaio inox AISI 303 lucido
Polished AISI 303 Stainless Steel

RONCOLA - SLIP JOINT

369/15 B



-  AISI C70
-  HRC 54-56
-  Lucida
Polished
-  2 mm - 0.08"

-  45 g - 1.58 oz
-  Legno di Ciliegio
Cherry wood
-  Acciaio inox AISI 303 lucido
Polished AISI 303 Stainless Steel

RONCOLA - SLIP JOINT

369/17 B



-  AISI 420C
-  HRC 54-56
-  Lucida
Polished
-  2 mm - 0.08"

-  50 g - 1.76 oz
-  Legno di Ciliegio
Cherry wood
-  Acciaio inox AISI 303 lucido
Polished AISI 303 Stainless Steel

RONCOLA - SLIP JOINT

369/19 B

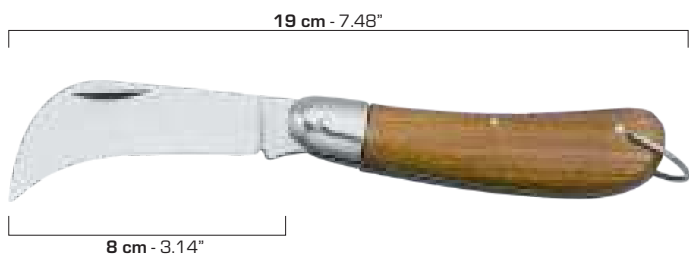

-  AISI f420C
-  HRC 54-56
-  Lucida
Polished
-  2 mm - 0.08"

-  80 g - 2.82
-  Legno di Ciliegio
Cherry wood
-  Acciaio inox AISI 303 lucido
Polished AISI 303 Stainless Steel

COLTELLO DA FUNGHI/ MUSHROOMS KNIFE - SLIP JOINT

403



-  AISI 420C
-  HRC 54-56
-  Satinata
Satin
-  3 mm - 0.12"





-  **120 g - 4.23 oz**
-  **Legno di Palissandro**
Palisander wood
-  **Acciaio inox AISI 430 lucido**
Polished AISI 430 Stainless Steel
-  **Ottone lucido**
Polished Brass

COLTELLO DA FUNGHI/ MUSHROOMS KNIFE - SLIP JOINT

404



-  AISI 420C
-  HRC 54-56
-  Satinata
Satin
-  3 mm - 0.12"



-  **120 g - 4.23 oz**
-  **Legno di Palissandro**
Palisander wood
-  **Acciaio inox AISI 430 lucido**
Polished AISI 430 Stainless Steel
-  **Ottone lucido**
Polished Brass

COLTELLO DA FUNGHI/ MUSHROOMS KNIFE - SLIP JOINT

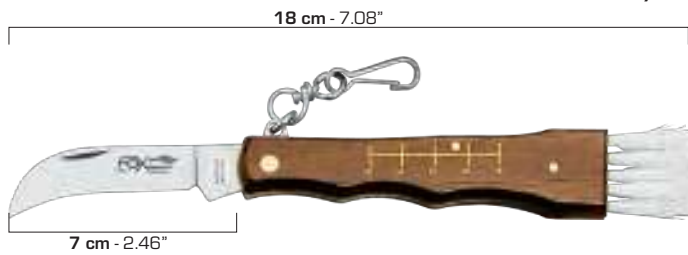
405



-  AISI 420C
-  HRC 54-56
-  Satinata
Satin
-  3 mm - 0.12"

-  **70 g - 2.46 oz**
-  **Legno di Palissandro**
Palisander wood
-  **Ottone lucido**
Polished Brass

COLTELLO DA FUNGHI/ MUSHROOMS KNIFE - SLIP JOINT

405 OL



-  AISI 420C
-  HRC 54-56
-  Satinata
Satin
-  3 mm - 0.12"



-  **70 g - 2.46 oz**
-  **Legno di Ulivo**
Olive wood
-  **Ottone lucido**
Polished Brass

COLTELLO DA FUNGHI/ MUSHROOMS KNIFE - SLIP JOINT

406



-  AISI 420C
-  HRC 54-56
-  Satinata
Satin
-  3 mm - 0.12"





-  **70 g - 2.46 oz**
-  **ABS nero/giallo/rosso**
Black/yellow/red ABS
-  **Ottone lucido**
Polished Brass

COLTELLO DA FUNGHI/ MUSHROOMS KNIFE - LINER LOCK

408



-  **AISI 440C**
- HRC** 57-59
-  **Satinata**
Satin
-  **3 mm - 0.12"**
-  **96 g - 3.38 oz**



-  **Legno di Palissandro**
Palisander wood
-  **Acciaio inox AISI 420 lucido**
Polished AISI 420 Stainless Steel
-  **Acciaio inox AISI 430 lucido**
Polished AISI 430 Stainless Steel
-  **Acciaio inox AISI 303 lucido**
Polished AISI 303 Stainless Steel
-  **Acciaio inox AISI 304 lucido**
Polished AISI 304 Stainless Steel

COLTELLO DA FUNGHI/ MUSHROOMS KNIFE - LINER LOCK

408 G10





-  **AISI 440C**
- HRC** 57-59
-  **Satinata**
Satin
-  **3 mm - 0.12"**
-  **96 g - 3.38 oz**

-  **G10 nero a tramam grezza**
Coarse texture black G10
-  **Acciaio inox AISI 420 lucido**
Polished AISI 420 Stainless Steel
-  **Acciaio inox AISI 430 lucido**
Polished AISI 430 Stainless Steel
-  **Acciaio inox AISI 303 lucido**
Polished AISI 303 Stainless Steel
-  **Acciaio inox AISI 304 lucido**
Polished AISI 304 Stainless Steel

SET DI POSATE DA CAMPEGGIO - CAMPING CUTLERY SET

676



-  **AISI 420C**
- HRC** 54-56
-  **140 g - 4.93 oz**
-  **Polipropilene PP-EP nero**
Black Polypropylene PP-PE

SET DI POSATE DA CAMPEGGIO - CAMPING CUTLERY SET

677F





-  **AISI 420C**
- HRC** 54-56
-  **155 g - 4.5.46 oz**
-  **Polipropilene PP-EP verde OD/blu/nero**
OD Green/blue/black Polypropylene PP-PE
-  **Nylon® verde OD/mimetico**
OD green/ camouflage Nylon®

MINI FOX - SLIP JOINT

CL-627/1



-  **AISI 420C**
- HRC** 54-56
-  **Satinata**
Satin
-  **1,6 mm - 0.06"**
-  **20 g - 0.70 oz**

-  **Legno di palissandro; mostrine in alpacca lucido**
Palisander wood; polished Nickel Silver bolsters
-  **Acciaio inox AISI 430 lucido**
Polished AISI 430 Stainless Steel
-  **Ottone lucido**
Polished Brass

ITALIAN TRADITIONAL "STILETTO" - AUTOMATICO/AUTAMATIC

250/20CR

20 cm - 7.87"

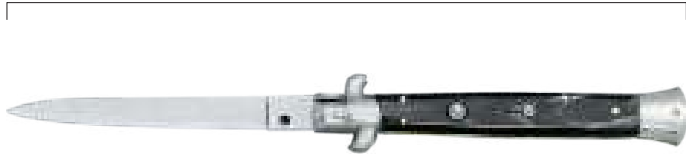

9 cm - 3.54"



AISI 420C

HRC 54-56



Satinata
Satin



3 mm - 0.12"



76 g - 2.68 oz



Corno di mucca; mostrine in acciaio
inox AISI 430 lucido
Caw horn; Polished AISI 430 Stainless
Steel bolsters



Ottone lucido
Polished Brass

ITALIAN TRADITIONAL "STILETTO" - AUTOMATICO/AUTAMATIC

250/23CR

23 cm - 9.05"

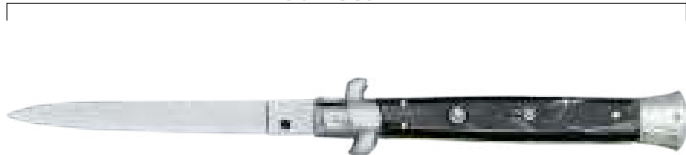

10 cm - 3.93"



AISI 420C

HRC 54-56



Satinata
Satin



3 mm - 0.12"



87 g - 3.06 oz



Corno di mucca; mostrine in acciaio
inox AISI 430 lucido
Caw horn; Polished AISI 430 Stainless
Steel bolsters



Ottone lucido
Polished Brass

ITALIAN TRADITIONAL "STILETTO" - AUTOMATICO/AUTAMATIC

250/28CR

28 cm - 11.02"

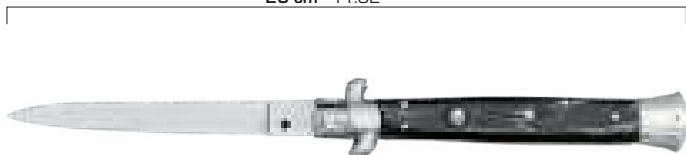

12 cm - 4.72"



AISI 420C

HRC 54-56



Satinata
Satin



3,5 mm - 0.14"



119 g - 4.19 oz



Corno di mucca; mostrine in acciaio
inox AISI 430 lucido
Caw horn; Polished AISI 430 Stainless
Steel bolsters



Ottone lucido
Polished Brass

ITALIAN TRADITIONAL "STILETTO" - AUTOMATICO/AUTAMATIC

250/33CR

33 cm - 12.99"



15 cm - 5.90"



AISI 420C

HRC 54-56



Satinata
Satin



3,5 mm - 0.14"



165 g - 5.82 oz



Corno di mucca; mostrine in acciaio
inox AISI 430 lucido
Caw horn; Polished AISI 430 Stainless
Steel bolsters



Ottone lucido
Polished Brass

ITALIAN TRADITIONAL "STILETTO" - AUTOMATICO/AUTAMATIC

250/38CR

38 cm - 14.96"



17 cm - 6.69"



AISI 420C

HRC 54-56



Satinata
Satin



5 mm - 0.20"



375 g - 13.22 oz



Corno di mucca; mostrine in acciaio
inox AISI 430 lucido
Caw horn; Polished AISI 430 Stainless
Steel bolsters





Ottone lucido
Polished Brass

ITALIAN TRADITIONAL "STILETTO" - AUTOMATICO/AUTAMATIC

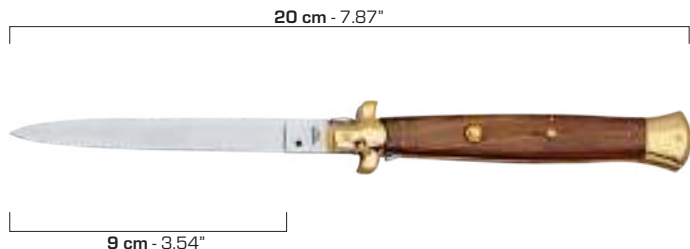
250/20PO



-  AISI 420C
-  HRC 54-56
-  Satinata
Satin
-  3 mm - 0.12"



-  **76 g - 2.68 oz**
-  **Legno di Palissandro; mostrine in ottone lucido**
Palisander wood;
Polished brass bolsters
-  **Ottone lucido**
Polished Brass

ITALIAN TRADITIONAL "STILETTO" - AUTOMATICO/AUTAMATIC

250/23PO



-  AISI 420C
-  HRC 54-56
-  Satinata
Satin
-  3 mm - 0.12"



-  **87 g - 3.06 oz**
-  **Legno di Palissandro; mostrine in ottone lucido**
Palisander wood;
Polished brass bolsters
-  **Ottone lucido**
Polished Brass

ITALIAN TRADITIONAL "STILETTO" - AUTOMATICO/AUTAMATIC

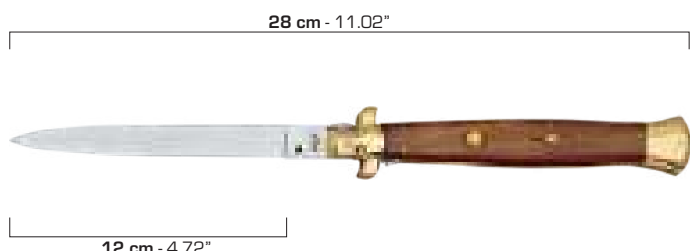
250/28PO



-  AISI 420C
-  HRC 54-56
-  Satinata
Satin
-  3,5 mm - 0.14"



-  **119 g - 4.19 oz**
-  **Legno di Palissandro; mostrine in ottone lucido**
Palisander wood;
Polished brass bolsters
-  **Ottone lucido**
Polished Brass

ITALIAN TRADITIONAL "STILETTO" - AUTOMATICO/AUTAMATIC

250/33PO







-  AISI 420C
-  HRC 54-56
-  Satinata
Satin
-  3,5 mm - 0.14"

-  **165 g - 5.82 oz**
-  **Legno di Palissandro; mostrine in ottone lucido**
Palisander wood;
Polished brass bolsters
-  **Ottone lucido**
Polished Brass

THE SMARTY FOX - AUTOMATICO / AUTAMATIC (Con blocco di sicurezza - With safety lock)

FX-503 FA



-  N690Co
-  HRC 58-60
-  Black idrogliider
-  3 mm - 0.12"
-  **140 g - 4.93 oz**

-  **G10 nero a trama grezza**
Coarse texture Black G10
-  **Acciaio inox AISI 420J2B Black idrogliider**
Black idrogliider AISI 440J2B Stainless Steel
-  **Acciaio inox AISI 420 lucido**
Polished AISI 420 Stainless Steel
-  **Acciaio inox AISI 303 lucido**
Polished AISI 303 Stainless Steel

AUTOMATICO/AUTAMATIC

257

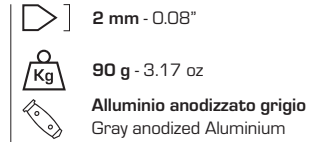
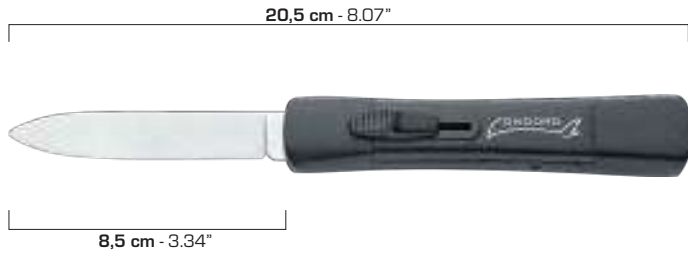

AUTOMATICO/AUTAMATIC

256

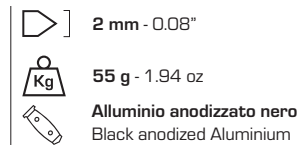
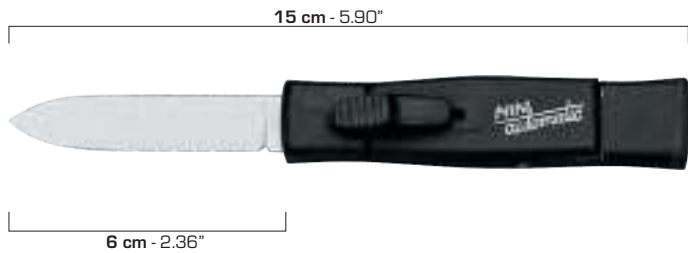

AUTOMATICO/AUTAMATIC

251

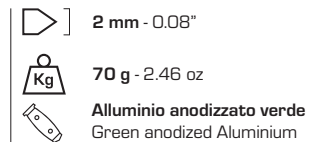

PALLOTTOLA 44 MAGNUM - SLIP JOINT

201

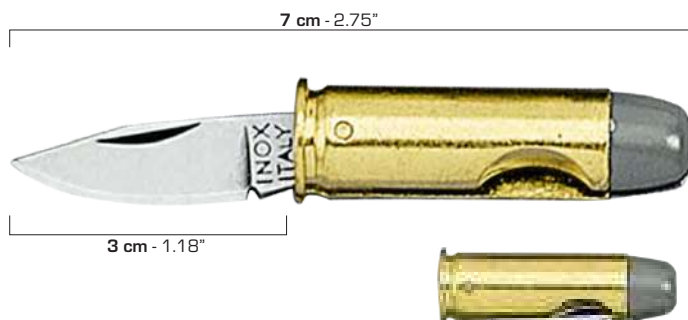

MOD CARTECCIA "GAUGE 12" - SLIP JOINT

294

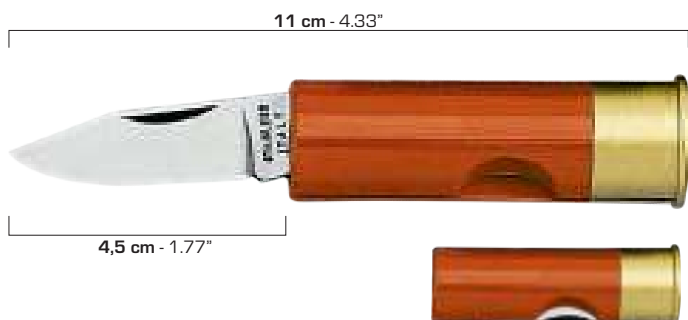











COLTELLI LAMA FISSA FOX **FOX FIXED BLADE KNIVES**

Questi coltelli sono ideati e progettati per essere sempre all'altezza dei compiti più duri. I modelli si distinguono per grande solidità, efficienza, ergonomia e linee accattivanti. L'affidabilità è garantita da pregiati materiali lavorati in Italia.

These knives are designed and engineered to always be up to the toughest tasks. The models stand out for their great solidity, efficiency, ergonomics and captivating lines. Reliability is guaranteed by precious materials machined in Italy.

NEW! **MONKEY THUMPER** by Black Roc Knives - LAMA FISSA/FIXED BLADE **FX-633**







-  Niolox
-  HRC 59-61
-  Black idrogliker stone washed
-  4 mm - 0.16"

-  165 g - 5.82 oz
-  **G10 nero lavorato in 3D**
3D machined black G10
-  **Acciaio inox AISI 303 black idrogliker**
Black idrogliker AISI 303 Stainless Steel
-  **Kydex® con belt loop**
Kydex® with belt loops

NEW! **MONKEY THUMPER** by Black Roc Knives - LAMA FISSA/FIXED BLADE **FX-633 MOD**







-  Niolox
-  HRC 59-61
-  Coarse stone washed
-  4 mm - 0.16"

-  165 g - 5.82 oz
-  **Micarta verde OD lavorata in 3D**
3D machined OD green Canvas Micarta
-  **Acciaio inox AISI 303 black idrogliker**
Black idrogliker AISI 303 Stainless Steel
-  **Kydex® con belt loop**
Kydex® with belt loops

NEW! **RYU** by Black Roc Knives - LAMA FISSA/FIXED BLADE **FX-634**







-  Niolox
-  HRC 59-61
-  Black idrogliker stone washed
-  5 mm - 0.19"

-  225 g - 7.93 oz
-  **G10 nero lavorato in 3D**
3D machined black G10
-  **Acciaio inox AISI 303 black idrogliker**
Black idrogliker AISI 303 Stainless Steel
-  **Kydex® con TEK LOK clip sostituibile con Belt Loops**
Kydex® with TEK LOK clip replaceable with Belt loops

NEW! **RYU** by Black Roc Knives - LAMA FISSA/FIXED BLADE **FX-634 MOD**







-  Niolox
-  HRC 59-61
-  Coarse stone washed
-  5 mm - 0.19"

-  225 g - 7.93 oz
-  **Micarta verde OD lavorata in 3D**
3D machined OD green Canvas Micarta
-  **Acciaio inox AISI 303 black idrogliker**
Black idrogliker AISI 303 Stainless Steel
-  **Kydex® con TEK LOK clip sostituibile con Belt Loops**
Kydex® with TEK LOK clip replaceable with Belt loops

NEW! **RYU** by Black Roc Knives - LAMA FISSA/FIXED BLADE **FX-634 DCF**



-  **HERRINGBONE DAMASCUS**
by **BALBACH DAMAST®**
(DSC® inox: N690 + Nitro-B,
120 Strati -120 Layers)
-  HRC 59-61
-  **Bagno in acido cloridrico**
Etching with hydrochloric acid
-  5 mm - 0.19"

-  207 g - 7.30 oz
-  **MARBLE CARBON FIBER**
-  **Titanio anodizzato blu**
Blue anodized titanium
-  **Cuoio con trama a fibra di carbonio**
Leather with Carbon Fiber pattern



NEW!

By Markus Reichart - LAMA FISSA/FIXED BLADE

FX-103 MB



-  **Niinox**
- HRC 59-61**
-  **5 mm - 0.19"**
-  **Sabbiata**
Bead Blasted
-  **245 g - 8.64 oz**

-  **Micarta di iuta nera, guardia in acciaio inox AISI 303 sabbiata**
Black Jute Micarta, bead blasted
AISI 303 Stainless Steel guard
-  **Acciaio inox 304 sabbiata**
Bead blasted 304 Stainless Steel
-  **Cuoio**
Leather

NEW!

PERSER By Markus Reichart - LAMA FISSA/FIXED BLADE

FX-143 MB



-  **Niinox**
- HRC 59-61**
-  **4 mm - 0.15"**
-  **Satinata**
Satin

-  **115 g - 4.06 oz**
-  **Micarta di iuta nera**
Black Jute Micarta
-  **Acciaio inox 304**
304 Stainless Steel
-  **Cuoio**
Leather

NEW!

By Markus Reichart - LAMA FISSA/FIXED BLADE

FX-140XL MB







-  **Niinox**
- HRC 59-61**
-  **5 mm - 0.19"**
-  **Satinata**
Satin

-  **370 g - 13.05 oz**
-  **Micarta di iuta nera**
Black Jute Micarta
-  **Acciaio inox 304**
304 Stainless Steel
-  **Cuoio**
Leather

NEW! COLTELLO DA IMMERSIONE GALEAZZI - GALEAZZI DIVING KNIFE - LAMA FISSA/FIXED BLADE FX-GAL-20



-  **AISI 420**
- HRC 54-56**
-  **6 mm - 0.24"**
-  **Lucido**
Polished

-  **585 g - 20.63 oz**
-  **G10 nero lavorato in 3D**
3D machined black G10
-  **Acciaio inox AISI 303 lucido**
Polished AISI 303 Stainless Steel
-  **Gomma nera**
Black rubber

FEROX by Tommaso Rumici - LAMA FISSA/FIXED BLADE

FX-630 B





-  **N690Co**
- HRC 58-60**
-  **Black idrogliider**
-  **4 mm - 0.16"**

-  **132 g - 4.65 oz**
-  **G10 nero a trama grezza**
Coarse texture black G10
-  **Acciaio inox AISI 304 rivestito al Nichel**
Nickel coated AISI 304 Stainless Steel
-  **Kydex® TEK LOK clip**
TEK LOK clip Kydex®

SHERPA - LAMA FISSA/FIXED BLADE

FX-610





-  D2
- HRC** 59-61
-  Black idrogliker stone washed
-  5 mm - 0.19"

-  **341 g - 12.02 oz**
-  **Micarta verde OD lavorata in 3D**
3D machined OD green Canvas Micarta
-  **Acciaio inox AISI 303 black idrogliker**
Black idrogliker AISI 303 Stainless Steel
-  **Cuoio**
Leather

BUSHMAN - LAMA FISSA/FIXED BLADE

FX-609 OD





-  D2
- HRC** 59-61
-  Black idrogliker stone washed
-  5 mm - 0.19"





-  **370 g - 13.05 oz**
-  **Micarta verde OD lavorata in 3D**
3D machined OD green Canvas Micarta
-  **Acciaio inox AISI 303 black idrogliker**
Black idrogliker AISI 303 Stainless Steel
-  **Cuoio (orientamento verticale o orizzontale)**
Leather (horizontal or vertical positioning)

PRO HUNTER - LAMA FISSA/FIXED BLADE

FX-131 MGT



-  N690Co
- HRC** 58-60
-  Black idrogliker
-  5 mm - 0.19"





-  **210 g - 7.40 oz**
-  **Micarta verde OD lavorata in 3D**
3D machined OD green Canvas Micarta
-  **Acciaio inox AISI 303 black idrogliker**
Black idrogliker AISI 303 Stainless Steel
-  **Cuoio**
Leather

PRO HUNTER - LAMA FISSA/FIXED BLADE

FX-132 MGT





-  N690Co
- HRC** 58-60
-  Black idrogliker
-  6 mm - 0.24"





-  **360 g - 12.70 oz**
-  **Micarta verde OD lavorata in 3D**
3D machined OD green Canvas Micarta
-  **Acciaio inox AISI 303 black idrogliker**
Black idrogliker AISI 303 Stainless Steel
-  **Nylon®**

PRO HUNTER - LAMA FISSA/FIXED BLADE

FX-133 MGT



-  N690Co
- HRC** 58-60
-  Black idrogliker
-  6 mm - 0.24"

-  **365 g - 12.87 oz**
-  **Micarta verde OD lavorata in 3D**
3D machined OD green Canvas Micarta
-  **Acciaio inox AISI 303 black idrogliker**
Black idrogliker AISI 303 Stainless Steel
-  **Nylon®**

PRO HUNTER - LAMA FISSA/FIXED BLADE

FX-131 DW





-  **N690Co**
- HRC 58-60**
-  **Satinata**
Satin
-  **5 mm - 0.19"**

-  **190 g - 6.70 oz**
-  **Legno di Santos lavorato in 3D**
3D machined Santos wood
-  **Acciaio inox AISI 303 lucido**
Polished AISI 303 Stainless Steel
-  **Cuoio**
Leather

ALASKAN HUNTER by Russ Kommer - LAMA FISSA/FIXED BLADE

FX-620 B





-  **BECUT**
- HRC 56-58**
-  **Black idroglider**
-  **4 mm - 0.16"**



-  **195 g - 6.87 oz**
-  **G10 nero sagomato**
Contoured black G10
-  **Acciaio inox AISI 304 rivestito al Nichel**
Nickel plated AISI 304 Stainless Steel
-  **Cuoio**
Leather

ALASKAN HUNTER by Russ Kommer - LAMA FISSA/FIXED BLADE

FX-621 B



-  **BECUT**
- HRC 56-58**
-  **Black idroglider**
-  **4 mm - 0.16"**



-  **190 g - 6.70 oz**
-  **G10 nero sagomato**
Contoured black G10
-  **Acciaio inox AISI 304 rivestito al Nichel**
Nickel plated AISI 304 Stainless Steel
-  **Cuoio**
Leather

CORE by Jesper Voxnæs - LAMA FISSA/FIXED BLADE

FX-605



-  **BECUT**
- HRC 56-68**
-  **Stone washed**
-  **4 mm - 0.16"**



-  **150 g - 5.29 oz**
-  **PP+TPE (polipropilene + termogomma) nero**
Black PP+TPE (Polypropylene + Thermorubber)
-  **Cuoio e Nylon***
Leather and Nylon*

CORE by Jesper Voxnæs - LAMA FISSA/FIXED BLADE



FX-605 OD





-  **BECUT**
- HRC 56-68**
-  **Stone washed**
-  **4 mm - 0.16"**

-  **150 g - 5.29 oz**
-  **PP+TPE (polipropilene + termogomma) verde OD**
OD green PP+TPE (Polypropylene + Thermorubber)
-  **Cuoio e Nylon***
Leather and Nylon*



CORE SCANDI by Jesper Voxnæs - LAMA FISSA/FIXED BLADE**FX-606**

-  **BECUT**
- HRC** 56-68
-  **Satinata**
Satin
-  **4 mm - 0.16"**

-  **150 g - 5.29 oz**
-  **PP+TPE (polipropilene + termogomma) nero**
Black PP+TPE (Polypropylene + Thermorubber)
-  **Cuoio e Nylon®**
Leather and Nylon®



CORE SCANDI by Jesper Voxnæs - LAMA FISSA/FIXED BLADE**FX-606 OD**

-  **BECUT**
- HRC** 56-68
-  **Satinata**
Satin
-  **4 mm - 0.16"**

-  **150 g - 5.29 oz**
-  **PP+TPE (polipropilene + termogomma) verde OD**
OD green PP+TPE (Polypropylene + Thermorubber)
-  **Cuoio e Nylon®**
Leather and Nylon®



CORE SKINNER by Jesper Voxnæs - LAMA FISSA/FIXED BLADE**FX-607**

-  **BECUT**
- HRC** 56-68
-  **Satinata**
Satin
-  **4 mm - 0.16"**



-  **145 g - 5.11 oz**
-  **PP+TPE (polipropilene + termogomma) nero**
Black PP+TPE (Polypropylene + Thermorubber)
-  **Cuoio e Nylon®**
Leather and Nylon®





CORE SKINNER by Jesper Voxnæs - LAMA FISSA/FIXED BLADE**FX-607 OR**

-  **BECUT**
- HRC** 56-68
-  **Satinata**
Satin
-  **4 mm - 0.16"**

-  **145 g - 5.11 oz**
-  **PP+TPE (polipropilene + termogomma) arancio**
Orange PP+TPE (Polypropylene + Thermorubber)
-  **Cuoio e Nylon®**
Leather and Nylon®

EUROPEAN HUNTER - LAMA FISSA/FIXED BLADE**1506 OL**



-  **N690Co**
- HRC** 58-60
-  **Black idrogliker**
-  **4 mm - 0.16"**

-  **130 g - 4.58 oz**
-  **Legno di Ulivo**
Olive Wood
-  **Acciaio inox AISI 304 rivestito al Nichel**
Nickel plated AISI 304 Stainless Steel
-  **Cuoio**
Leather

EUROPEAN HUNTER - LAMA FISSA/FIXED BLADE

1507 OL



-  N690Co
-  HRC 58-60
-  Black idroglider
-  4 mm - 0.16"

-  **130 g - 4.58 oz**
-  **Legno di Ulivo**
Olive Wood
-  **Acciaio inox AISI 304 rivestito al Nichel**
Nickel plated AISI 304 Stainless Steel
-  **Cuoio**
Leather

EUROPEAN HUNTER - LAMA FISSA/FIXED BLADE

1505 OL



-  N690Co
-  HRC 58-60
-  Black idroglider
-  4 mm - 0.16"





-  **185 g - 6.52 oz**
-  **Legno di Ulivo**
Olive Wood
-  **Acciaio inox AISI 304 rivestito al Nichel**
Nickel plated AISI 304 Stainless Steel
-  **Cuoio**
Leather

EUROPEAN HUNTER - LAMA FISSA/FIXED BLADE

1504 OL







-  N690Co
-  HRC 58-60
-  Black idroglider
-  4 mm - 0.16"





-  **185 g - 6.52 oz**
-  **Legno di Ulivo**
Olive Wood
-  **Acciaio inox AISI 304 rivestito al Nichel**
Nickel plated AISI 304 Stainless Steel
-  **Cuoio**
Leather

EUROPEAN HUNTER - LAMA FISSA/FIXED BLADE

1502 OL





-  N690Co
-  HRC 58-60
-  Black idroglider
-  4 mm - 0.16"





-  **185 g - 6.52 oz**
-  **Legno di Ulivo**
Olive Wood
-  **Acciaio inox AISI 304 rivestito al Nichel**
Nickel plated AISI 304 Stainless Steel
-  **Cuoio**
Leather

EUROPEAN HUNTER - LAMA FISSA/FIXED BLADE

1503 OL



-  N690Co
-  HRC 58-60
-  Black idroglider
-  4 mm - 0.16"

-  **185 g - 6.52 oz**
-  **Legno di Ulivo**
Olive Wood
-  **Acciaio inox AISI 304 rivestito al Nichel**
Nickel plated AISI 304 Stainless Steel
-  **Cuoio**
Leather





OCTOPUS VULGARIS by Tommaso Rumici - LAMA FISSA/FIXED BLADE**FX-510**

-  N690Co
- HRC** 58-60
-  Stone washed
-  4 mm - 0.16"



-  **190 g - 6.70 oz**
-  **G10 nero sagomato**
Contoured black G10
-  **Acciaio inox AISI 303 lucido**
Polished AISI 303 Stainless Steel
-  **Cuoio**
Leather





OCTOPUS VULGARIS by Tommaso Rumici - LAMA FISSA/FIXED BLADE**FX-510 OD**

-  N690Co
- HRC** 58-60
-  Stone washed
-  4 mm - 0.16"



-  **190 g - 6.70 oz**
-  **G10 verde OD sagomato**
Contoured OD green G10
-  **Acciaio inox AISI 303 lucido**
Polished AISI 303 Stainless Steel
-  **Cuoio**
Leather



OCTOPUS VULGARIS by Tommaso Rumici - LAMA FISSA/FIXED BLADE**FX-510 W**

-  **CLAD (acciaio inox AISI 410 con nucleo in inox VG10)**
CLAD (410 Stainless Steel with VG10 Stainless Steel core)
- HRC** 60-62
-  **Satinata**
Satin
-  4 mm - 0.16"



-  **170 g - 5.99 oz**
-  **Legno di Ziricote sagomato**
Contoured Ziricote wood
-  **Acciaio inox AISI 303 lucido**
Polished AISI 303 Stainless Steel
-  **Cuoio**
Leather



FAIRBAIRN SYKES FIGHTING KNIFE by Hill Knives - LAMA FISSA/FIXED BLADE**FX-592**

-  N690Co
- HRC** 58-60
-  **PVD (Physical Vapor Deposition)**
-  5 mm - 0.19"

-  **205 g - 7.23 oz**
-  **Alluminio aeronautico T6-6082 anodizzato nero, lavorato in 3D**
3D machined, Black anodized T6-6082 Aircraft Aluminium
-  **Cuoio**
Leather

FAIRBAIRN SYKES FIGHTING KNIFE by Hill Knives - LAMA FISSA/FIXED BLADE**FX-592 W**

-  N690Co
- HRC** 58-60
-  **PVD (Physical Vapor Deposition)**
-  5 mm - 0.19"

-  **180 g - 6.34 oz**
-  **Legno di Noce lavorato in 3D**
3D machined Walnut wood
-  **Cuoio**
Leather

FAIRBAIRN SYKES FIGHTING KNIFE by Hill Knives - LAMA FISSA/FIXED BLADE

FX-593



- N690Co
- HRC 58-60
- Satinata
Satin
- 5 mm - 0.19"

- 180 g - 6.34 oz**
- Legno di Noce lavorato in 3D**
3D machined Walnut wood
- Cuoio**
Leather

TANTO - LAMA FISSA/FIXED BLADE

632



- 4119 nitro-B
- HRC 55-57
- Satinata
Satin
- 5 mm - 0.19"
- 380 g - 13.40 oz**

- Micarta di tela nera sagomata, mostrine in ottone lucido**
Contoured black Canvas Micarta, Polished brass bolsters
- Ottone lucido**
Polished brass
- Cuoio**
Leather

KARAMBIT - LAMA FISSA/FIXED BLADE

FX-598



- N690Co
- HRC 58-60
- Black idrogliider
- 3 mm - 0.12"

- 95 g - 3.35 oz**
- G10 nero a trama grezza**
Coarse texture black G10
- Acciaio inox AISI 304 rivestito al Nichel**
Nickel plated AISI 304 Stainless Steel
- Kydex® con MOLLE - Lock clip**
Kydex® with MOLLE - Lock clip

MK TOOL by Doug Marcaida - LAMA FISSA/FIXED BLADE

FX-801 MK



- N690Co
- HRC 58-60
- Cerakote™ black
- 4 mm - 0.16"

- 90 g - 3.17 oz**
- Acciaio inox AISI 420J2B black idrogliider**
Black idrogliider AISI 440J2B Stainless Steel
- Acciaio inox AISI 304 rivestito al Nichel**
Nickel coated AISI 304 Stainless Steel
- Kydex® con MOLLE - Lock clip**
Kydex® with MOLLE - Lock clip

TECNOREEF by Giorgio Danese - LAMA FISSA/FIXED BLADE

468



- N690Co
- HRC 58-60
- PVD dorato e black idrogliider superficiale
Golden PVD and black idrogliider outer surface
- 4 mm - 0.16"

- 200 g - 7.05 oz**
- G10 nero a trama fine**
Fine texture black G10
- Acciaio inox AISI 303 black idrogliider**
Black idrogliider AISI 303 Stainless Steel
- Nylon® 1000 con lacci di gomma**
Nylon® 1000 with rubber straps

HUNTING KNIFE - LAMA FISSA/FIXED BLADE

604



-  **AISI 440C**
- HRC 57-59**
-  **Sabbiata**
Bead Blasted
-  **5 mm - 0.19"**

-  **325 g - 11.46 oz**
-  **Micarta di tela nera sagomata**
Contoured black Canvas Micarta
-  **Acciaio inox AISI 303 Lucido**
Polished AISI 303 Stainless Steel
-  **Cuoio**
Leather

COLTELLO DA CAMPEGGIO/CAMPING KNIFE - LAMA FISSA/FIXED BLADE

610/11



-  **AISI 420C**
- HRC 54-56**
-  **Satinata**
Satin
-  **3 mm - 0.12"**

-  **105 g - 6.34 oz**
-  **Cuoio, elsa in acciaio inox AISI 420 lucido** - Leather, Polished AISI 420 Stainless Steel pommel
-  **Cuoio**
Leather

COLTELLO DA CAMPEGGIO/CAMPING KNIFE - LAMA FISSA/FIXED BLADE

610/13



-  **AISI 420C**
- HRC 54-56**
-  **Satinata**
Satin
-  **3 mm - 0.12"**



-  **130 g - 4.58 oz**
-  **Cuoio, elsa in acciaio inox AISI 420 lucido** - Leather, Polished AISI 420 Stainless Steel pommel
-  **Cuoio**
Leather

COLTELLO DA CAMPEGGIO/CAMPING KNIFE - LAMA FISSA/FIXED BLADE

620/13



-  **SANDVIK 12C27**
- HRC 55-57**
-  **Satinata**
Satin
-  **3,5mm - 0.14"**



-  **225 g - 7.93 oz**
-  **Cuoio, elsa in acciaio inox AISI 420 lucido** - Leather, Polished AISI 420 Stainless Steel pommel
-  **Cuoio**
Leather

COLTELLO DA CAMPEGGIO/CAMPING KNIFE - LAMA FISSA/FIXED BLADE

621/13



-  **SANDVIK 12C27**
- HRC 55-57**
-  **Satinata**
Satin
-  **3,5mm - 0.14"**



-  **225 g - 7.93 oz**
-  **Cuoio, elsa in acciaio inox AISI 420 lucido** - Leather, Polished AISI 420 Stainless Steel pommel
-  **Cuoio**
Leather

EUROPEAN HUNTER - LAMA FISSA/FIXED BLADE

596PW



-  **AISI 440C**
- HRC 57-59**
-  **Satinata**
Satin
-  **3 mm - 0.12"**

-  **170 g - 5.99 oz**
-  **Pakkawood; mostrine in alpacca lucida**
Pakkawood; Polished Nickel Silver bolsters
-  **Acciaio inox AISI 303 Lucido**
Polished AISI 303 Stainless Steel
-  **Cuoio**
Leather

VINTAGE - LAMA FISSA/FIXED BLADE

596CE

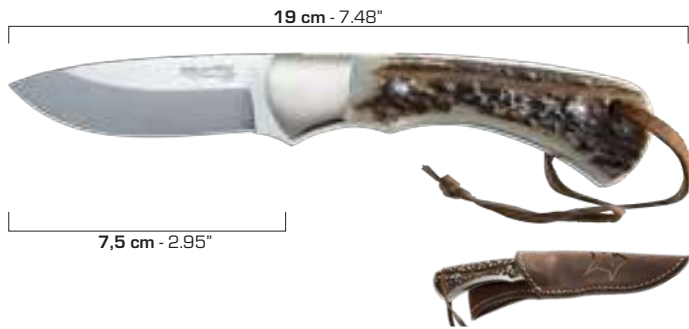

-  **AISI 440C**
- HRC 57-59**
-  **Satinata**
Satin
-  **3 mm - 0.12"**
-  **110 g - 3.88 oz**

-  **Corno di cervo; mostrine in acciaio inox AISI 430 lucido**
Stag horn; Polished AISI 430 Stainless Steel bolsters
-  **Acciaio inox AISI 303 Lucido**
Polished AISI 303 Stainless Steel
-  **Cuoio**
Leather

RETRIBUTION SCOUT by Jerry Hossom - LAMA FISSA/FIXED BLADE

FX-600 W



-  **N690Co**
- HRC 58-60**
-  **Satinata**
Satin
-  **5 mm - 0.19"**



-  **245 g - 8.64 oz**
-  **Legno di Ziricote**
Ziricote wood
-  **Acciaio inox AISI 303 lucido**
Polished AISI 303 Stainless Steel
-  **Cuoio**
Leather

SPECIAL HUNTER - LAMA FISSA/FIXED BLADE

647



-  **AISI 440B**
- HRC 56-58**
-  **Satinata**
Satin
-  **4 mm - 0.16"**
-  **270 g - 9.52 oz**

-  **Legno di palissandro; mostrine in acciaio inox AISI 430 lucido**
Palissander wood; Polished AISI 430 Stainless Steel bolsters
-  **Ottone lucido**
Polished Brass
-  **Cuoio**
Leather

SPECIAL HUNTER - LAMA FISSA/FIXED BLADE

648



-  **AISI 440B**
- HRC 56-58**
-  **Satinata**
Satin
-  **4 mm - 0.16"**

-  **270 g - 9.52 oz**
-  **Corno di cervo**
Stag horn
-  **Ottone lucido**
Polished Brass
-  **Cuoio**
Leather

SKINNER - LAMA FISSA/FIXED BLADE

2608



- N690Co
- HRC** 58-60
- Satinata**
Satin
- 4 mm - 0.16"

- 245 g - 8.64 oz**
- Pakkawood**
Pakkawood
- Acciaio inox AISI 303 Lucido**
Polished AISI 303 Stainless Steel
- Cuoio**
Leather

VINTAGE - LAMA FISSA/FIXED BLADE

638 CE



- AISI 440C
- HRC** 57-59
- Satinata**
Satin
- 3mm - 0.12"

- 70 g - 2.46 oz**
- Corno di cervo**
Stag horn
- Acciaio inox AISI 303 Lucido**
Polished AISI 303 Stainless Steel
- Cuoio**
Leather

VINTAGE - LAMA FISSA/FIXED BLADE

639 CE



- AISI 440C
- HRC** 57-59
- Satinata**
Satin
- 3 mm - 0.12"

- 100 g - 3.52oz**
- Corno di cervo**
Stag horn
- Acciaio inox AISI 303 Lucido**
Polished AISI 303 Stainless Steel
- Cuoio**
Leather

VINTAGE - LAMA FISSA/FIXED BLADE

2607 CE



- AISI 440C
- HRC** 57-59
- Satinata**
Satin
- 4 mm - 0.16"

- 130 g - 4.58 oz**
- Corno di cervo**
Stag horn
- Acciaio inox AISI 303 Lucido**
Polished AISI 303 Stainless Steel
- Cuoio**
Leather

THE PERSIAN HUNTER by Francesco Pachi - LAMA FISSA/FIXED BLADE

4450L

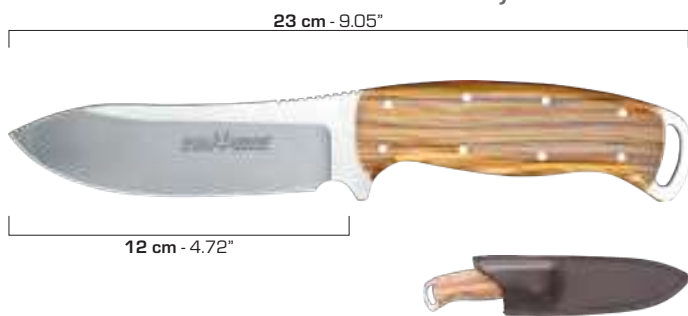

- N690Co
- HRC** 58-60
- Satinata**
Satin
- 4 mm - 0.16"

- 236 g - 8.32 oz**
- Legno di Ulivo**
Olive Wood
- Acciaio inox AISI 303 Lucido**
Polished AISI 303 Stainless Steel
- Cuoio**
Leather

LAMA FISSA/FIXED BLADE

665/13



AISI 420C

HRC 54-56

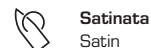

Satinata
Satin

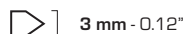

3 mm - 0.12"



120 g - 4.23 oz



Legno di palissandro
Palissander wood



Ottone lucido
Polished brass



Cuoio
Leather

FOREST - LAMA FISSA/FIXED BLADE

614



AISI 440C

HRC 57-59

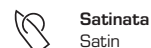

Satinata
Satin



3,5 mm - 0.14"



260 g - 9.17 oz



Micarta nera sagomata ; mostrine
in acciaio inox AISI 430 lucido
Black Canvas Micarta; Polished AISI
430 Stainless Steel bolsters



Acciaio inox AISI 303 Lucido
Polished AISI 303 Stainless Steel



Cuoio
Leather

FOREST - LAMA FISSA/FIXED BLADE

612



AISI 440C

HRC 57-59

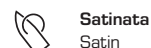

Satinata
Satin

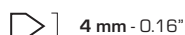

4 mm - 0.16"



270 g - 9.52 oz



Legno di Pakkawood ; mostrine
in acciaio inox AISI 430 lucido
Pakkawood; Polished AISI 430
Stainless Steel bolsters



Acciaio inox AISI 303 Lucido
Polished AISI 303 Stainless Steel



Cuoio
Leather

FOREST - LAMA FISSA/FIXED BLADE

619PW



AISI 440C

HRC 57-59

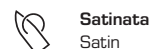

Satinata
Satin



5 mm - 0.19"



370 g - 13.05 oz



Legno di Pakkawood ; mostrine
in acciaio inox AISI 430 lucido
Pakkawood; Polished AISI 430
Stainless Steel bolsters



Acciaio inox AISI 303 Lucido
Polished AISI 303 Stainless Steel



Cuoio
Leather

BIG GAME - LAMA FISSA/FIXED BLADE

601



AISI 440C

HRC 57-59

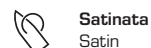

Satinata
Satin

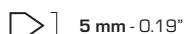

5 mm - 0.19"



315 g - 11.11 oz



Legno di Pakkawood
Pakkawood



Acciaio inox AISI 303 Lucido
Polished AISI 303 Stainless Steel



Cuoio
Leather

EXPLORER - LAMA FISSA/FIXED BLADE

697T



- AISI 440A
- HRC 55-57
- Black idrogliker
- 5 mm - 0.19"

Inclusi: Kit di sopravvivenza, bussola e pietra per affilare
Survival kit, compass and sharpening stone

- 400 g - 14.10 oz
- ABS nero, guardia in AISI 340 black idrogliker
Black ABS, black idrogliker AISI 430 guard
- Cuoio
Leather



EXPLORER - LAMA FISSA/FIXED BLADE

698



- AISI 440A
- HRC 55-57
- Satinata
Satin
- 5 mm - 0.19"

Inclusi: Kit di sopravvivenza, bussola e pietra per affilare
Survival kit, compass and sharpening stone

- 400 g - 14.10 oz
- ABS nero, guardia in AISI 340 black idrogliker
Black ABS, black idrogliker AISI 430 guard
- Cuoio
Leather



RAMBLER - LAMA FISSA/FIXED BLADE

699

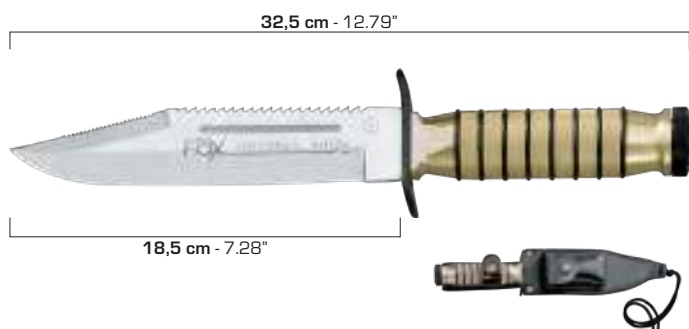

- AISI 440A
- HRC 55-57
- Satinata
Satin
- 5 mm - 0.19"

Inclusi: Kit di sopravvivenza, bussola e pietra per affilare
Survival kit, compass and sharpening stone

- 375 g - 13.22 oz
- Alluminio aeronautico T6-6082 anodizzato champagne, guardia in AISI 340 black idrogliker
Champagne anodized T6-6082 Aircraft Aluminium, black idrogliker AISI 340 guard
- Cuoio
Leather



MINI RAMBLER - LAMA FISSA/FIXED BLADE

1699 BLACK



- AISI 420C
- HRC 54-56
- Satinata
Satin
- 2,5 mm - 0.10"

- 25 g - 0.88 oz
- Alluminio aeronautico T6-6082 anodizzato nero, guardia in AISI 340 black idrogliker
Black anodized T6-6082 Aircraft Aluminium, black idrogliker AISI 340 guard
- Cuoio
Leather

MINI RAMBLER - LAMA FISSA/FIXED BLADE 1699 CHAMPAGNE



- AISI 420C
- HRC 54-56
- Satinata
Satin
- 2,5 mm - 0.10"

- 25 g - 0.88 oz
- Alluminio aeronautico T6-6082 anodizzato champagne, guardia in AISI 340 black idrogliker
Champagne anodized T6-6082 Aircraft Aluminium, black idrogliker AISI 340 guard
- Cuoio
Leather

MILITARY - LAMA FISSA/FIXED BLADE

691/18



- C70
- HRC 55-57
- Black idrogliider
- 4 mm - 0.16"

- 290 g - 10.22 oz**
- ABS nero**
Black ABS
- Cuoio**
Leather

DEFENDER - LAMA FISSA/FIXED BLADE

689

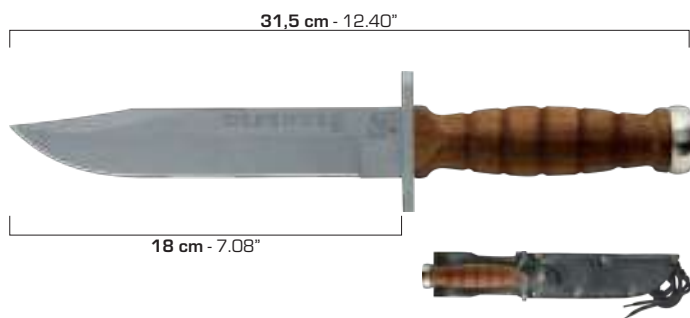

- AISI 440A
- HRC 55-57
- Sabbciata
Bead blasted
- 5 mm - 0.19"

- 335 g - 11.81 oz**
- Legno di palissandro**
Palissander wood
- Cuoio**
Leather

MILITARY - LAMA FISSA/FIXED BLADE

1684T



- AISI 440C
- HRC 57-59
- Black idrogliider
- 4 mm - 0.16"

- 225 g - 7.93 oz**
- Kraton-G nero, elsa in acciaio inox AISI 304 black idrogliider**
Black Kraton-G, black idrogliider
AISI 304 Stainless Steel guard
- Kydex® +Nylon®**

MILITARY - LAMA FISSA/FIXED BLADE

1685T



- AISI 440C
- HRC 57-59
- Black idrogliider
- 4 mm - 0.16"

- 225 g - 7.93 oz**
- Kraton-G nero, elsa in acciaio inox AISI 304 black idrogliider**
Black Kraton-G, black idrogliider
AISI 304 Stainless Steel guard
- Kydex® +Nylon®**

MILITARY - LAMA FISSA/FIXED BLADE





FX-1688TS







- AISI 440C
- HRC 57-59
- Black idrogliider
- 5 mm - 0.19"

- 270 g - 9.52 oz**
- Kraton-G nero, elsa in acciaio inox AISI 304 black idrogliider**
Black Kraton-G, black idrogliider
AISI 304 Stainless Steel guard
- Nylon®**





COMPSO by Alfredo Doricchi - LAMA FISSA/FIXED BLADE**FX-304**

-  N690Co
-  HRC 58-60
-  Black idroglider
-  3,5 mm - 0.14"

-  70 g - 2.46 oz
-  G10 nero a trama grezza
Coarse texture Black G10
-  Acciaio inox AISI 304 rivestito al Nichel
Nickel coated AISI 304 Stainless Steel
-  Kydex®



COMPSO by Alfredo Doricchi - LAMA FISSA/FIXED BLADE**FX-303 OR**

-  N690Co
-  HRC 58-60
-  Satinata
Satin
-  3,5 mm - 0.14"

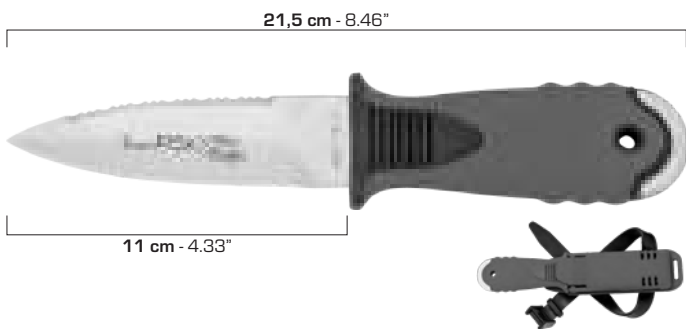

-  70 g - 2.46 oz
-  G10 arancio a trama grezza
Coarse texture Orange G10
-  Acciaio inox AISI 304 rivestito al Nichel
Nickel coated AISI 304 Stainless Steel
-  Kydex®



TEKNO SUB - LAMA FISSA/FIXED BLADE**646/11**

-  AISI 420C
-  HRC 54-56
-  Satinata
Satin
-  4 mm - 0.16"

-  145 g - 5.11 oz
-  Nylon® nero e gomma grigia
Black Nylon® and gray rubber
-  Nylon® grigio con lacci di gomma
Gray Nylon® with rubber straps



TEKNO MILITARY - LAMA FISSA/FIXED BLADE**643/11**

-  AISI 420C
-  HRC 54-56
-  Black idroglider
-  4 mm - 0.16"

-  140 g - 4.93 oz
-  Nylon® nero e gomma nera
Black Nylon® and black rubber
-  Nylon® nero con lacci di gomma
Black Nylon® with rubber straps

TEKNO MILITARY II - LAMA FISSA/FIXED BLADE**641**

-  AISI 420C
-  HRC 54-56
-  Black idroglider
-  4 mm - 0.16"

-  160 g - 5.64 oz
-  Nylon® nero e gomma nera
Black Nylon® and black rubber
-  Nylon® nero con lacci di gomma
Black Nylon® with rubber straps

OLD FOX - LAMA FISSA/FIXED BLADE

630



-  **AISI 440C**
- HRC** 57-59
-  **Satinata**
Satin
-  **5 mm - 0.19"**



-  **320 g - 11.28 oz**
-  **Legno di Bosso sagomato**
Contoured Boxwood
-  **Acciaio inox AISI 303 Lucido**
Polished AISI 303 Stainless Steel
-  **Cuoio**
Leather

AXE - LAMA FISSA/FIXED BLADE

682



-  **1.4116**
- HRC** 56-58
-  **Satinata**
Satin
-  **3,5 mm - 0.14"**



-  **440 g - 15.52 oz**
-  **Legno di Frassino naturale sagomato**
Contoured Natural Sassafras wood
-  **Cuoio**
Leather

AXE - LAMA FISSA/FIXED BLADE

682M



-  **1.4116**
- HRC** 56-58
-  **Satinata**
Satin
-  **3,5 mm - 0.14"**



-  **440 g - 15.52 oz**
-  **Legno di frassino marrone sagomato**
Contoured Brown Sassafras wood
-  **Cuoio**
Leather

AXE - LAMA FISSA/FIXED BLADE

682N



-  **1.4116**
- HRC** 56-58
-  **Satinata**
Satin
-  **3,5 mm - 0.14"**

-  **440 g - 15.52 oz**
-  **Legno di frassino nero sagomato**
Contoured Black Sassafras wood
-  **Cuoio**
Leather

MACHETE - LAMA FISSA/FIXED BLADE

686/36







-  **C70**
- HRC** 55-57
-  **Black idroglider**
-  **3,5 mm - 0.14"**



-  **675 g - 23.8 oz**
-  **Legno di Palissandro**
Palisander Wood
-  **Ottone lucido**
Polished Brass
-  **Cuoio**
Leather

KUKRI - LAMA FISSA/FIXED BLADE

658







-  4119 nitro-B
-  HRC 55-57
-  Black idrogliker
-  5 mm - 0.19"
-  630 g - 22.22 oz



-  FRN® (Nylon® rinforzato con fibra di vetro, ricoperto di gomma) nero Black FRN® (Fiberglass Reinforced Nylon® with over moulded rubber)
-  Acciaio inox AISI 304 rivestito al Nichel Nickel plated AISI 304 Stainless Steel
-  Cuoio Leather

GURKHA - LAMA FISSA/FIXED BLADE

660



-  AISI 440A
-  HRC 55-57
-  Black idrogliker
-  6,5 mm - 0.26"
-  875 g - 30.86 oz

-  FRN® (Nylon® rinforzato con fibra di vetro, ricoperto di gomma) nero Black FRN® (Fiberglass Reinforced Nylon® with over moulded rubber)
-  Acciaio inox AISI 304 rivestito al Nichel Nickel plated AISI 304 Stainless Steel
-  Cuoio Leather

JUNGLE LATIN MACHETE - LAMA FISSA/FIXED BLADE

FX-693

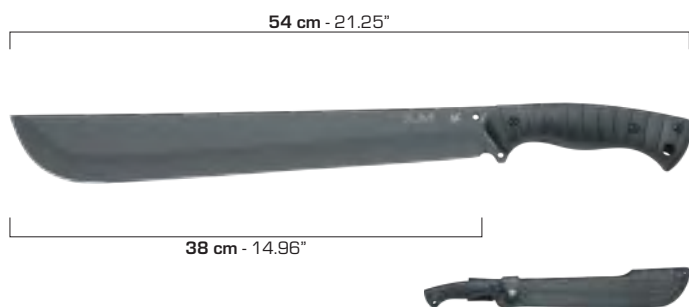

-  1.4116 Bestar
-  HRC 56-58
-  Black idrogliker
-  4 mm - 0.16"
-  675 g - 23.80 oz



-  FRN® (Nylon® rinforzato con fibra di vetro, ricoperto di gomma) nero Black FRN® (Fiberglass Reinforced Nylon® with over moulded rubber)
-  Acciaio inox AISI 304 rivestito al Nichel Nickel coated AISI 304 Stainless Steel
-  Cuoio Leather

JUNGLE PARANG MACHETE - LAMA FISSA/FIXED BLADE

FX-694



-  1.4116 Bestar
-  HRC 56-58
-  Black idrogliker
-  4 mm - 0.16"
-  425 g - 14.99 oz



-  FRN® (Nylon® rinforzato con fibra di vetro, ricoperto di gomma) nero Black FRN® (Fiberglass Reinforced Nylon® with over moulded rubber)
-  Acciaio inox AISI 304 rivestito al Nichel Nickel coated AISI 304 Stainless Steel
-  Cuoio Leather

JUNGLE BOLO MACHETE - LAMA FISSA/FIXED BLADE

FX-695



-  1.4116 Bestar
-  HRC 56-58
-  Black idrogliker
-  4 mm - 0.16"
-  515 g - 18.16 oz



-  FRN® (Nylon® rinforzato con fibra di vetro, ricoperto di gomma) nero Black FRN® (Fiberglass Reinforced Nylon® with over moulded rubber)
-  Acciaio inox AISI 304 rivestito al Nichel Nickel coated AISI 304 Stainless Steel
-  Cuoio Leather

MACHO 2 - LAMA FISSA/FIXED BLADE

680







-  1.4116 Bestar
-  HRC 56-58
-  Satinata
Satin
-  3,5 mm - 0.14"
-  515 g - 18.16 oz



-  FRN® (Nylon® rinforzato con fibra di vetro, ricoperto di gomma) nero
Black FRN® (Fiberglass Reinforced Nylon® with over moulded rubber)
-  Acciaio inox AISI 304 rivestito al Nichel
Nickel coated AISI 304 Stainless Steel
-  Cuoio
Leather

MACHO 2 - LAMA FISSA/FIXED BLADE

680 T



-  1.4116 Bestar
-  HRC 56-58
-  Black idroglider
-  3,5 mm - 0.14"
-  515 g - 18.16 oz



-  FRN® (Nylon® rinforzato con fibra di vetro, ricoperto di gomma) nero
Black FRN® (Fiberglass Reinforced Nylon® with over moulded rubber)
-  Acciaio inox AISI 304 rivestito al Nichel
Nickel coated AISI 304 Stainless Steel
-  Cuoio
Leather

MACHO - LAMA FISSA/FIXED BLADE

683



-  1.4116 Bestar
-  HRC 56-58
-  Satinata
Satin
-  3,5 mm - 0.14"
-  630 g - 22.22 oz



-  FRN® (Nylon® rinforzato con fibra di vetro, ricoperto di gomma) nero
Black FRN® (Fiberglass Reinforced Nylon® with over moulded rubber)
-  Acciaio inox AISI 304 rivestito al Nichel
Nickel coated AISI 304 Stainless Steel
-  Cuoio
Leather

PATHFINDER - LAMA FISSA/FIXED BLADE

FX-679



-  T5MOV
-  HRC 55-57
-  Satinata
Satin
-  5 mm - 0.19"
-  660 g - 23.28 oz

-  FRN® (Nylon® rinforzato con fibra di vetro, ricoperto di gomma) nero
Black FRN® (Fiberglass Reinforced Nylon® with over moulded rubber)
-  Acciaio inox AISI 304 rivestito al Nichel
Nickel coated AISI 304 Stainless Steel
-  Cuoio
Leather





TAGLIASIGARI FOX **FOX CIGAR CUTTERS**

Dedicati a chi coltiva una vera e propria passione per il mondo dei sigari, questi accessori da taglio sono eleganti e raffinati, come si addica ad un vero gentiluomo.

Dedicated to those who cultivate a real passion for the world of cigars, these cutting accessories are elegant and refined, as befits a true gentleman.



NEW!

TAGLIASIGARI FIGARO - FIGARO CIGAR CUTTER by Denis Simonutti

747 BSW

7,6 cm
2,99"



-  AISI 420C
- HRC** 54-56
-  Black idrogliker stone washed
-  2 mm - 0.07"

-  **25 g - 0.88 oz**
-  **Acciaio inox AISI 303 PVD dorato**
Golden PVD AISI 303 Stainless Steel
-  **Cuoio**
Leather

NEW!

TAGLIASIGARI FIGARO - FIGARO CIGAR CUTTER by Denis Simonutti

747 A

7,6 cm
2,99"



-  AISI 420C
- HRC** 54-56
-  **Acidato**
Acid-etched
-  2 mm - 0.07"

-  **25 g - 0.88 oz**
-  **Acciaio inox AISI 303 lucido**
Polished AISI 303 Stainless Steel
-  **Cuoio**
Leather

Il tono di grigio varia leggermente di articolo in articolo per la natura artigianale del trattamento.
The tone of gray changes between single articles due to the artisanal nature of the treatment.

TAGLIASIGARI FIGARO - FIGARO CIGAR CUTTER by Denis Simonutti

747

7,6 cm
2,99"



-  AISI 420C
- HRC** 54-56
-  **Sabbiata**
Bead blasted
-  2 mm - 0.07"



-  **25 g - 0.88 oz**
-  **Acciaio inox AISI 303 lucido**
Polished AISI 303 Stainless Steel
-  **Cuoio**
Leather





TAGLIASIGARI FIGARO - FIGARO CIGAR CUTTER by Denis Simonutti

747 D

7,6 cm
2,99"



-  **HERRINGBONE DAMASCUS**
by **BALBACH DAMAST®**
(DSC® inox: N690 + Nitro-B,
120 Strati -120 Layers)
- HRC** 54-56
-  **Bagno in acido cloridrico**
Etching with hydrochloric acid

-  2 mm - 0.07"
-  **25 g - 0.88 oz**
-  **Acciaio inox AISI 303 lucido**
Polished AISI 303 Stainless Steel
-  **Cuoio**
Leather



TAGLIASIGARI - CIGAR CUTTER

749



15 cm - 5,9"

-  AISI 440A
- HRC** 54-56
-  **Sabbiata**
Bead blasted

-  2 mm - 0.07"
-  **80 g - 2.82 oz**
-  **Acciaio inox AISI 303 rivestito al Nichel**
Nichel plated AISI 303 Stainless Steel

TAGLIASIGARI SCORREVOLE (versione mancina) - SLIDING CIGAR CUTTER (left handed version) 749 SX



 **AISI 440A**
HRC 54-56
 **Sabbiata**
 Bead blasted

 **2 mm - 0.07"**
 **80 g - 2.82 oz**
 **Acciaio inox AISI 303 rivestito al Nichel**
 Nichel plated AISI 303 Stainless Steel

TAGLIASIGARI SCORREVOLE - SLIDING CIGAR CUTTER

749 F





 **AISI 440A**
HRC 54-56
 **Sabbiata**
 Bead blasted
 **2 mm - 0.07"**



 **80 g - 2.82 oz**
 **Acciaio inox AISI 303 rivestito al Nichel**
 Nichel plated AISI 303 Stainless Steel
 **Cuoio**
 Leather

TAGLIASIGARI SCORREVOLE - SLIDING CIGAR CUTTER

749 BSW





 **AISI 440A**
HRC 54-56
 **Black idrogliker Stone washed**

 **2 mm - 0.07"**
 **80 g - 2.82 oz**
 **Acciaio inox AISI 303 rivestito al Nichel**
 Nichel plated AISI 303 Stainless Steel

TAGLIASIGARI SCORREVOLE - SLIDING CIGAR CUTTER

749 BSWF



 **AISI 440A**
HRC 54-56
 **Black idrogliker Stone washed**
 **2 mm - 0.07"**

 **80 g - 2.82 oz**
 **Acciaio inox AISI 303 rivestito al Nichel**
 Nichel plated AISI 303 Stainless Steel
 **Cuoio**
 Leather

TAGLIASIGARI SCORREVOLE - SLIDING CIGAR CUTTER

749/1



 **AISI 440A**
HRC 54-56
 **Sabbiata**
 Bead blasted

 **2 mm - 0.07"**
 **430 g - 15.16 oz**
 **Acciaio inox AISI 303 lucido**
 Polished AISI 303 Stainless Steel

Supporto in legno di Rubberwoode posacenere in inox incluso
 Rubberwood support and stainless steel ashtray included

TAGLIASIGARI - CIGAR CUTTER

748



5,5 cm
2,17"

 AISI 420J2B

HRC 54-56

 **Sabbiata**
Bead blasted

 2 mm - 0.07"

 **30 g** - 0.10 oz

 **Acciaio inox AISI 303 lucido**
Polished AISI 303 Stainless Steel

 **Cuoio**
Leather





FOX KNIVES MILITARY DIVISION

Già dal 1982, le **Coltellerie FOX** iniziano a fornire i vari reparti Italiani impegnati nelle missioni di pace in Libano.

D'allora si è continuato a rispondere alle rigorose richieste provenienti dall'Esercito, da tutti i Corpi Militari e Reparti d'Elite che necessitano di strumenti di supporto efficaci e qualificati. Grazie all'elevato standard qualitativo in Italia e all'estero, l'azienda è stata riconosciuta nell'albo dei fornitori ufficiali **NATO** con il codice **N/CAGE CODE: AG180**.

Nel 2005 è stato creato il marchio **FKMD (Fox Knives Military Division)** per distinguere la produzione tattico-militare da quella civile. L'azienda è certificata **ISO 9001** con personale altamente qualificato, macchinari a controllo numerico di ultima generazione, un alto contenuto tecnologico e una vasta scelta dei migliori materiali da impiegare durante le fasi di campionatura e di produzione.

Ogni specifica richiesta viene seguita in modo attento e rigoroso soddisfacendo qualsiasi esigenza.

Alcuni dei prodotti presenti nel catalogo sono codificati con il **NATO Stock Number (NSN)**, un codice numerico a 13 cifre che identifica l'articolo inventariato dal Ministero/dipartimento della Difesa di ogni singolo Stato.

Inoltre le **Coltellerie FOX** continuano a realizzare importanti progetti e forniture con le principali aziende operanti nel settore militare.

In 1982, **FOX Knives** began to supply to the various requests that the Italian Army had during their mission in Lebanon.

From that day on they carried on to respond to the rigorous request of the army, military and special forces that require the support of effective and qualified tools.

Thanks to the high standards of the quality in Italy and overseas, the company has been recognized as the official supplier **NATO** with **N/CAGE CODE: AG180**.

In 2005 a new brand was created **FKMD (Fox Knives Military Division)** to separate military productions from civilian productions. The company has been **ISO 9001** certified with qualified personnel, next generation CNC machinery and a vast selection of the best advanced materials to incorporate with the product. Every request is followed in an attentive and rigorous way to satisfy whatever needs.

Some of the products showed in this catalog have a **NATO Stock Number (NSN)**, a 13 digit numerical code identifying all the standardized material items of supply that can be recognized by all **NATO** countries.

Fox Knives continue to realize important projects and collaboration with the main companies that operate in the Military and Rescue market.



NATO N/CAGE CODE: AG180









COLTELLI CHIUDIBILI FKMD FKMD FOLDING KNIVES

Questi coltelli sono ideati e progettati per essere sempre all'altezza dei compiti più duri. I modelli si distinguono per grande solidità, efficienza, ergonomia e linee accattivanti. L'affidabilità è garantita da pregiati materiali lavorati in Italia.

These knives are designed and engineered to always be up to the toughest tasks. The models stand out for their great solidity, efficiency, ergonomics and captivating lines. Reliability is guaranteed by precious materials machined in Italy.



- N690Co
- HRC 58-60
- PVD (Physical Vapor Deposition)
- 4 mm - 0.16"
- 250 g - 8.82 oz
- G10 nero a trama grezza
Coarse texture black G10

- Acciaio inox AISI 420 Black idroglicer
Black idroglicer AISI 420 Stainless Steel
- Acciaio inox AISI 420J2B black idroglicer
Black idroglicer AISI 420J2B Stainless Steel
- Acciaio inox AISI 303 Black idroglicer
Black idroglicer AISI 303 Stainless Steel
- Acciaio inox AISI 303 black idroglicer
Black idroglicer AISI 303 Stainless Steel
- Nylon®

PREDATOR II - 2F FULL AUTO - AUTOMATICO/AUTOMATIC (Con blocco di sicurezza - With safety lock)

FX-448 B



- N690Co
- HRC 58-60
- Black idroglicer
- 3 mm - 0.12"
- 145 g - 5.11 oz

- FRN® (Nylon® rinforzato con fibra di vetro) nero
Black FRN® (Fiberglass Reinforced Nylon®)
- Acciaio inox AISI 420J2B black idroglicer
Black idroglicer AISI 420J2B Stainless Steel
- Polimero nero
Black polimer
- Acciaio inox AISI 304 rivestito al Nichel
Nickel plated AISI 304 Stainless Steel

PREDATOR II - 2F FULL AUTO - AUTOMATICO/AUTOMATIC (Con blocco di sicurezza - With safety lock)

FX-448 OD

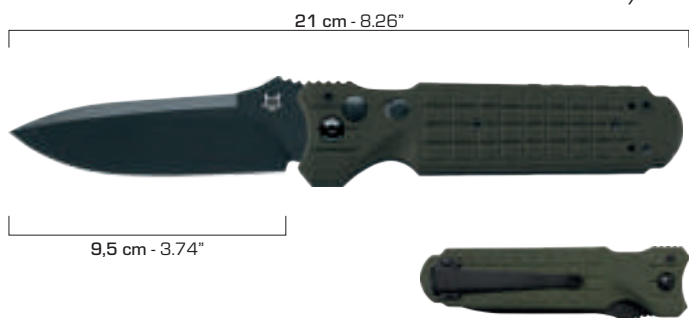

- N690Co
- HRC 58-60
- Black idroglicer
- 3 mm - 0.12"
- 145 g - 5.11 oz

- FRN® (Nylon® rinforzato con fibra di vetro) verde OD - OD green FRN® (Fiberglass Reinforced Nylon®)
- Acciaio inox AISI 420J2B black idroglicer
Black idroglicer AISI 420J2B Stainless Steel
- Polimero nero
Black polimer
- Acciaio inox AISI 304 rivestito al Nichel
Nickel plated AISI 304 Stainless Steel

PREDATOR II - 2F FULL AUTO - AUTOMATICO/AUTOMATIC (Con blocco di sicurezza - With safety lock)

FX-448 T

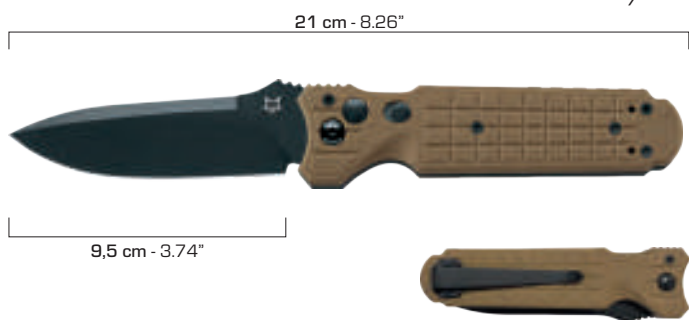

- N690Co
- HRC 58-60
- Black idroglicer
- 3 mm - 0.12"
- 145 g - 5.11 oz

- FRN® (Nylon® rinforzato con fibra di vetro) coyote tan - Coyote tan FRN® (Fiberglass Reinforced Nylon®)
- Acciaio inox AISI 420J2B black idroglicer
Black idroglicer AISI 420J2B Stainless Steel
- Polimero
Polimer
- Acciaio inox AISI 304 rivestito al Nichel
Nickel plated AISI 304 Stainless Steel

PREDATOR II - 2F LINER - LINER LOCK (Con blocco di sicurezza L.A.W.K.S. - With L.A.W.K.S.® safety lock)

FX-446 B

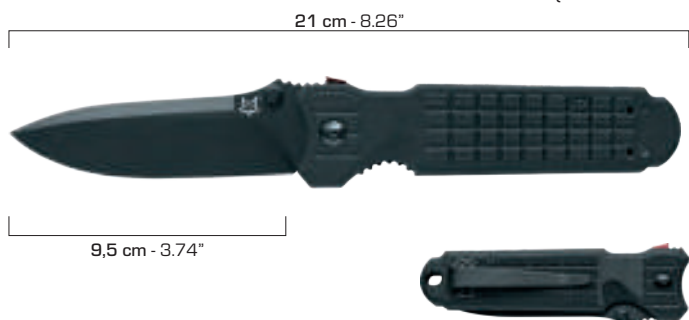

- N690Co
- HRC 58-60
- Black idroglicer
- 3 mm - 0.12"
- 145 g - 5.11 oz

- FRN® (Nylon® rinforzato con fibra di vetro) nero
Black FRN® (Fiberglass Reinforced Nylon®)
- Acciaio inox AISI 420J2B black idroglicer
Black idroglicer AISI 420J2B Stainless Steel
- Acciaio inox AISI 420 black idroglicer
Black idroglicer AISI 420 Stainless Steel
- Polimero nero
Black polimer
- Acciaio inox AISI 304 rivestito al Nichel
Nickel plated AISI 304 Stainless Steel

PREDATOR II - 2F LINER - LINER LOCK (Con blocco di sicurezza L.A.W.K.S. - With L.A.W.K.S.® safety lock)

FX-446 OD



- N690Co
- HRC** 58-60
- Black idrogliider
- 3 mm - 0.12"
- 145 g - 5.11 oz

- FRN® (Nylon® rinforzato con fibra di vetro) verde OD - OD green FRN® (Fiberglass Reinforced Nylon®)**
- Acciaio inox AISI 420J2B black idrogliider**
Black idrogliider AISI 420J2B Stainless Steel
- Acciaio inox AISI 420 black idrogliider**
Black idrogliider AISI 420 Stainless Steel
- Polimero nero**
Black polymer
- Acciaio inox AISI 304 rivestito al Nichel**
Nickel plated AISI 304 Stainless Steel

PREDATOR II - 2F LINER - LINER LOCK (Con blocco di sicurezza L.A.W.K.S. - With L.A.W.K.S.® safety lock)

FX-446 GR



- N690Co
- HRC** 58-60
- Black idrogliider
- 3 mm - 0.12"
- 145 g - 5.11 oz

- FRN® (Nylon® rinforzato con fibra di vetro) grigio**
Gray FRN® (Fiberglass Reinforced Nylon®)
- Acciaio inox AISI 420J2B black idrogliider**
Black idrogliider AISI 420J2B Stainless Steel
- Acciaio inox AISI 420 black idrogliider**
Black idrogliider AISI 420 Stainless Steel
- Polimero nero**
Black polymer
- Acciaio inox AISI 304 rivestito al Nichel**
Nickel plated AISI 304 Stainless Steel

PREDATOR II - 2F LINER - LINER LOCK (Con blocco di sicurezza L.A.W.K.S. - With L.A.W.K.S.® safety lock)

FX-446 BS



- N690Co
- HRC** 58-60
- Black idrogliider
- 3 mm - 0.12"
- 145 g - 5.11 oz

- FRN® (Nylon® rinforzato con fibra di vetro) nero**
Black FRN® (Fiberglass Reinforced Nylon®)
- Acciaio inox AISI 420J2B black idrogliider**
Black idrogliider AISI 420J2B Stainless Steel
- Acciaio inox AISI 420 black idrogliider**
Black idrogliider AISI 420 Stainless Steel
- Polimero nero**
Black polymer
- Acciaio inox AISI 304 rivestito al Nichel**
Nickel plated AISI 304 Stainless Steel

PREDATOR II - 2F LINER - LINER LOCK (Con blocco di sicurezza L.A.W.K.S. - With L.A.W.K.S.® safety lock)

FX-446 ODS



- N690Co
- HRC** 58-60
- Black idrogliider
- 3 mm - 0.12"
- 145 g - 5.11 oz

- FRN® (Nylon® rinforzato con fibra di vetro) verde OD - OD green FRN® (Fiberglass Reinforced Nylon®)**
- Acciaio inox AISI 420J2B black idrogliider**
Black idrogliider AISI 420J2B Stainless Steel
- Acciaio inox AISI 420 black idrogliider**
Black idrogliider AISI 420 Stainless Steel
- Polimero nero**
Black polymer
- Acciaio inox AISI 304 rivestito al Nichel**
Nickel plated AISI 304 Stainless Steel

PREDATOR II - 2F LINER - LINER LOCK (Con blocco di sicurezza L.A.W.K.S. - With L.A.W.K.S.® safety lock)

FX-446 GRS



- N690Co
- HRC** 58-60
- Black idrogliider
- 3 mm - 0.12"
- 145 g - 5.11 oz

- FRN® (Nylon® rinforzato con fibra di vetro) grigio - Gray FRN® (Fiberglass Reinforced Nylon®)**
- Acciaio inox AISI 420J2B black idrogliider**
Black idrogliider AISI 420J2B Stainless Steel
- Acciaio inox AISI 420 black idrogliider**
Black idrogliider AISI 420 Stainless Steel
- Polimero nero**
Black polymer
- Acciaio inox AISI 304 rivestito al Nichel**
Nickel plated AISI 304 Stainless Steel

FOX BANTAY by Borut Kincl - LINER LOCK (Con blocco di sicurezza LA.W.K.S. - With LA.W.K.S.® safety lock)

SLO-01 S

22,5 cm - 8.85"



9,5 cm - 3.74"

- N690Co**
- HRC 58-60**
- PVD (Physical Vapor Deposition)**
- 3,5 mm - 0.14"**
- 130 g - 4.58 oz**
- G10 nero a trama grezza**
Coarse texture black G10

- Acciaio inox AISI 420 black idroglicer**
Black idroglicer AISI 420 Stainless Steel
- Acciaio inox AISI 420J2B black idroglicer**
Black idroglicer AISI 420J2B Stainless Steel
- Tungsteno**
Tungsten
- Acciaio inox AISI 303 black idroglicer**
Black idroglicer AISI 303 Stainless Steel
- Acciaio inox AISI 303 Black idroglicer**
Black idroglicer AISI 303 Stainless Steel
- Nylon®**

HECTOR - FRAME LOCK

FX-504 B

20,2 cm - 7.95"

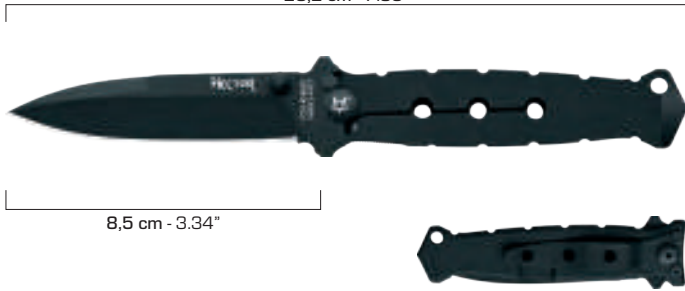

8,5 cm - 3.34"

- N690Co**
- HRC 58-60**
- Black idroglicer**
- 3 mm - 0.12"**
- 80 g - 2.82 oz**
- Acciaio inox 420J2B black idroglicer**
Black idroglicer 420J2B stainless steel

- Acciaio inox 420J2B black idroglicer**
Black idroglicer 420J2B stainless steel
- Acciaio inox AISI 420J2B black idroglicer**
Black idroglicer AISI 420J2B Stainless Steel
- Acciaio inox AISI 420 black idroglicer**
Black idroglicer AISI 420 Stainless Steel
- Acciaio inox AISI 303 Black idroglicer**
Black idroglicer AISI 303 Stainless Steel

by Patrick Nihiser - LINER LOCK

FX-MTF5

22 cm - 8.66"



9 cm - 3.54"

- N690Co**
- HRC 58-60**
- PVD (Physical Vapor Deposition)**
- 3 mm - 0.12"**
- 205 g - 7.23 oz**
- G10 nero sagomato**
Contoured black G10

- Acciaio inox AISI 420 black idroglicer**
Black idroglicer AISI 420 Stainless Steel
- Acciaio inox AISI 420J2B black idroglicer**
Black idroglicer AISI 420J2B Stainless Steel
- Acciaio inox AISI 420 black idroglicer**
Black idroglicer AISI 420 Stainless Steel
- Titanio sabbiato**
Bead blasted Titanium
- Acciaio inox AISI 304 rivestito al Nichel**
Nickel plated AISI 304 Stainless Steel

FX-117 N.E.R.O. NIGHTHAWK TACTICAL FOLDERS - LINER LOCK (Con blocco di sicurezza LA.W.K.S. - With LA.W.K.S.® safety lock) **FX-117 CT**

21 cm - 8.26"



9,5 cm - 3.74"

- Titanium grade 5 + N690Co**
- HRC 58-60**
- PVD (Physical Vapor Deposition)**
- 5 mm - 0.20"**
- 185 g - 6.52 oz**
- G10 nero a trama grezza**
Coarse texture black G10

- Acciaio inox AISI 420 black idroglicer**
Black idroglicer AISI 420 Stainless Steel
- Acciaio inox AISI 420J2B black idroglicer**
Black idroglicer AISI 420J2B Stainless Steel
- Acciaio inox AISI 420 black idroglicer**
Black idroglicer AISI 420 Stainless Steel
- Alluminio T6 6082 anodizzato nero**
Black anodized Aluminum T6 6082
- Acciaio inox AISI 304 rivestito al Nichel**
Nickel plated AISI 304 Stainless Steel

FX-117 N.E.R.O. NIGHTHAWK TACTICAL FOLDERS - LINER LOCK (Con blocco di sicurezza LA.W.K.S. - With LA.W.K.S.® safety lock) **FX-117 T**

21 cm - 8.26"



9,5 cm - 3.74"

- N690Co**
- HRC 58-60**
- Black idroglicer**
- 5 mm - 0.20"**
- 200 g - 7.05 oz**
- G10 nero a trama grezza**
Coarse texture black G10

- Acciaio inox AISI 420 black idroglicer**
Black idroglicer AISI 420 Stainless Steel
- Acciaio inox AISI 420J2B black idroglicer**
Black idroglicer AISI 420J2B Stainless Steel
- Acciaio inox AISI 420 black idroglicer**
Black idroglicer AISI 420 Stainless Steel
- Alluminio T6 6082 anodizzato nero**
Black anodized Aluminum T6 6082
- Acciaio inox AISI 304 rivestito al Nichel**
Nickel plated AISI 304 Stainless Steel

ARURU - BACK LOCK (Con blocco di sicurezza - With safety lock)

FX-506GR



- N690Co
- HRC 58-60
- Sabbziata
Bead blasted
- 5 mm - 0.20"
- 300 g - 10.58 oz

- G10 grigio sagomato
Contoured gray G10
- Acciaio inox AISI 420 sabbciato
Bead blasted AISI 420 stainless steel
- Acciaio inox AISI 420 lucido
Polished AISI 420 Stainless Steel
- Acciaio inox AISI 304 rivestito al Nichel
Nickel plated AISI 304 Stainless Steel
- Nylon® 1000D con sistema MOLLE
Nylon® 1000D with MOLLE system

ANUNNAKI - BACK LOCK (Con blocco di sicurezza - With safety lock)

FX-505GR

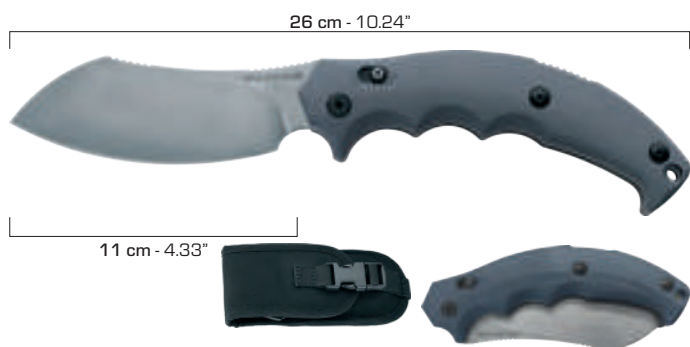

- N690Co
- HRC 58-60
- Sabbziata
Bead blasted
- 5 mm - 0.20"
- 310 g - 10.93 oz

- G10 grigio sagomato
Contoured gray G10
- Acciaio inox AISI 420 sabbciato
Bead blasted AISI 420 stainless steel
- Acciaio inox AISI 420 lucido
Polished AISI 420 Stainless Steel
- Acciaio inox AISI 304 rivestito al Nichel
Nickel plated AISI 304 Stainless Steel
- Nylon® 1000D con sistema MOLLE
Nylon® 1000D with MOLLE system

ANUNNAKI - BACK LOCK (Con blocco di sicurezza - With safety lock)

FX-505



- N690Co
- HRC 58-60
- Cerakote™ black
- 5 mm - 0.20"
- 310 g - 10.93 oz

- G10 nero sagomato
Contoured black G10
- Acciaio inox AISI 420 black idroglicer
Black idroglicer AISI 420 Stainless Steel
- Acciaio inox AISI 420 black idroglicer
Black idroglicer AISI 420 Stainless Steel
- Acciaio inox AISI 303 black idroglicer
Black idroglicer AISI 303 Stainless Steel
- Nylon® 1000D con sistema MOLLE
Nylon® 1000D with MOLLE system

TRACKER FOLDING KNIFE "MESKWAKI" - BACK LOCK (Con blocco di sicurezza - With safety lock)

FX-500



- N690Co
- HRC 58-60
- Sabbziata
Bead blasted
- 5 mm - 0.20"
- 445 g - 15.69 oz

- Micarta verde
Green canvas Micarta
- Acciaio inox AISI 420 sabbciato
Bead blasted AISI 420 stainless steel
- Acciaio inox AISI 303 black idroglicer
Black idroglicer AISI 303 Stainless Steel
- Nylon® 1000D con sistema MOLLE. Consente il trasporto del coltello anche da aperto
Nylon® 1000D with MOLLE system. Enables the knife to be also carried as fixed blade

TRACKER FOLDING KNIFE "MESKWAKI" - BACK LOCK (Con blocco di sicurezza - With safety lock)

FX-501



- N690Co
- HRC 58-60
- PVD (Physical Vapor Deposition)
- 5 mm - 0.20"
- 445 g - 15.69 oz

- G10 terra a trama grezza
Coarse texture earth green G10
- Acciaio inox AISI 420 sabbciato
Bead blasted AISI 420 stainless steel
- Acciaio inox AISI 303 black idroglicer
Black idroglicer AISI 303 Stainless Steel
- Nylon® 1000D con sistema MOLLE. Consente il trasporto del coltello anche da aperto
Nylon® 1000D with MOLLE system. Enables the knife to be also carried as fixed blade

A.L.S.R. 49° CAPRICORNO - LINER LOCK

FX-ALSR 49



- N690Co
- HRC 58-60
- Black idrogliker
- 3 mm - 0.12"
- 140 g - 4.93 oz
- FRN® (Nylon® rinforzato con fibra di vetro) nero
Black FRN® (Fiberglass Reinforced Nylon®)

- Acciaio inox AISI 420 black idrogliker
Black idrogliker AISI 420 Stainless Steel
- Acciaio inox AISI 420J2B black idrogliker
Black idrogliker AISI 420J2B Stainless Steel
- N690Co black idrogliker
- Acciaio inox AISI 420 lucido
Polished AISI 420 stainless steel
- Acciaio inox AISI 304 rivestito al Nichel
Nickel plated AISI 304 Stainless Steel
- Nylon® 1000D con sistema MOLLE
Nylon® 1000D with MOLLE system

A.L.S.R. 2 AIR LAND & SEA RESCUE - LINER LOCK (Con blocco di sicurezza L.A.W.K.S. - With L.A.W.K.S.® safety lock)

FX-447 C



- N690Co
- HRC 58-60
- Satinata
Satin
- 3 mm - 0.12"
- 140 g - 4.93 oz
- FRN® (Nylon® rinforzato con fibra di vetro, ricoperto di gomma) rosso e giallo
Red and yellow FRN® (Fiberglass Reinforced Nylon® with over moulded rubber)

- Acciaio inox AISI 420 lucido
Polished AISI 420 stainless steel
- Acciaio inox AISI 420J2B black idrogliker
Black idrogliker AISI 420J2B Stainless Steel
- N690Co lucido
- Acciaio inox AISI 420 lucido
Polished AISI 420 stainless steel
- Acciaio inox AISI 304 rivestito al Nichel
Nickel plated AISI 304 Stainless Steel
- Nylon® 1000D con sistema MOLLE
Nylon® 1000D with MOLLE system

A.L.S.R. 2 AIR LAND & SEA RESCUE - LINER LOCK

FX-447 COD



- N690Co
- HRC 58-60
- Black idrogliker
- 3 mm - 0.12"
- 140 g - 4.93 oz
- FRN® (Nylon® rinforzato con fibra di vetro) verde OD - OD green FRN® (Fiberglass Reinforced Nylon®)

- Acciaio inox AISI 420 black idrogliker
Black idrogliker AISI 420 Stainless Steel
- Acciaio inox AISI 420J2B black idrogliker
Black idrogliker AISI 420J2B Stainless Steel
- N690Co black idrogliker
- Acciaio inox AISI 420 lucido
Polished AISI 420 stainless steel
- Acciaio inox AISI 304 rivestito al Nichel
Nickel plated AISI 304 Stainless Steel
- Nylon® 1000D con sistema MOLLE
Nylon® 1000D with MOLLE system

A.L.S.R. 2 AIR LAND & SEA RESCUE - LINER LOCK (Con blocco di sicurezza L.A.W.K.S. - With L.A.W.K.S.® safety lock)

FX-447 CB



- N690Co
- HRC 58-60
- Black idrogliker
- 3 mm - 0.12"
- 140 g - 4.93 oz
- FRN® (Nylon® rinforzato con fibra di vetro) nero
Black FRN® (Fiberglass Reinforced Nylon®)

- Acciaio inox AISI 420 black idrogliker
Black idrogliker AISI 420 Stainless Steel
- Acciaio inox AISI 420J2B black idrogliker
Black idrogliker AISI 420J2B Stainless Steel
- N690Co black idrogliker
- Acciaio inox AISI 420 lucido
Polished AISI 420 stainless steel
- Acciaio inox AISI 304 rivestito al Nichel
Nickel plated AISI 304 Stainless Steel
- Nylon® 1000D con sistema MOLLE
Nylon® 1000D with MOLLE system

A.L.S.R. 2 AIR LAND & SEA RESCUE - LINER LOCK

FX-447 SFB



- N690Co
- HRC 58-60
- Black idrogliker
- 3 mm - 0.12"
- 140 g - 4.93 oz
- FRN® (Nylon® rinforzato con fibra di vetro) nero - Black FRN® (Fiberglass Reinforced Nylon® with over moulded rubber)

- Acciaio inox AISI 420 black idrogliker
Black idrogliker AISI 420 Stainless Steel
- Acciaio inox AISI 420J2B black idrogliker
Black idrogliker AISI 420J2B Stainless Steel
- N690Co black idrogliker
- Acciaio inox AISI 420 lucido
Polished AISI 420 stainless steel
- Acciaio inox AISI 304 rivestito al Nichel
Nickel plated AISI 304 Stainless Steel
- Nylon® 1000D con sistema MOLLE
Nylon® 1000D with MOLLE system

E.R.T. RESCUE KNIFE - LINER LOCK

FX-211



- N690Co
- HRC 58-60
- Sabbata
Bead blasted
- 5 mm - 0.20"
- 175 g - 6.17 oz
- FRN® (Nylon® rinforzato con fibra di vetro) arancione - Orange FRN® (Fiberglass Reinforced Nylon®)
- Acciaio inox AISI 420 lucido
Polished AISI 420 stainless steel

- Acciaio inox AISI 420J2B black idrogliider
Black idrogliider AISI 440J2B Stainless Steel
- Tungsteno
Tungsten
- Acciaio inox AISI 420 sabbata
Bead blasted AISI 420 Stainless Steel
- ABS arancione
Orange ABS
- Acciaio inox AISI 303 black idrogliider
Black idrogliider AISI 303 Stainless Steel
- FRN® (Nylon® rinforzato con fibra di vetro) nero, con MOLLE - lock clip e TEK LOK clip
Black FRN® (Fiberglass Reinforced Nylon®), with MOLLE - lock clip and TEK LOK clip

E.R.T. RESCUE KNIFE - LINER LOCK

FX-212



- N690Co
- HRC 58-60
- Black idrogliider
- 5 mm - 0.20"
- 175 g - 6.17 oz
- FRN® (Nylon® rinforzato con fibra di vetro) nero
Black FRN® (Fiberglass Reinforced Nylon®)
- Acciaio inox AISI 420 black idrogliider
Black idrogliider AISI 420 Stainless Steel

- Acciaio inox AISI 420J2B black idrogliider
Black idrogliider AISI 440J2B Stainless Steel
- Tungsteno
Tungsten
- Acciaio inox AISI 420 black idrogliider
Black idrogliider AISI 420 Stainless Steel
- ABS nero
Black ABS
- Acciaio inox AISI 303 black idrogliider
Black idrogliider AISI 303 Stainless Steel
- FRN® (Nylon® rinforzato con fibra di vetro) nero, con MOLLE - lock clip e TEK LOK clip
Black FRN® (Fiberglass Reinforced Nylon®), with MOLLE - lock clip and TEK LOK clip

E.R.T. RESCUE KNIFE - LINER LOCK

FX-213SS

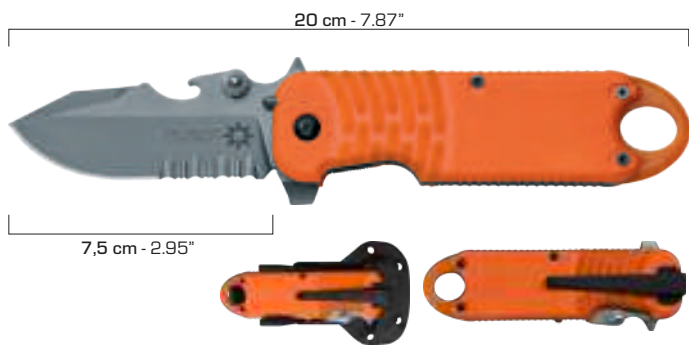

- N690Co
- HRC 58-60
- Sabbata
Bead blasted
- 5 mm - 0.20"
- 175 g - 6.17 oz
- FRN® (Nylon® rinforzato con fibra di vetro) arancione - Orange FRN® (Fiberglass Reinforced Nylon®)
- Acciaio inox AISI 420 lucido
Polished AISI 420 stainless steel

- Acciaio inox AISI 420J2B black idrogliider
Black idrogliider AISI 440J2B Stainless Steel
- Tungsteno
Tungsten
- Acciaio inox AISI 420 sabbata
Bead blasted AISI 420 Stainless Steel
- ABS arancione
Orange ABS
- Acciaio inox AISI 303 black idrogliider
Black idrogliider AISI 303 Stainless Steel
- FRN® (Nylon® rinforzato con fibra di vetro) nero, con MOLLE - lock clip e TEK LOK clip
Black FRN® (Fiberglass Reinforced Nylon®), with MOLLE - lock clip and TEK LOK clip

E.R.T. RESCUE KNIFE - LINER LOCK

FX-213TS

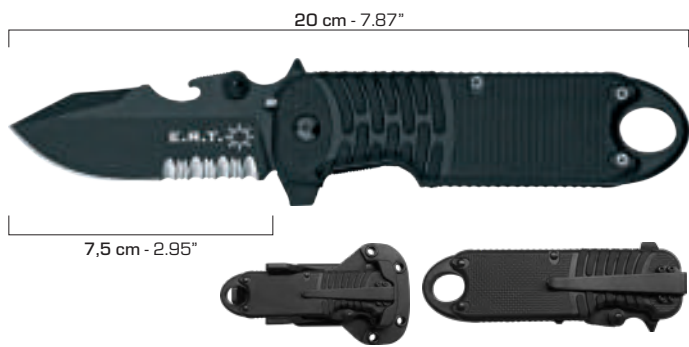

- N690Co
- HRC 58-60
- Black idrogliider
- 5 mm - 0.20"
- 175 g - 6.17 oz
- FRN® (Nylon® rinforzato con fibra di vetro) nero
Black FRN® (Fiberglass Reinforced Nylon®)
- Acciaio inox AISI 420 black idrogliider
Black idrogliider AISI 420 Stainless Steel

- Acciaio inox AISI 420J2B black idrogliider
Black idrogliider AISI 440J2B Stainless Steel
- Tungsteno
Tungsten
- Acciaio inox AISI 420 black idrogliider
Black idrogliider AISI 420 Stainless Steel
- ABS nero
Black ABS
- Acciaio inox AISI 303 black idrogliider
Black idrogliider AISI 303 Stainless Steel
- FRN® (Nylon® rinforzato con fibra di vetro) nero, con MOLLE - lock clip e TEK LOK clip
Black FRN® (Fiberglass Reinforced Nylon®), with MOLLE - lock clip and TEK LOK clip

E.R.T. RESCUE KNIFE - LINER LOCK

FX-214

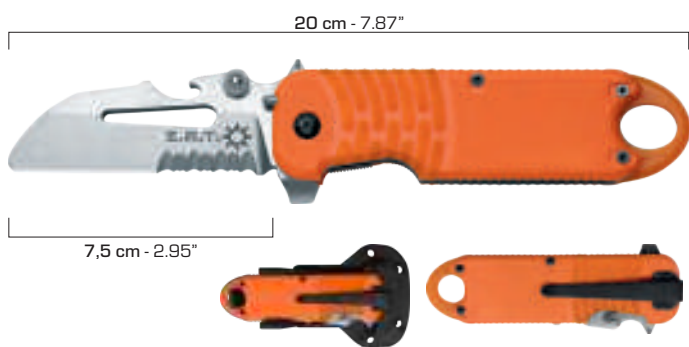

- N690Co
- HRC 58-60
- Stone wash
- 5 mm - 0.20"
- 175 g - 6.17 oz
- FRN® (Nylon® rinforzato con fibra di vetro) arancione - Orange FRN® (Fiberglass Reinforced Nylon®)
- Acciaio inox AISI 420 lucido
Polished AISI 420 stainless steel

- Acciaio inox AISI 420J2B black idrogliider
Black idrogliider AISI 440J2B Stainless Steel
- Tungsteno
Tungsten
- Acciaio inox AISI 420 lucido
polished AISI 420 Stainless Steel
- ABS arancione
Orange ABS
- Acciaio inox AISI 303 black idrogliider
Black idrogliider AISI 303 Stainless Steel
- FRN® (Nylon® rinforzato con fibra di vetro) nero, con MOLLE - lock clip e TEK LOK clip
Black FRN® (Fiberglass Reinforced Nylon®), with MOLLE - lock clip and TEK LOK clip

HAVOC by Mike Vellekamp - FRAME LOCK

FKU-HV02TIB



- N690Co**
- HRC 58-60**
- Cerakote™ black**
- 4 mm - 0.16"**
- 135 g - 4.76 oz**
- G10 nero sagomato**
Contoured black G10

- Titanio sabbato**
Bead basted Titanium
- Acciaio inox AISI 420J2B black idroglicer**
Black idroglicer AISI 420J2B Stainless Steel
- Acciaio inox AISI 420 PVD**
PVD AISI 420 Stainless Steel
- Acciaio inox AISI 303 lucido**
Polished AISI 303 Stainless Steel
- Acciaio inox AISI 303 black idroglicer**
Black idroglicer AISI 303 Stainless Steel

HAVOC by Mike Vellekamp - FRAME LOCK

FKU-HV02TTIB



- N690Co**
- HRC 58-60**
- Cerakote™ black**
- 4 mm - 0.16"**
- 135 g - 4.76 oz**
- G10 nero sagomato**
Contoured black G10

- Titanio sabbato**
Bead basted Titanium
- Acciaio inox AISI 420J2B black idroglicer**
Black idroglicer AISI 420J2B Stainless Steel
- Acciaio inox AISI 420 PVD**
PVD AISI 420 Stainless Steel
- Acciaio inox AISI 303 lucido**
Polished AISI 303 Stainless Steel
- Acciaio inox AISI 303 black idroglicer**
Black idroglicer AISI 303 Stainless Steel

CPUR MIRAFOX UTILITY RESCUE KNIFE - BACK LOCK (Con blocco di sicurezza - With safety lock)

FX-MIR 112



- N690Co**
- HRC 58-60**
- Black idroglicer**
- 4 mm - 0.16"**
- 235 g - 8.29 oz**
- G10 nero a trama grezza**
Coarse texture black G10

- Acciaio inox AISI 420 black idroglicer**
Black idroglicer AISI 420 Stainless Steel
- Acciaio inox AISI 420J2B black idroglicer**
Black idroglicer AISI 420J2B Stainless Steel
- N690Co black idroglicer**
- Acciaio inox AISI 303 black idroglicer**
Black idroglicer AISI 303 Stainless Steel
- Acciaio inox AISI 303 black idroglicer**
Black idroglicer AISI 303 Stainless Steel
- Nylon® 1000D con sistema MOLLE**
Nylon® 1000D with MOLLE system

NSN 5110150237459

R.C.S.T. FOLGORE RESCUE COMBAT KNIFE - LINER LOCK (Con blocco di sicurezza L.A.W.K.S. - With L.A.W.K.S.® safety lock)

FX-RCSTF-01



- N690Co**
- HRC 58-60**
- PVD (Physical Vapor Deposition)**
- 5 mm - 0.20"**
- 200 g - 7.05 oz**
- G10 nero a trama grezza**
Coarse texture black G10

- Acciaio inox AISI 420 black idroglicer**
Black idroglicer AISI 420 Stainless Steel
- Acciaio inox AISI 420J2B black idroglicer**
Black idroglicer AISI 420J2B Stainless Steel
- N690Co black idroglicer**
- Acciaio inox AISI 303 black idroglicer**
Black idroglicer AISI 303 Stainless Steel
- Acciaio inox AISI 303 black idroglicer**
Black idroglicer AISI 303 Stainless Steel
- Nylon® 1000D con sistema MOLLE**
Nylon® 1000D with MOLLE system

FOX R.C.S.T.F. LAMA TANTO+SEGA DLC COATED - LINER LOCK (Con blocco di sicurezza L.A.W.K.S. - With L.A.W.K.S.® safety lock)

FX-RCSTF-02









- N690Co**
- HRC 58-60**
- PVD (Physical Vapor Deposition)**
- 5 mm - 0.20"**
- 200 g - 7.05 oz**
- G10 nero a trama grezza**
Coarse texture black G10

- Acciaio inox AISI 420 black idroglicer**
Black idroglicer AISI 420 Stainless Steel
- Acciaio inox AISI 420J2B black idroglicer**
Black idroglicer AISI 420J2B Stainless Steel
- N690Co black idroglicer**
- Acciaio inox AISI 303 black idroglicer**
Black idroglicer AISI 303 Stainless Steel
- Acciaio inox AISI 303 black idroglicer**
Black idroglicer AISI 303 Stainless Steel
- Nylon® 1000D con sistema MOLLE**
Nylon® 1000D with MOLLE system

ADVANCE RESCUE AND COMBAT DIVER KNIFE - LINER LOCK (Con blocco di sicurezza L.A.W.K.S. - With L.A.W.K.S.® safety lock) **FX-401 OR**









-  **N690Co**
-  **HRC 58-60**
-  **Lucida**
Polished
-  **4 mm - 0.16"**
-  **135 g - 4.76 oz**
-  **G10 arancione a trama fine**
Fine texture orange G10

-  **Acciaio inox AISI 420 lucido**
Polished AISI 420 stainless steel
-  **Acciaio inox AISI 420J2B black idrogliider**
Black idrogliider AISI 420J2B Stainless Steel
-  **Acciaio inox AISI 420 lucido**
Polished AISI 420 stainless steel
-  **Acciaio inox AISI 303 black idrogliider**
Black idrogliider AISI 303 Stainless Steel
-  **Nylon® con lacci di gomma**
Nylon® with rubber straps

SPECWOG ALFA FOLDING KNIFE by Dean Rostohar - BACK LOCK (Con blocco di sicurezza - With safety lock) **FX-310**







-  **N690Co**
-  **HRC 58-60**
-  **PVD (Physical Vapor Deposition)**
-  **4 mm - 0.16"**
-  **245 g - 8.64 oz**
-  **G10 nero a trama grezza**
Coarse texture black G10

-  **Acciaio inox AISI 420 black idrogliider**
Black idrogliider AISI 420 Stainless Steel
-  **Acciaio inox AISI 420J2B black idrogliider**
Black idrogliider AISI 420J2B Stainless Steel
-  **Acciaio inox AISI 420 PVD**
PVD AISI 420 Stainless Steel
-  **Alluminio T6 6082 anodizzato nero**
Black anodized Aluminum T6 6082
-  **Acciaio inox AISI 304 rivestito al Nichel**
Nickel plated AISI 304 Stainless Steel

DEIMOS by Citadel - LINER LOCK (Con blocco di sicurezza L.A.W.K.S. - With L.A.W.K.S.® safety lock) **FX-0110 M**



-  **N690Co**
-  **HRC 58-60**
-  **Black idrogliider**
-  **4 mm - 0.16"**
-  **200 g - 7.05 oz**

-  **Micarta nera lavorata in 3D**
3D machined black Canvas Micarta
-  **Acciaio inox AISI 420 black idrogliider**
Black idrogliider AISI 420 Stainless Steel
-  **Acciaio inox AISI 420J2B black idrogliider**
Black idrogliider AISI 420J2B Stainless Steel
-  **Alluminio T6 6082 anodizzato nero**
Black anodized Aluminum T6 6082
-  **Acciaio inox AISI 304 rivestito al Nichel**
Nickel plated AISI 304 Stainless Steel

DEIMOS by Citadel - LINER LOCK (Con blocco di sicurezza L.A.W.K.S. - With L.A.W.K.S.® safety lock) **FX-0110 W**

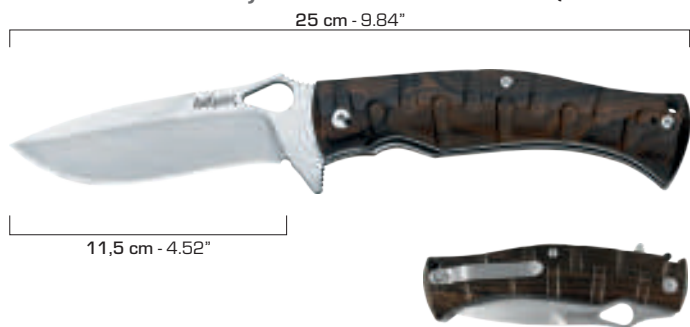







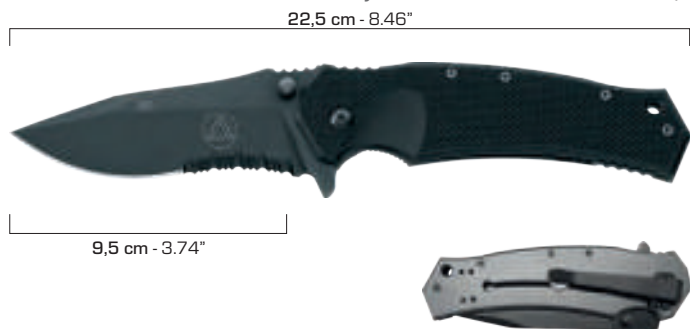

-  **N690Co**
-  **HRC 58-60**
-  **Satinata**
Satin
-  **4 mm - 0.16"**
-  **185 g - 6.52 oz**

-  **Legno di Ziricote lavorato in 3D**
3D machined Ziricote wood
-  **Acciaio inox AISI 420 lucido**
Polished AISI 420 Stainless Steel
-  **Acciaio inox AISI 420J2B black idrogliider**
Black idrogliider AISI 420J2B Stainless Steel
-  **Alluminio T6 6082 anodizzato nero**
Black anodized Aluminum T6 6082
-  **Acciaio inox AISI 304 lucido**
Polished AISI 304 Stainless Steel

COMBATIVE EDGE M1 SERIES by Rob Walker - FRAME LOCK (Con blocco di sicurezza L.A.W.K.S. - With L.A.W.K.S.® safety lock) **CED-01 S**



-  **N690Co**
-  **HRC 58-60**
-  **PVD (Physical Vapor Deposition)**
-  **4 mm - 0.16"**
-  **150 g - 5.29 oz**
-  **G10 nero a trama grezza**
Coarse texture black G10

-  **Titanio sabbiato**
Bead blasted Titanium
-  **Acciaio inox AISI 420J2B black idrogliider**
Black idrogliider AISI 420J2B Stainless Steel
-  **Acciaio inox AISI 420 black idrogliider**
Black idrogliider AISI 420 Stainless Steel
-  **Alluminio T6 6082 anodizzato nero**
Black anodized Aluminum T6 6082
-  **Acciaio inox AISI 304 rivestito al Nichel**
Nickel plated AISI 304 Stainless Steel





COLTELLI LAMA FISSA FKMD **FKMD FIXED BLADE KNIVES**

Che si tratti di una baionetta o di uno strumento di sopravvivenza in prima linea, il coltello lama fissa FKMD è a prova di campo di battaglia, non abbandonerà il fruitore nemmeno durante le operazioni più calde.

Whether it's a bayonet or a front-line survival tool, the FKMD fixed blade knife is battlefield-proof, it won't abandon the user even during the hottest operations.

NEW!

TACTICAL ELEMENTUM DAGGER - LAMA FISSA/FIXED BLADE

FX-647 S



- N690Co
- HRC 58-60
- Black idrogliker
- 3 mm - 0.12"

- 335 g - 11.81 oz**
- PP+TPE (polipropilene + termogomma) nero**
Black PP+TPE (Polypropylene + Thermorubber)
- Kydex® con laccio in Nylon® e MOLLE - lock clip**
Kydex® with Nylon® lace and MOLLE - lock clip

RIMOR - LAMA FISSA/FIXED BLADE

FX-9CM07

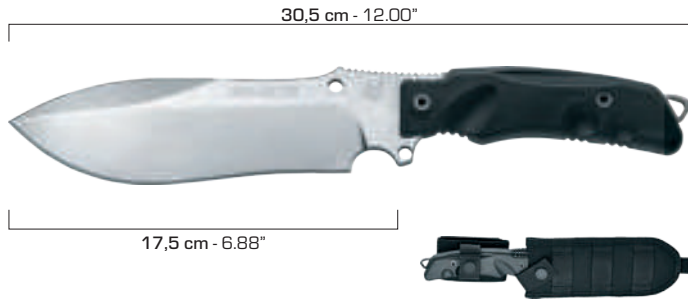

- N690Co
- HRC 58-60
- Stone washed
- 6 mm - 0.24"
- 360 g - 12.69 oz**

- FORPRENE® nero**
Black FORPRENE®
- Acciaio inox AISI 304 rivestito al Nichel**
Nickel plated AISI 304 Stainless Steel
- Nylon® con sistema MOLE**
Nylon® with MOLLE system

RIMOR - LAMA FISSA/FIXED BLADE

FX-9CM07 OD



- N690Co
- HRC 58-60
- Black idrogliker
- 6 mm - 0.24"
- 360 g - 12.69 oz**

- FORPRENE® verde OD**
OD green FORPRENE®
- Acciaio inox AISI 304 rivestito al Nichel**
Nickel plated AISI 304 Stainless Steel
- Nylon® con sistema MOLLE**
Nylon® with MOLLE system

FOX ARDITI collab. prof Antonio G. G. Merendoni - LAMA FISSA/FIXED BLADE

FX-595

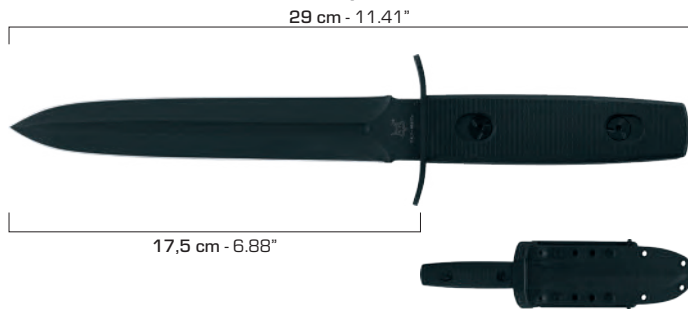

- N690Co
- HRC 58-60
- Cerakote™ Black
- 4 mm - 0.16"
- 255 g - 8.99 oz**

- G10 nero lavorato in 3D**
3D machined black G10
- Acciaio inox AISI 303 black idrogliker**
Black idrogliker AISI 303 Stainless Steel
- Kydex® con MOLLE - lock clip**
Kydex® with MOLLE - lock clip

FOX ARDITI collab. prof Antonio G. G. Merendoni - LAMA FISSA/FIXED BLADE

FX-595 W



- N690Co
- HRC 58-60
- Satinata Satin
- 4 mm - 0.16"
- 211 g - 7.44 oz**

- Legno di Ziricote lavorato in 3D**
3D machined Ziricote wood
- Acciaio inox AISI 303 lucido**
Polished AISI 303 Stainless Steel
- Cuoio**
Leather





AVES ITALIAN HELICOPTER CREW SURVIVAL KNIFE - LAMA FISSA/FIXED BLADE





FX-AVES12

28 cm - 11.02"



14 cm - 5.51"

-  N690Co
-  HRC 58-60
-  PVD (Physical Vapor Deposition)
-  6 mm - 0.24"
-  495 g - 17.46 oz

-  G10 nero a trama grezza. Contiene pietra per affilare - Coarse texture black G10. Contains sharpening stone
-  Acciaio inox AISI 303 black idroglicer Black idroglicer AISI 303 Stainless Steel
-  Nylon® 1000D con sistema MOLLE + copertura protettiva in Kydex® Nylon® 1000D with MOLLE system + Kydex® protection sleeve
-  Acciarino incluso Fire starter included

MARS COLLECTION - SPUTNIK 5 - LAMA FISSA/FIXED BLADE

FX-805 B



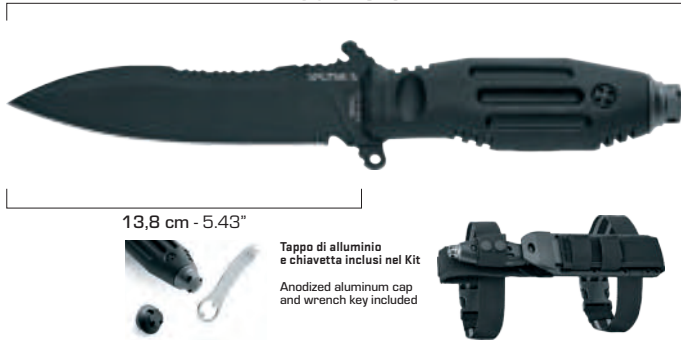

26 cm - 10.23"







13,8 cm - 5.43"



Tappe di alluminio e chiavetta inclusi nel Kit
Anodized aluminum cap and wrench key included

-  N690Co
-  HRC 58-60
-  Cerakote™ Black
-  5 mm - 0.20"
-  230 g - 8.11 oz

-  TPR nero Black TPR
-  Acciaio inox AISI 420 temperato PVD PVD Tempered AISI 420 stainless steel
-  Acciaio inox AISI 303 black idroglicer Black idroglicer AISI 303 Stainless Steel
-  Nylon® 1000D con sistema MOLLE e sede in FRN® (Nylon® rinforzato con fibra di vetro) 1000D Nylon® with MOLLE system and FRN® (Fiberglass Reinforced Nylon®) sleeve

MARS COLLECTION - SPUTNIK 10 - LAMA FISSA/FIXED BLADE

FX-810 B





24,5 cm - 9.64"



12 cm - 4.72"



Tappe di alluminio e chiavetta inclusi nel Kit
Anodized aluminum cap and wrench key included

-  N690Co
-  HRC 58-60
-  Cerakote™ Black
-  5 mm - 0.20"
-  215 g - 7.58 oz

-  TPR nero Black TPR
-  Acciaio inox AISI 420 temperato PVD PVD Tempered AISI 420 stainless steel
-  Acciaio inox AISI 303 black idroglicer Black idroglicer AISI 303 Stainless Steel
-  Nylon® 1000D con sistema MOLLE e sede in FRN® (Nylon® rinforzato con fibra di vetro) 1000D Nylon® with MOLLE system and FRN® (Fiberglass Reinforced Nylon®) sleeve

MARS COLLECTION - SPUTNIK 11 - LAMA FISSA/FIXED BLADE

FX-811 B



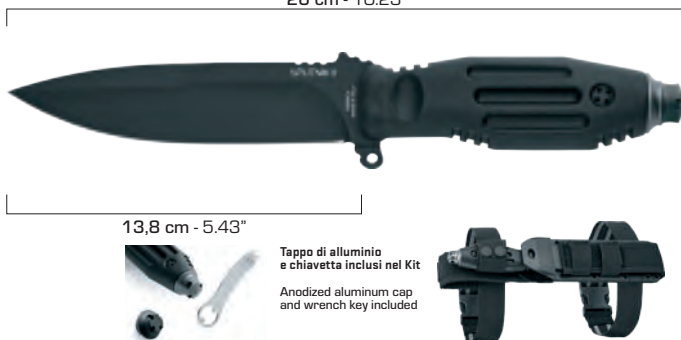

26 cm - 10.23"







13,8 cm - 5.43"



Tappe di alluminio e chiavetta inclusi nel Kit
Anodized aluminum cap and wrench key included

-  N690Co
-  HRC 58-60
-  Cerakote™ Black
-  5 mm - 0.20"
-  230 g - 8.11 oz

-  TPR nero Black TPR
-  Acciaio inox AISI 420 temperato PVD PVD Tempered AISI 420 stainless steel
-  Acciaio inox AISI 303 black idroglicer Black idroglicer AISI 303 Stainless Steel
-  Nylon® 1000D con sistema MOLLE e sede in FRN® (Nylon® rinforzato con fibra di vetro) 1000D Nylon® with MOLLE system and FRN® (Fiberglass Reinforced Nylon®) sleeve

MARS COLLECTION - SPUTNIK 13 - LAMA FISSA/FIXED BLADE

FX-813 B





28 cm - 11.02"







15,3 cm - 6.02"



Tappe di alluminio e chiavetta inclusi nel Kit
Anodized aluminum cap and wrench key included

-  N690Co
-  HRC 58-60
-  Cerakote™ Black
-  5 mm - 0.20"
-  230 g - 8.11 oz



-  TPR nero Black TPR
-  Acciaio inox AISI 420 temperato PVD PVD Tempered AISI 420 stainless steel
-  Acciaio inox AISI 303 black idroglicer Black idroglicer AISI 303 Stainless Steel
-  Nylon® 1000D con sistema MOLLE e sede in FRN® (Nylon® rinforzato con fibra di vetro) 1000D Nylon® with MOLLE system and FRN® (Fiberglass Reinforced Nylon®) sleeve

RECON by Alessandro Zanin - LAMA FISSA/FIXED BLADE

FX-512 OD







-  **N690Co**
-  **HRC 58-60**
-  **Sabbiato**
Bead blasted
-  **5 mm - 0.20"**
-  **300 g - 10.58 oz**

-  **Micarta verde OD sagomata**
Contoured OD green Micarta
-  **Acciaio inox AISI 303 lucido**
Polished AISI 303 Stainless Steel
-  **Kydex® con MOLLE - lock clip**
Kydex® with MOLLE - lock clip

RECON by Alessandro Zanin - LAMA FISSA/FIXED BLADE

FX-512



-  **N690Co**
-  **HRC 58-60**
-  **Cerakote™ Black**
-  **5 mm - 0.20"**
-  **300 g - 10.58 oz**

-  **G10 nero sagomata**
Contoured black G10
-  **Acciaio inox AISI 303 lucido**
Polished AISI 303 Stainless Steel
-  **Kydex® con MOLLE - lock clip**
Kydex® with MOLLE - lock clip

PANABAS - LAMA FISSA/FIXED BLADE

FX-509 CT



-  **N690Co**
-  **HRC 58-60**
-  **Cerakote™ tan**
-  **6 mm - 0.24"**
-  **340 g - 11.99 oz**

-  **FORPRENE® coyote tan**
Coyote tan FORPRENE®
-  **Acciaio inox AISI 304 rivestito al Nichel**
Nickel plated AISI 304 Stainless Steel
-  **Nylon® con sistema MOLLE**
Nylon® with MOLLE system

Kit di sopravvivenza incluso nel fodero
Survival kit included with the sheath

PARANG by Alfredo Doricchi - LAMA FISSA/FIXED BLADE

FX-0107153



-  **N690Co**
-  **HRC 58-60**
-  **Top Shield® black**
-  **6 mm - 0.24"**
-  **340 g - 11.99 oz**





-  **FORPRENE® coyote tan**
Coyote tan FORPRENE®
-  **Acciaio inox AISI 304 rivestito al Nichel**
Nickel plated AISI 304 Stainless Steel
-  **Nylon® con sistema MOLLE**
Nylon® with MOLLE system

Kit di sopravvivenza incluso nel fodero
Survival kit included with the sheath

PARUS - LAMA FISSA/FIXED BLADE

FX-9CM06



-  **N690Co**
-  **HRC 58-60**
-  **Black idrogliker**
-  **6 mm - 0.24"**
-  **340 g - 11.99 oz**

-  **FORPRENE® nero**
Black FORPRENE®
-  **Acciaio inox AISI 304 rivestito al Nichel**
Nickel plated AISI 304 Stainless Steel
-  **Nylon® con sistema MOLLE**
Nylon® with MOLLE system

Kit di sopravvivenza incluso nel fodero
Survival kit included with the sheath

FOX EXTREME TACTICAL KUKRI by Boris Sterm - LAMA FISSA/FIXED BLADE

FX-9CM04BT







-  N690Co
- HRC** 58-60
-  Cerakote™ tan
-  6 mm - 0.24"
-  450 g - 15.87 oz

-  **FORPRENE® verde OD**
OD green FORPRENE®
-  **Acciaio inox AISI 304 rivestito al Nichel**
Nickel plated AISI 304 Stainless Steel
-  **Nylon® con sistema MOLLE**
Nylon® with MOLLE system

FOX EXTREME TACTICAL KUKRI by Boris Sterm - LAMA FISSA/FIXED BLADE

FX-9CM04T



-  N690Co
- HRC** 58-60
-  Black idrogliker
-  6 mm - 0.24"
-  450 g - 15.87 oz

-  **FORPRENE® nero**
Black FORPRENE®
-  **Acciaio inox AISI 304 rivestito al Nichel**
Nickel plated AISI 304 Stainless Steel
-  **Nylon® con sistema MOLLE**
Nylon® with MOLLE system

FOX EXTREME TACTICAL KUKRI by Boris Sterm - LAMA FISSA/FIXED BLADE

FX-9CM05BT







-  N690Co
- HRC** 58-60
-  Cerakote™ tan
-  6 mm - 0.24"
-  450 g - 15.87 oz

-  **FORPRENE® verde OD**
OD green FORPRENE®
-  **Acciaio inox AISI 304 rivestito al Nichel**
Nickel plated AISI 304 Stainless Steel
-  **Nylon® con sistema MOLLE**
Nylon® with MOLLE system

FOX EXTREME TACTICAL KUKRI by Boris Sterm - LAMA FISSA/FIXED BLADE

FX-9CM05T







-  N690Co
- HRC** 58-60
-  Black idrogliker
-  6 mm - 0.24"
-  450 g - 15.87 oz

-  **FORPRENE® nero**
Black FORPRENE®
-  **Acciaio inox AISI 304 rivestito al Nichel**
Nickel plated AISI 304 Stainless Steel
-  **Nylon® con sistema MOLLE**
Nylon® with MOLLE system

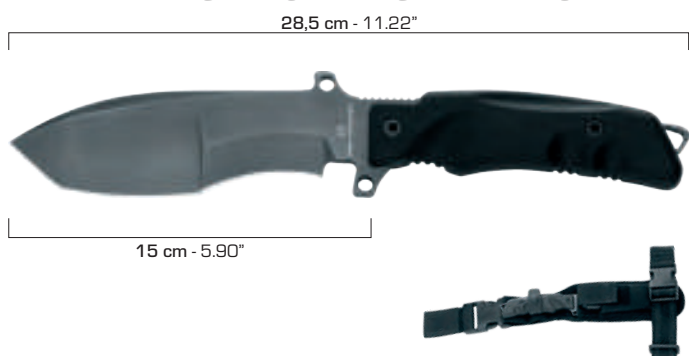
TRACKER UTILITY CAMP AND SNIPER KNIFE - LAMA FISSA/FIXED BLADE

FX-9CM01B







-  N690Co
- HRC** 58-60
-  PVD (Physical Vapor Deposition)
-  6 mm - 0.24"
-  310 g - 10.93 oz

-  **FORPRENE® nero**
Black FORPRENE®
-  **Acciaio inox AISI 304 rivestito al Nichel**
Nickel plated AISI 304 Stainless Steel
-  **Nylon® con sistema MOLLE**
Nylon® with MOLLE system

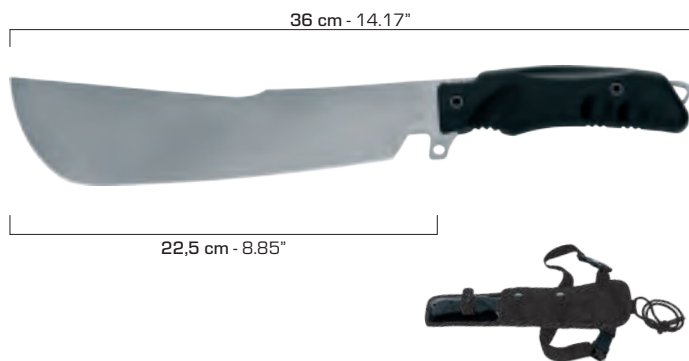
GOLOK HITAM MACHETE FIGHTING BLADE - LAMA FISSA/FIXED BLADE

FX-9CM02B







-  **N690Co**
- HRC 58-60**
-  **PVD (Physical Vapor Deposition)**
-  **6 mm - 0.24"**
-  **385 g - 13.58 oz**

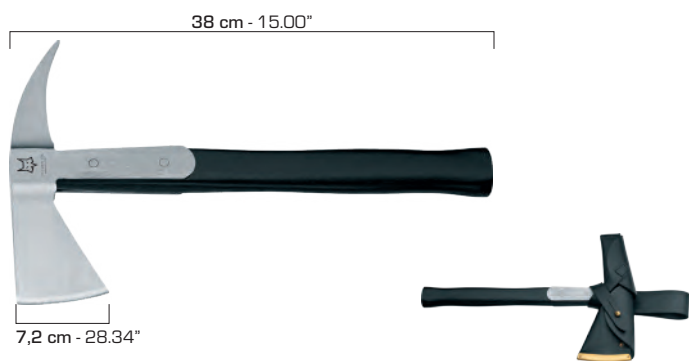

-  **FORPRENE® nero**
Black FORPRENE®
-  **Acciaio inox AISI 304 rivestito al Nichel**
Nickel plated AISI 304 Stainless Steel
-  **Nylon®**

OFFICIAL ISSUE ITALIAN FIRE BRIGADE AXE - LAMA FISSA/FIXED BLADE

FX-MIR115/2VVF







-  **Forged Carbon Steel AISI C70**
- HRC 50-52**
-  **Satinata**
Satin
-  **20 - 3 mm - 0.78 - 0.11"**
-  **930 g - 35.27 oz**

-  **Frassino verniciato**
Painted ash wood
-  **Cuoio**
Leather

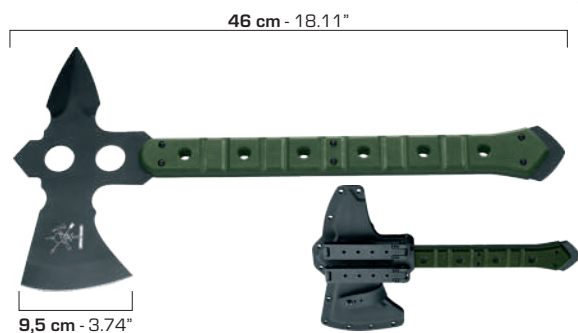
ATC COMANCHE FIGHTING TOMAHAWK by Shane Sibert - LAMA FISSA/FIXED BLADE

FX-ATC01







-  **N690Co**
- HRC 58-60**
-  **Black idroglider**
-  **5 mm - 0.20"**
-  **1000 g - 35.27 oz**

-  **G10 verde OD a trama grezza**
Coarse texture OD green G10
-  **Acciaio inox AISI 304 rivestito al Nichel**
Nickel plated AISI 304 Stainless Steel
-  **Kydex® con MOLLE - lock**
Kydex® with MOLLE - lock

ATC COMANCHE FIGHTING TOMAHAWK by Shane Sibert - LAMA FISSA/FIXED BLADE

FX-ATC02







-  **N690Co**
- HRC 58-60**
-  **Black idroglider**
-  **5 mm - 0.20"**
-  **845 g - 29.80 oz**



-  **G10 verde OD a trama grezza**
Coarse texture OD green G10
-  **Acciaio inox AISI 304 rivestito al Nichel**
Nickel plated AISI 304 Stainless Steel
-  **Kydex® con MOLLE - lock**
Kydex® with MOLLE - lock

COMBATIVE EDGE SALUS by Rob Walker - LAMA FISSA/FIXED BLADE

FX-CED-M2C



-  **N690Co**
- HRC 58-60**
-  **PVD (Physical Vapor Deposition)**
-  **5 mm - 0.20"**
-  **305 g - 10.75 oz**



-  **G10 nero lavorato in 3D**
3D machined black G10
-  **Acciaio inox AISI 304 rivestito al Nichel**
Nickel plated AISI 304 Stainless Steel
-  **Nylon® con sistema MOLLE**
Nylon® with MOLLE system

VENGEANCE by Jerry Hossom - LAMA FISSA/FIXED BLADE

FX-601







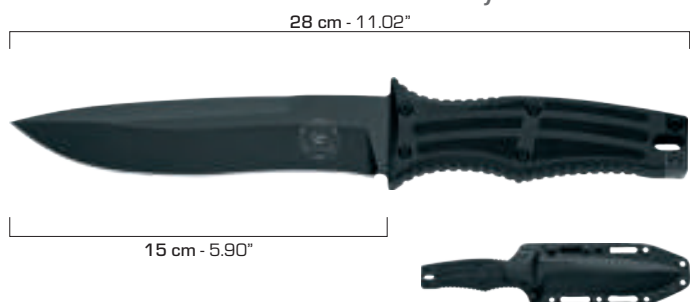

-  **N690Co**
-  **HRC 58-60**
-  **Sabbiata**
Bead blasted
-  **5 mm - 0.20"**
-  **315 g - 11.11 oz**

-  **Micarta verde**
Canvas Micarta green
-  **Acciaio inox AISI 304 lucido**
Polished AISI 304 Stainless Steel
-  **Kydex® con TEK-LOK clip**
Kydex® with TEK-LOK clip

SPEAR TECH KNIVES by Antonio di Gennaro - LAMA FISSA/FIXED BLADE

FX-0171112







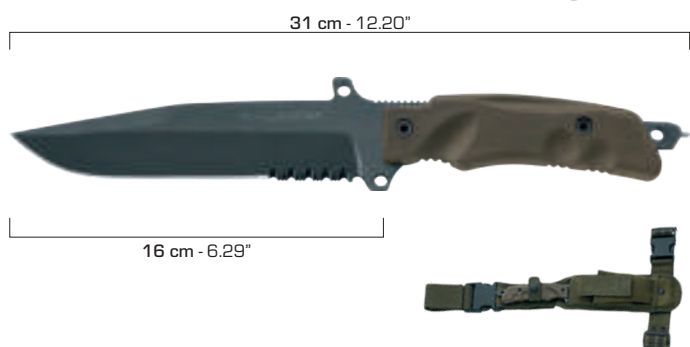

-  **N690Co**
-  **HRC 58-60**
-  **Black idroglider**
-  **6 mm - 0.24"**
-  **305 g - 10.75 oz**

-  **G10 nero a trama grezza**
Coarse texture black G10
-  **Acciaio inox AISI 304 rivestito al Nichel**
Nickel plated AISI 304 Stainless Steel
-  **Kydex® e Nylon® con sistema MOLLE e MOLLE-lock clip**
Kydex® and Nylon® with MOLLE system and MOLLE-lock clip

FOX-X LANDER - LAMA FISSA/FIXED BLADE

FX-0171109







-  **Beta titanium**
-  **HRC 47-49**
-  **PVD (Physical Vapor Deposition)**
-  **6 mm - 0.24"**
-  **135 g - 4.76 oz**

-  **FORPRENE® coyote tan**
Coyote tan FORPRENE®
-  **Tungsteno**
Tungsten
-  **Acciaio inox AISI 304 rivestito al Nichel**
Nickel plated AISI 304 Stainless Steel
-  **Nylon® 1000 D con sistema MOLLE**
Nylon® 1000 D with MOLLE system

N.E.R.O. EXTREME RESPONSE OPERATIONS - LAMA FISSA/FIXED BLADE

FX-NR03 CT







-  **N690Co**
-  **HRC 58-60**
-  **Black idroglider**
-  **5 mm - 0.20"**
-  **270 g - 9.52 oz**

-  **G10 nero a trama grezza**
Coarse texture black G10
-  **Acciaio inox AISI 304 rivestito al Nichel**
Nickel plated AISI 304 Stainless Steel
-  **Nylon® 1000 D con sistema MOLLE**
Nylon® 1000 D with MOLLE system

N.E.R.O. EXTREME RESPONSE OPERATIONS - LAMA FISSA/FIXED BLADE

FX-NR01 TT



-  **N690Co**
-  **HRC 58-60**
-  **Black idroglider**
-  **5 mm - 0.20"**
-  **305 g - 10.70 oz**



-  **G10 nero a trama grezza**
Coarse texture black G10
-  **Acciaio inox AISI 304 rivestito al Nichel**
Nickel plated AISI 304 Stainless Steel
-  **Nylon® 1000 D con sistema MOLLE**
Nylon® 1000 D with MOLLE system

SERIE E.T.K. EXAGON TACTICAL KNIVES - LAMA FISSA/FIXED BLADE

FX-1661TK



-  **AISI 440C**
- HRC 56-58**
-  **Sabbia**
Bead blasted
-  **5 mm - 0.20"**
-  **320 g - 11.28 oz**

-  **Micarta tela verde americana**
American green canvas Micarta
-  **Acciaio inox AISI 303 sabbia**
Bead blasted AISI 303 Stainless Steel
-  **Nylon® 1000 D con sistema MOLLE**
Nylon® 1000 D with MOLLE system

SERIE E.T.K. EXAGON TACTICAL KNIVES - LAMA FISSA/FIXED BLADE

FX-1663TK



-  **AISI 440C**
- HRC 56-58**
-  **Sabbia**
Bead blasted
-  **5 mm - 0.20"**
-  **320 g - 11.28 oz**

-  **Micarta tela verde americana**
American green canvas Micarta
-  **Acciaio inox AISI 303 sabbia**
Bead blasted AISI 303 Stainless Steel
-  **Nylon® 1000 D con sistema MOLLE**
Nylon® 1000 D with MOLLE system

SERIE E.T.K. EXAGON TACTICAL KNIVES - LAMA FISSA/FIXED BLADE

FX-1665TK



-  **AISI 440C**
- HRC 56-58**
-  **Sabbia**
Bead blasted
-  **4 mm - 0.16"**
-  **170 g - 5.99 oz**

-  **Micarta tela verde americana**
American green canvas Micarta
-  **Acciaio inox AISI 303 sabbia**
Bead blasted AISI 303 Stainless Steel
-  **Nylon® 1000 D con sistema MOLLE**
Nylon® 1000 D with MOLLE system

SERIE E.T.K. EXAGON TACTICAL KNIVES - LAMA FISSA/FIXED BLADE

FX-1666TK







-  **AISI 440C**
- HRC 56-58**
-  **Sabbia**
Bead blasted
-  **4 mm - 0.16"**
-  **170 g - 5.99 oz**

-  **Micarta tela verde americana**
American green canvas Micarta
-  **Acciaio inox AISI 303 sabbia**
Bead blasted AISI 303 Stainless Steel
-  **Nylon® 1000 D con sistema MOLLE**
Nylon® 1000 D with MOLLE system

AFGHANISTAN MEMORIAL KNIFE by Hill Knives - LAMA FISSA/FIXED BLADE

AMK-279





-  **N690Co**
- HRC 58-60**
-  **PVD (Physical Vapor Deposition)**
-  **4,5 mm - 0.18"**
-  **220 g - 7.76 oz**

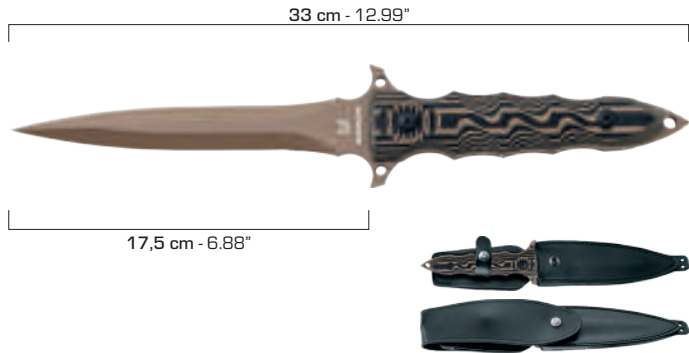



-  **Micarta tela naturale sagomata**
Contoured natural Canvas Micarta
-  **Acciaio inox AISI 303 black idroglicer**
Black idroglicer AISI 303 Stainless Steel
-  **Kydex® con MOLLE - lock clip**
Kydex® with MOLLE - lock clip

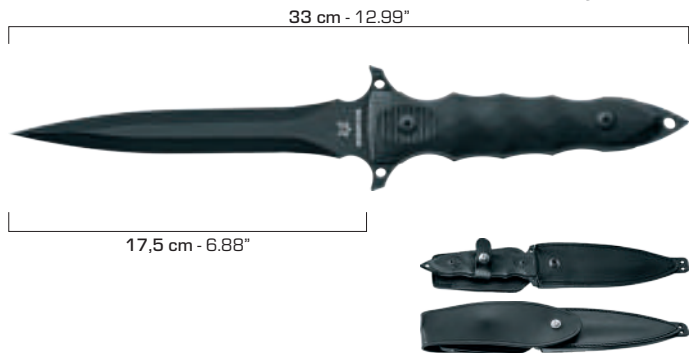

MODRAS by Borut Kincl - LAMA FISSA/FIXED BLADE**FX-508**

-  N690Co
- HRC** 58-60
-  Coyote tan idrogliker
-  6 mm - 0.24"
-  340 g - 11.99 oz

-  **G10 multicolore lavorato in 3D**
3D machined multicolor G10
-  **Acciaio inox AISI 303 nero Cerakote™**
Cerakote™black AISI 303 Stainless Steel
-  **Cuoio**
Leather



MODRAS by Borut Kincl - LAMA FISSA/FIXED BLADE**FX-507**

-  N690Co
- HRC** 58-60
-  Black idrogliker
-  6 mm - 0.24"
-  340 g - 11.99 oz

-  **G10 nero lavorato in 3D**
3D machined black G10
-  **Acciaio inox AISI 303 nero Cerakote™**
Cerakote™black AISI 303 Stainless Steel
-  **Cuoio**
Leather



BELLUM DAGA by Gabriel A. Serman - LAMA FISSA/FIXED BLADE**FX-0171100**

-  N690Co
- HRC** 58-60
-  Black idrogliker
-  6 mm - 0.24"
-  275 g - 9.70 oz

-  **G10 nero lavorato in 3D**
3D machined black G10
-  **Acciaio inox AISI 420 temprato black idrogliker**
Black idrogliker tempered AISI 420 Stainless Steel
-  **Acciaio inox AISI 304 rivestito al Nichel**
Nickel plated AISI 304 Stainless Steel
-  **Nylon® e Kydex® con sistema MOLLE**
Nylon® and Kydex® with MOLLE system



ORIGINAL MARINES COMBAT KNIVES - LAMA FISSA/FIXED BLADE**FX-1682**

-  AISI 440C
- HRC** 55-57
-  Satinata
Satin
-  5 mm - 0.20"

-  220 g - 7.76 oz
-  **Cuoio. Elsa in acciaio inox AISI 304**
Leather. AISI 304 Stainless Steel pommel and guard
-  **Cuoio**
Leather

ORIGINAL MARINES COMBAT KNIVES - LAMA FISSA/FIXED BLADE**FX-1694**

-  AISI 440C
- HRC** 55-57
-  Satinata
Satin
-  5 mm - 0.20"

-  220 g - 7.76 oz
-  **Cuoio. Elsa in acciaio inox AISI 304**
Leather. AISI 304 Stainless Steel pommel and guard
-  **Cuoio**
Leather





KUKU HANUMAN KARAMBIT by Richard Derespina - LAMA FISSA/FIXED BLADE**FX-636T**

-  **N690Co**
- HRC 58-60**
-  **Black idroglider**
-  **4 mm - 0.16"**



-  **165 g - 5.82 oz**
-  **G10 nero a trama grezza**
Coarse texture black G10
-  **Acciaio inox AISI 303 black idroglider**
Black idroglider AISI 303 Stainless Steel
-  **Kydex® con MOLLE - lock clip**
Kydex® with MOLLE - lock clip

PARONG by Richard Derespina - LAMA FISSA/FIXED BLADE**FX-637T**

-  **N690Co**
- HRC 58-60**
-  **Black idroglider**
-  **4 mm - 0.16"**





-  **190 g - 6.70 oz**
-  **G10 nero a trama grezza**
Coarse texture black G10
-  **Acciaio inox AISI 303 black idroglider**
Black idroglider AISI 303 Stainless Steel
-  **Kydex® con MOLLE - lock clip**
Kydex® with MOLLE - lock clip

PARONG by Richard Derespina - LAMA FISSA/FIXED BLADE**6370L**

-  **N690Co**
- HRC 58-60**
-  **Satinata**
Satin
-  **4 mm - 0.16"**





-  **231 g - 8.14 oz**
-  **Legno di Ulivo**
Olive Wood
-  **Acciaio inox AISI 303 black idroglider**
Black idroglider AISI 303 Stainless Steel
-  **Cuoio**
Leather

PREDATOR - SPETSNAZ - LAMA FISSA/FIXED BLADE**FX-G4BS**

-  **N690Co**
- HRC 58-60**
-  **Black idroglider**
-  **6 mm - 0.24"**
-  **300 g - 10.58 oz**

-  **FORPRENE® nero**
Black FORPRENE®
-  **Acciaio inox AISI 304 rivestito al Nichel**
Nickel plated AISI 304 Stainless Steel
-  **Nylon® 1000D con sistema MOLLE**
Nylon® 1000D with MOLLE system

PREDATOR - SPETSNAZ - LAMA FISSA/FIXED BLADE**FX-G4B**

-  **N690Co**
- HRC 58-60**
-  **Black idroglider**
-  **5 mm - 0.20"**
-  **304 g - 10.72 oz**

-  **FORPRENE® nero**
Black FORPRENE®
-  **Acciaio inox AISI 304 rivestito al Nichel**
Nickel plated AISI 304 Stainless Steel
-  **Nylon® 1000D con sistema MOLLE**
Nylon® 1000D with MOLLE system

TARANIS - LAMA FISSA/FIXED BLADE

FX-0171114

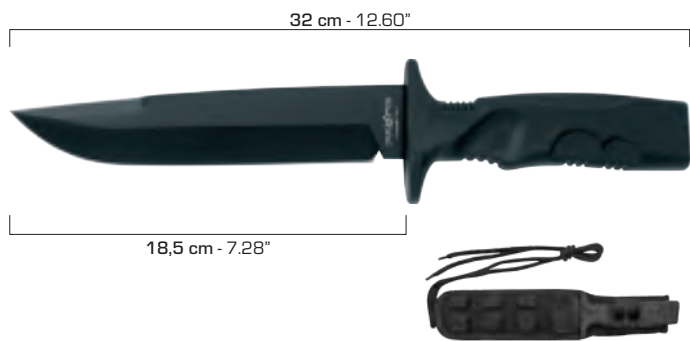

- N690Co
- HRC 58-60
- Black idroglider
- 5 mm - 0.20"
- 304 g - 10.72 oz

- FORPRENE® nero**
Black FORPRENE®
- Acciaio inox AISI 303 Mil Spec**
Mil Spec AISI 303 Stainless Steel
- Nylon® 1000D con sistema MOLLE**
Nylon® 1000D with MOLLE system

TARANIS - LAMA FISSA/FIXED BLADE

FX-0171115

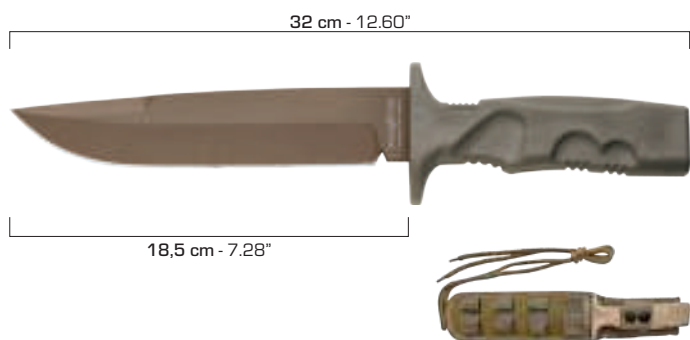

- N690Co
- HRC 58-60
- Coyote tan idroglider
- 5 mm - 0.20"
- 304 g - 10.72 oz

- FORPRENE® coyote tan**
Coyote tan FORPRENE®
- Acciaio inox AISI 303 Mil Spec**
Mil Spec AISI 303 Stainless Steel
- Nylon® 1000D con sistema MOLLE**
Nylon® 1000D with MOLLE system

FIRE BRIGADE RESCUE AND EMERGENCY KNIFE - LAMA FISSA/FIXED BLADE

FX-0171101 B



- N690Co
- HRC 58-60
- Black idroglider
- 5 mm - 0.20"
- 245 g - 8.64 oz

- FORPRENE® nero**
Black FORPRENE®
- Acciaio inox AISI 420 temprato Black idroglider** - Black idroglider tempered AISI 420 stainless steel
- Kydex® con MOLLE - Lock clip**
Kydex® with MOLLE - Lock clip

FIRE BRIGADE RESCUE AND EMERGENCY KNIFE - LAMA FISSA/FIXED BLADE

FX-0171101 CT



- N690Co
- HRC 58-60
- Black idroglider
- 5 mm - 0.20"
- 245 g - 8.64 oz

- FORPRENE® coyote tan**
Coyote tan FORPRENE®
- Acciaio inox AISI 420 temprato Black idroglider** - Black idroglider tempered AISI 420 stainless steel
- Kydex® con MOLLE - Lock clip**
Kydex® with MOLLE - Lock clip

FIRE BRIGADE RESCUE AND EMERGENCY KNIFE - LAMA FISSA/FIXED BLADE

FX-0171102

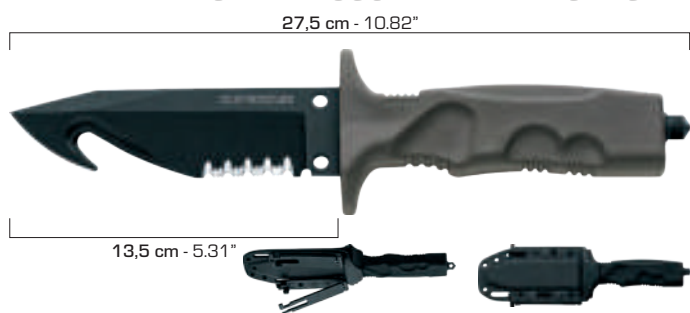

- N690Co
- HRC 58-60
- Black idroglider
- 5 mm - 0.20"
- 225 g - 7.93 oz

- FORPRENE® verde OD**
OD green FORPRENE®
- Acciaio inox AISI 420 temprato Black idroglider** - Black idroglider tempered AISI 420 stainless steel
- Kydex® con MOLLE - Lock clip**
Kydex® with MOLLE - Lock clip



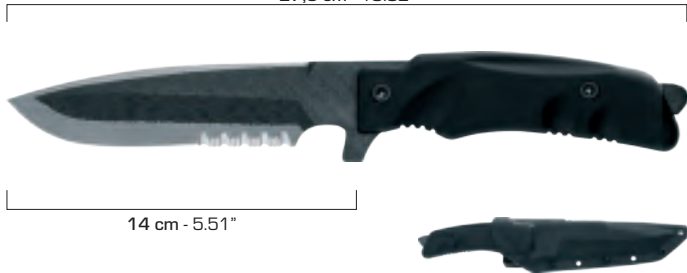

FOX STEALTH CARBON TITANIUM - LAMA FISSA/FIXED BLADE

FX-SCT02B

27,5 cm - 10.82"



14 cm - 5.51"

-  **Titanio grado 5 + fibra di carbonio**
Titanium grade 5 + carbon fiber
- HRC 45**
-  **Sabbiata**
Bead blasted
-  **6 mm - 0.24"**
-  **135 g - 4.76 oz**

-  **FORPRENE® nero**
Black FORPRENE®
-  **Acciaio inox AISI 304 rivestito al Nichel**
Nickel plated AISI 304 Stainless Steel
-  **Kydex® con MOLLE - Lock clip**
Kydex® with MOLLE - Lock clip

FOX LEONIDA - COMBAT SURVIVAL KNIFE - LAMA FISSA/FIXED BLADE

FX-0171106

31 cm - 12.20"

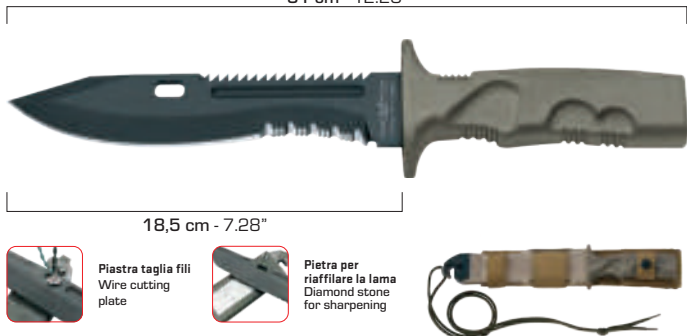





18,5 cm - 7.28"



Piastra taglia fili
Wire cutting plate



Pietra per riaffilare la lama
Diamond stone for sharpening

-  **N690Co**
- HRC 58-60**
-  **Black idrogliker**
-  **5 mm - 0.20"**
-  **285 g - 10.05 oz**

-  **FORPRENE® verde OD**
OD green FORPRENE®
-  **Acciaio inox AISI 303 Mil Spec**
Mil Spec AISI 303 Stainless Steel
-  **Nylon® 1000D con sistema MOLLE e sede in FRN® (Nylon® rinforzato con fibra di vetro)**
1000D Nylon® with MOLLE system and FRN® (Fiberglass Reinforced Nylon®) sleeve

FOX LEONIDA - COMBAT SURVIVAL KNIFE - LAMA FISSA/FIXED BLADE

FX-0171107

31 cm - 12.20"







18,5 cm - 7.28"



Piastra taglia fili
Wire cutting plate



Pietra per riaffilare la lama
Diamond stone for sharpening

-  **N690Co**
- HRC 58-60**
-  **Black idrogliker**
-  **5 mm - 0.20"**
-  **285 g - 10.05 oz**

-  **FORPRENE® nero**
Black FORPRENE®
-  **Acciaio inox AISI 303 Mil Spec**
Mil Spec AISI 303 Stainless Steel
-  **Nylon® 1000D con sistema MOLLE e sede in FRN® (Nylon® rinforzato con fibra di vetro)**
1000D Nylon® with MOLLE system and FRN® (Fiberglass Reinforced Nylon®) sleeve

FOX LEONIDA - BAYONET KNIFE - LAMA FISSA/FIXED BLADE

FX-0193001

31 cm - 12.20"

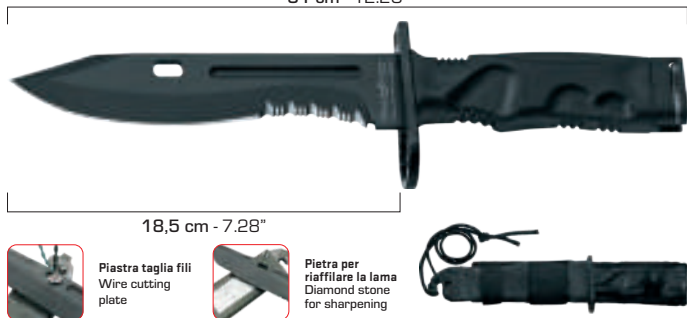





18,5 cm - 7.28"





Piastra taglia fili
Wire cutting plate



Pietra per riaffilare la lama
Diamond stone for sharpening

-  **N690Co**
- HRC 58-60**
-  **Black idrogliker**
-  **5 mm - 0.20"**
-  **295 g - 10.40 oz**

-  **FORPRENE® nero. Elsa AISI 420 black idrogliker.**
Black FORPRENE®, Black idrogliker AISI 420 pommel
-  **Acciaio inox AISI 303 Mil Spec**
Mil Spec AISI 303 Stainless Steel
-  **Nylon® 1000D con sistema MOLLE e sede in FRN® (Nylon® rinforzato con fibra di vetro)**
1000D Nylon® with MOLLE system and FRN® (Fiberglass Reinforced Nylon®) sleeve

FOX LEONIDA - BAYONET KNIFE - LAMA FISSA/FIXED BLADE

FX-0193000

31 cm - 12.20"







18,5 cm - 7.28"



Piastra taglia fili
Wire cutting plate



Pietra per riaffilare la lama
Diamond stone for sharpening

-  **N690Co**
- HRC 58-60**
-  **Black idrogliker**
-  **5 mm - 0.20"**
-  **295 g - 10.40 oz**

-  **FORPRENE® verde OD. Elsa AISI 420 black idrogliker.**
OD green FORPRENE®, Black idrogliker AISI 420 pommel
-  **Acciaio inox AISI 303 Mil Spec**
Mil Spec AISI 303 Stainless Steel
-  **Nylon® 1000D con sistema MOLLE e sede in FRN® (Nylon® rinforzato con fibra di vetro)**
1000D Nylon® with MOLLE system and FRN® (Fiberglass Reinforced Nylon®) sleeve

FOX STEALTH CARBON TITANIUM - LAMA FISSA/FIXED BLADE

FX-SCT01B

29,5 cm - 11.61"



16 cm - 6.29"

Titanio grado 5 + fibra di carbonio
Titanium grade 5 + carbon fiber

HRC 45

Sabbia
Bead blasted

6 mm - 0.24"

155 g - 5.46 oz



FORPRENE® nero
Black FORPRENE®
Acciaio inox AISI 304 rivestito al
Nichel
Nickel plated AISI 304 Stainless Steel
Kydex® con TEK- LOK clip
Kydex® with TEK- LOK clip



FOX OPLITA - COMBAT KNIFE - LAMA FISSA/FIXED BLADE

FX-0171116

31 cm - 12.20"

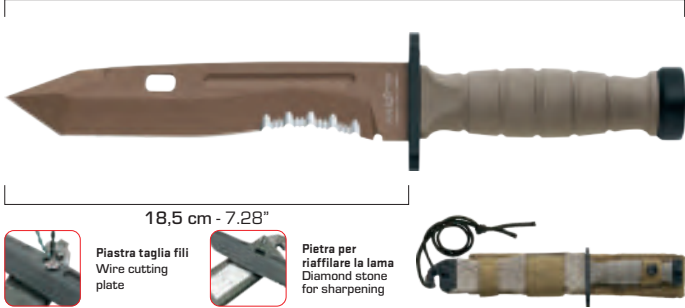

18,5 cm - 7.28"



Piastra taglia fili
Wire cutting
plate



**Pietra per
riaffilare la lama**
Diamond stone
for sharpening

N690Co

HRC 58-60

Coyote tan idroglider

5 mm - 0.20"

285 g - 10.05 oz



KRATON G coyote tan
Coyote tan KRATON G
**Nylon® 1000D con sistema MOLLE e sede
in FRN® (Nylon® rinforzato con fibra di vetro)**
1000D Nylon® with MOLLE system and
FRN® (Fiberglass Reinforced Nylon®) sleeve



FOX OPLITA - COMBAT KNIFE - LAMA FISSA/FIXED BLADE

FX-0171117

31 cm - 12.20"

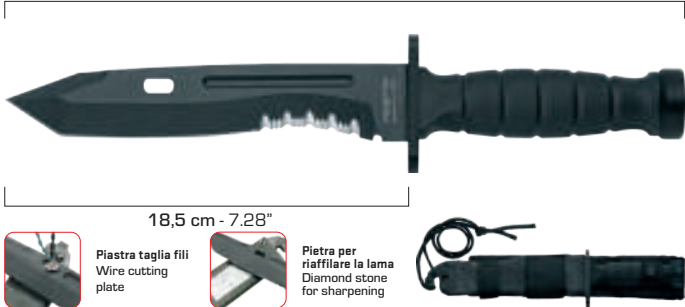

18,5 cm - 7.28"



Piastra taglia fili
Wire cutting
plate



**Pietra per
riaffilare la lama**
Diamond stone
for sharpening

N690Co

HRC 58-60

Black idroglider

5 mm - 0.20"

285 g - 10.05 oz



KRATON G nero
Black KRATON G
**Nylon® 1000D con sistema MOLLE e sede
in FRN® (Nylon® rinforzato con fibra di vetro)**
1000D Nylon® with MOLLE system and
FRN® (Fiberglass Reinforced Nylon®) sleeve



FOX OPLITA - BAYONET TANTO - LAMA FISSA/FIXED BLADE

FX-3003

31 cm - 12.20"

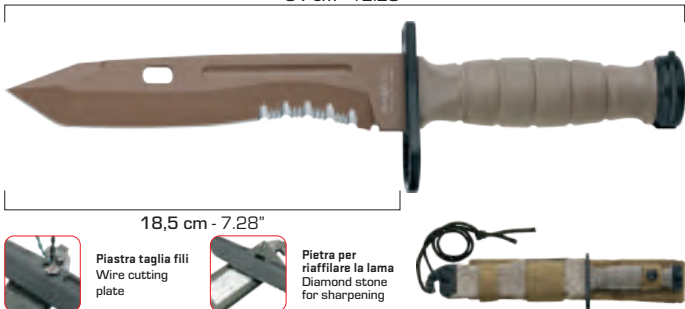

18,5 cm - 7.28"



Piastra taglia fili
Wire cutting
plate



**Pietra per
riaffilare la lama**
Diamond stone
for sharpening

N690Co

HRC 58-60

Coyote tan idroglider

5 mm - 0.20"

285 g - 10.05 oz



KRATON G coyote tan
Coyote tan KRATON G
**Nylon® 1000D con sistema MOLLE e sede
in FRN® (Nylon® rinforzato con fibra di vetro)**
1000D Nylon® with MOLLE system and
FRN® (Fiberglass Reinforced Nylon®) sleeve



FOX OPLITA - BAYONET TANTO - LAMA FISSA/FIXED BLADE

FX-3002

31 cm - 12.20"



18,5 cm - 7.28"



Piastra taglia fili
Wire cutting
plate



**Pietra per
riaffilare la lama**
Diamond stone
for sharpening

N690Co

HRC 58-60

Black idroglider

5 mm - 0.20"

285 g - 10.05 oz



KRATON G nero
Black KRATON G
**Nylon® 1000D con sistema MOLLE e sede
in FRN® (Nylon® rinforzato con fibra di vetro)**
1000D Nylon® with MOLLE system and
FRN® (Fiberglass Reinforced Nylon®) sleeve



PREDATOR I FIGHTING UTILITY KNIFE - LAMA FISSA/FIXED BLADE

FX-P1DC

27 cm - 10.62"



14 cm - 5.51"



N690Co



HRC 58-60



Black idroglider



6 mm - 0.24"



260 g - 9.17 oz



FORPRENE® nero
Black FORPRENE®



Acciaio inox AISI 304 rivestito al
Nichel



Nickel plated AISI 304 Stainless Steel



Nylon® 1000D con sistema MOLLE
Nylon® 1000D with MOLLE system

PREDATOR I FIGHTING UTILITY KNIFE - LAMA FISSA/FIXED BLADE

FX-P3B

27 cm - 10.62"

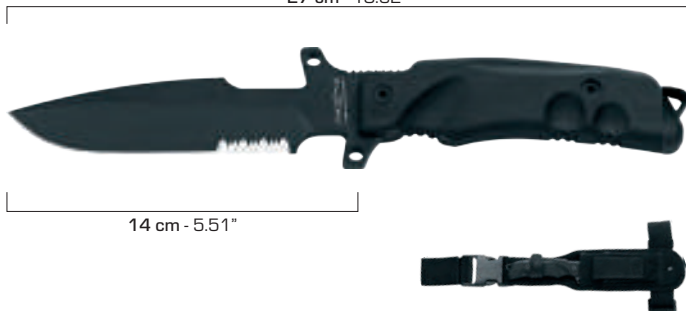

14 cm - 5.51"



N690Co



HRC 58-60



Black idroglider



6 mm - 0.24"



260 g - 9.17 oz



FORPRENE® nero
Black FORPRENE®



Acciaio inox AISI 304 rivestito al
Nichel



Nickel plated AISI 304 Stainless Steel



Nylon® 1000D con sistema MOLLE
Nylon® 1000D with MOLLE system

PREDATOR I FIGHTING UTILITY KNIFE - LAMA FISSA/FIXED BLADE

FX-G3B

30 cm - 11.81"

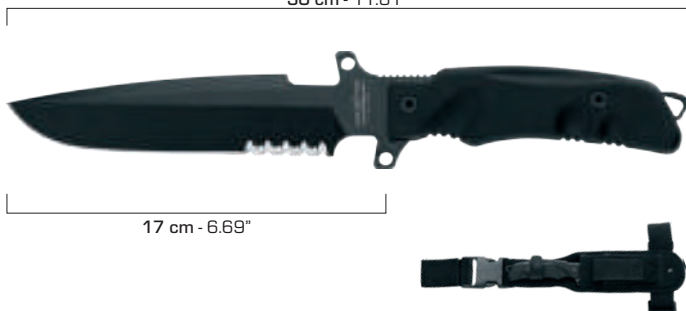

17 cm - 6.69"



N690Co



HRC 58-60



Black idroglider



6 mm - 0.24"



290 g - 10.22 oz



FORPRENE® nero
Black FORPRENE®



Acciaio inox AISI 304 rivestito al
Nichel



Nickel plated AISI 304 Stainless Steel



Nylon® 1000D con sistema MOLLE
Nylon® 1000D with MOLLE system

PREDATOR I FIGHTING UTILITY KNIFE - LAMA FISSA/FIXED BLADE

FX-G2DC

30 cm - 11.81"



17 cm - 6.69"



N690Co



HRC 58-60



Desert Camo idroglider



6 mm - 0.24"



295 g - 10.40 oz



FORPRENE® verde OD
OD green FORPRENE®



Acciaio inox AISI 304 rivestito al
Nichel



Nickel plated AISI 304 Stainless Steel



Nylon® 1000D con sistema MOLLE
Nylon® 1000D with MOLLE system

PREDATOR I FIGHTING UTILITY KNIFE - LAMA FISSA/FIXED BLADE

FX-G2B

30 cm - 11.81"



17 cm - 6.69"



N690Co



HRC 58-60



Black idroglider



6 mm - 0.24"



295 g - 10.40 oz



FORPRENE® nero
Black FORPRENE®



Acciaio inox AISI 304 rivestito al
Nichel



Nickel plated AISI 304 Stainless Steel



Nylon® 1000D con sistema MOLLE
Nylon® 1000D with MOLLE system

SPARTAN FOX - COMBAT KNIFE - LAMA FISSA/FIXED BLADE

SF-CC03

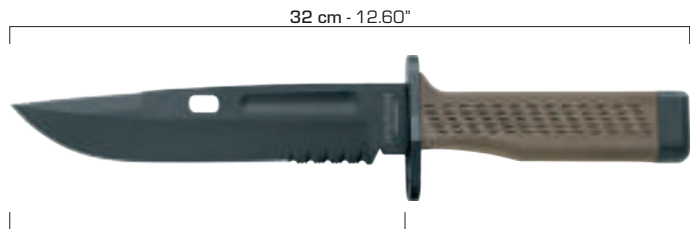

- N690Co
- HRC 58-60
- Mil Spec
- 6 mm - 0.24"
- 285 g - 10.05 oz

- FORPRENE® verde OD. Elsa AISI 420 coperto Mil Spec. OD green FORPRENE®. Black idrogliider AISI 420 pommel
- Nylon® 1000D con sistema MOLLE e sede in FRN® (Nylon® rinforzato con fibra di vetro) 1000D Nylon® with MOLLE system and FRN® (Fiberglass Reinforced Nylon®) sleeve

18,5 cm - 7.28"



Piastra taglia fili
Wire cutting plate



Pietra per
riaffilare la lama
Diamond stone
for sharpening



SPARTAN FOX DEFENDER - LAMA FISSA/FIXED BLADE

SF-DB03

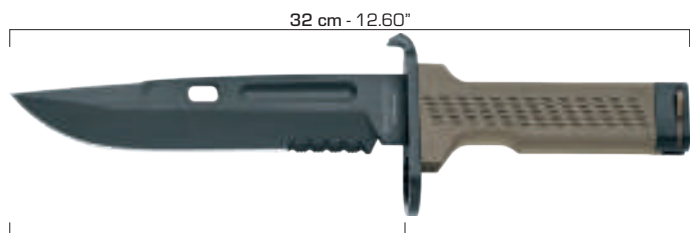

- N690Co
- HRC 58-60
- Mil Spec
- 6 mm - 0.24"
- 390 g - 13.75 oz

- FORPRENE® verde OD. Elsa AISI 420 black idrogliider. OD green FORPRENE®. Black idrogliider AISI 420 pommel
- Nylon® 1000D con sistema MOLLE e sede in FRN® (Nylon® rinforzato con fibra di vetro) 1000D Nylon® with MOLLE system and FRN® (Fiberglass Reinforced Nylon®) sleeve

18,5 cm - 7.28"



Piastra taglia fili
Wire cutting plate



Pietra per
riaffilare la lama
Diamond stone
for sharpening



SPARTAN FOX DEFENDER - LAMA FISSA/FIXED BLADE

FX-3004



- N690Co
- HRC 58-60
- Mil Spec
- 6 mm - 0.24"
- 460 g - 16.22 oz

- FORPRENE® nero. Elsa AISI 420 black idrogliider. Black FORPRENE®. Black idrogliider AISI 420 pommel
- Nylon® 1000D con sistema MOLLE e sede in FRN® (Nylon® rinforzato con fibra di vetro) 1000D Nylon® with MOLLE system and FRN® (Fiberglass Reinforced Nylon®) sleeve

20 cm - 7.87"



Piastra taglia fili
Wire cutting plate



Pietra per
riaffilare la lama
Diamond stone
for sharpening



FOX AREX SPARTAN BAYONET OFFICIAL SLOVENIAN ARMY VERSION - LAMA FISSA/FIXED BLADE

SF-F2000



- AISI 440C
- HRC 55-57
- Black idrogliider
- 5 mm - 0.20"
- 345 g - 12.16 oz

- FORPRENE® nero. Elsa AISI 420 black idrogliider. Black FORPRENE®. Black idrogliider AISI 420 pommel
- Nylon® 1000D con sistema MOLLE e sede in FRN® (Nylon® rinforzato con fibra di vetro) 1000D Nylon® with MOLLE system and FRN® (Fiberglass Reinforced Nylon®) sleeve

18,5 cm - 7.28"



Piastra taglia fili
Wire cutting plate



Pietra per
riaffilare la lama
Diamond stone
for sharpening



FOX AREX SPARTAN BAYONET OFFICIAL SLOVENIAN ARMY VERSION - LAMA FISSA/FIXED BLADE

SF-F2000 FN



- AISI 440C
- HRC 55-57
- Black idrogliider
- 5 mm - 0.20"
- 345 g - 12.16 oz

- FORPRENE® nero. Elsa AISI 420 black idrogliider. Black FORPRENE®. Black idrogliider AISI 420 pommel
- Nylon® 1000D con sistema MOLLE e sede in FRN® (Nylon® rinforzato con fibra di vetro) 1000D Nylon® with MOLLE system and FRN® (Fiberglass Reinforced Nylon®) sleeve





18,5 cm - 7.28"



Pietra per
riaffilare la lama
Diamond stone
for sharpening









SPECWOG WARRIOR COMBAT KNIFE by Dean Rostohar - LAMA FISSA/FIXED BLADE**FX-0171113**

-  **N690Co**
- HRC 58-60**
-  **PVD (Physical Vapor Deposition)**
-  **6 mm - 0.24"**
-  **335 g - 11.81 oz**





-  **G10 nero a trama grezza**
Coarse texture black G10
-  **Acciaio inox AISI 303 black idroglicer**
Black idroglicer AISI 303 Stainless Steel
-  **Kydex® con MOLLE - lock clip**
Kydex® with MOLLE - lock clip

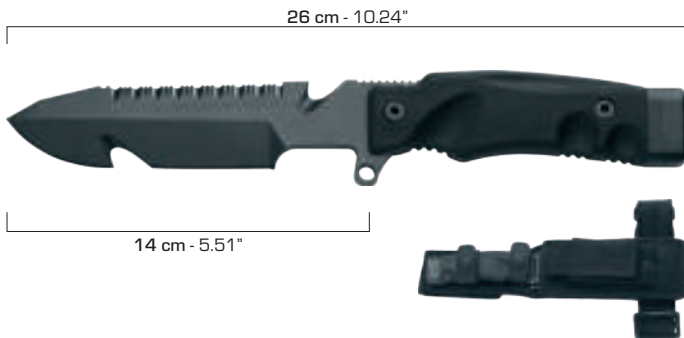

FOX TECNO MILITARY 3 - LAMA FISSA/FIXED BLADE**641/11FNK**

-  **N690Co**
- HRC 58-60**
-  **Black idroglicer**
-  **4 mm - 0.16"**
-  **165 g - 5.82 oz**

-  **PP + gomma sovrastampata, elsa in acciaio inox AISI 420 black idroglicer** - PP + over molding rubber, Black idroglicer AISI 420 pommel
-  **Nylon® con sistema MOLLE**
Nylon® with MOLLE system

FOX O.M.G. KAIMANO COMBAT DIVING KNIFE - LAMA FISSA/FIXED BLADE**OMG-1**

-  **N690Co**
- HRC 58-60**
-  **PVD (Physical Vapor Deposition)**
-  **6 mm - 0.24"**
-  **300 g - 10.58 oz**

-  **FORPRENE® nero. Elsa in acciaio inox AISI 420 black idroglicer**
Black FORPRENE®, Black idroglicer AISI 420 stainless steel pommel
-  **Acciaio inox AISI 304 rivestito al Nichel**
Nickel plated AISI 304 Stainless Steel
-  **Nylon® con sistema MOLLE**
Nylon® with MOLLE system







BlackFOX®

BlackFOX è una linea di prodotti delle **Coltellerie FOX** studiata attentamente per soddisfare le esigenze di chi pratica attività all'aperto come il campeggio, la pesca, la caccia, ma anche per chi si trova solo circondato dalla natura nelle condizioni più estreme.

Le caratteristiche che contraddistinguono questi coltelli sono: affidabilità, facilità d'uso ed il design innovativo ed ergonomico. Ogni minimo dettaglio delle lame e dei manici viene pensato e realizzato dagli specialisti del settore con grande precisione, utilizzando i migliori materiali disponibili.

BlackFOX è una valida scelta anche per gli operatori della sicurezza, del pronto intervento e delle forze dell'ordine. Si tratta di una linea dal design accattivante, ottimale per tutti coloro che vogliono praticare il loro lavoro o sport in piena sicurezza, ottenendo la massima performance.

Il marchio **BlackFOX** è garantito grazie alla quarantennale esperienza delle **Coltellerie FOX** nella produzione dei coltelli, dal 1977.

BlackFOX is a line of products from the **FOX Knives Company** that have been designed to meet the needs of those who practice outdoor activities, such as camping, fishing and hunting.

Reliability, ease of use, innovative and ergonomic design: these are the main features of **BlackFOX** knives. Every single detail of blades and handles is designed and realized by specialists, with particular accuracy, using the best materials available.

BlackFOX is an excellent choice also for professional people like rescue teams, fire fighters, police and law enforcement. It is a perfect line for those who want to work or do sport safely and getting the best performance.

The **BlackFOX** brand is guaranteed thanks to the 40 years experience of the **FOX Knives Company**, since 1977.





COLTELLI CHIUDIBILI BLACKFOX BLACKFOX FOLDING KNIVES

Coltelli chiudibili dal design mai banale, che accompagnano nei compiti di ogni giorno. Pensati per accontentare chi ricerca in un coltello qualità ed abbordabilità, senza compromettere la capacità operativa dello strumento.





Folding knives with a never boring design, that accompany in everyday tasks. Designed to satisfy those looking for quality and affordability in a knife, without compromising the operational capacity of the tool.





NEW!

CIOL by Denis Simonutti - SLIP JOINT

BF-748 CR



-  AISI 440C
- HRC** 57-59
-  PVD Stone washed
-  2,5 mm - 0.09"
-  100 g - 3.52 oz

-  **Rame stone washed**
Stone washed copper
-  **Acciaio inox AISI 420 lucido**
Polished AISI 420 Stainless Steel
-  **Acciaio inox AISI 416 black idrogliider**
Black idrogliider AISI 416 Stainless Steel
-  **Cuoio**
Leather

NEW!

CIOL by Denis Simonutti - SLIP JOINT

BF-748 ZW



-  AISI 440C
- HRC** 57-59
-  Satinata
Satin
-  2,5 mm - 0.09"
-  70 g - 2.46 oz

-  **Legno di Zebrawood**
Zebrawood
-  **Acciaio inox AISI 420 lucido**
Polished AISI 420 Stainless Steel
-  **Acciaio inox AISI 416 lucido**
Polished AISI 416 Stainless Steel
-  **Cuoio**
Leather

NEW!

CIOL by Denis Simonutti - SLIP JOINT

BF-748 MI



-  AISI 440C
- HRC** 57-59
-  Stone washed
-  2,5 mm - 0.09"
-  45 g - 1.58 oz

-  **Micarta verde OD**
OD green Canvas Micarta
-  **Acciaio inox AISI 420 lucido**
Polished AISI 420 Stainless Steel
-  **Acciaio inox AISI 416 lucido**
Polished AISI 416 Stainless Steel
-  **Cuoio**
Leather

NEW!

CIOL by Denis Simonutti - SLIP JOINT

BF-748 MIB



-  AISI 440C
- HRC** 57-59
-  Stone washed
-  2,5 mm - 0.09"
-  45 g - 1.58 oz





-  **Micarta marrone**
Brown Canvas Micarta
-  **Acciaio inox AISI 420 lucido**
Polished AISI 420 Stainless Steel
-  **Acciaio inox AISI 416 lucido**
Polished AISI 416 Stainless Steel
-  **Cuoio**
Leather

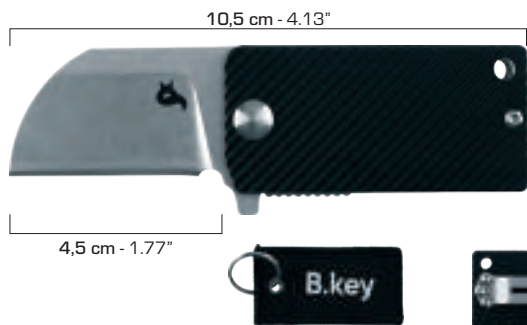

NEW!

B.KEY by Beric Design - LINER LOCK

BF-750



-  AISI 440A
- HRC** 57-59
-  Stone washed
-  4 mm - 0.15"
-  70 g - 2.46 oz
-  **Alluminio anodizzato nero**
Black anodized Aluminium

-  **Acciaio inox AISI 420**
AISI 420 Stainless Steel
-  **Acciaio inox AISI 420 stone washed**
Stone washed 420 Stainless Steel
-  **Acciaio inox AISI 420 lucido**
Polished AISI 420 Stainless Steel
-  **Acciaio inox AISI 416 lucido**
Polished AISI 416 Stainless Steel

NEW!

B.KEY by Beric Design - LINER LOCK

BF-750 OD

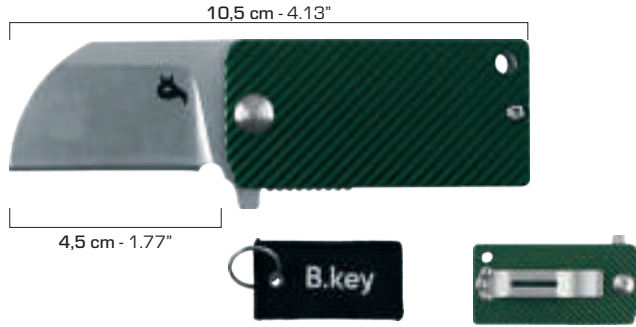

- AISI 440A
- HRC** 57-59
- Stone washed
- 4 mm - 0.15"
- 70 g - 2.46 oz
- Alluminio anodizzato verde OD
OD green anodized Aluminium

- Acciaio inox AISI 420**
AISI 420 Stainless Steel
- Acciaio inox AISI 420 stone washed**
Stone washed 420 Stainless Steel
- Acciaio inox AISI 420 lucido**
Polished AISI 420 Stainless Steel
- Acciaio inox AISI 416 lucido**
Polished AISI 416 Stainless Steel

NEW!

B.KEY by Beric Design - LINER LOCK

BF-750 BL



- AISI 440A
- HRC** 57-59
- Stone washed
- 4 mm - 0.15"
- 70 g - 2.46 oz
- Alluminio anodizzato blu
Blue anodized Aluminium

- Acciaio inox AISI 420**
AISI 420 Stainless Steel
- Acciaio inox AISI 420 stone washed**
Stone washed 420 Stainless Steel
- Acciaio inox AISI 420 lucido**
Polished AISI 420 Stainless Steel
- Acciaio inox AISI 416 lucido**
Polished AISI 416 Stainless Steel

NEW!

O.KEY by Beric Design - LINER LOCK

BF-751

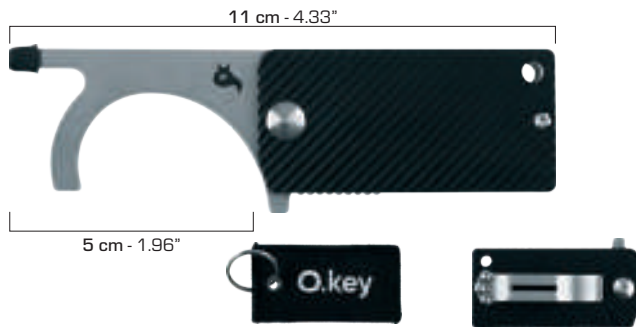

- AISI 440A
- HRC** 57-59
- Stone washed
- 4 mm - 0.15"
- 70 g - 2.46 oz
- Alluminio anodizzato nero
Black anodized Aluminium

- Acciaio inox AISI 420**
AISI 420 Stainless Steel
- Acciaio inox AISI 420 stone washed**
Stone washed 420 Stainless Steel
- Acciaio inox AISI 420 lucido**
Polished AISI 420 Stainless Steel
- Acciaio inox AISI 416 lucido**
Polished AISI 416 Stainless Steel

NEW!

O.KEY by Beric Design - LINER LOCK

BF-751 O

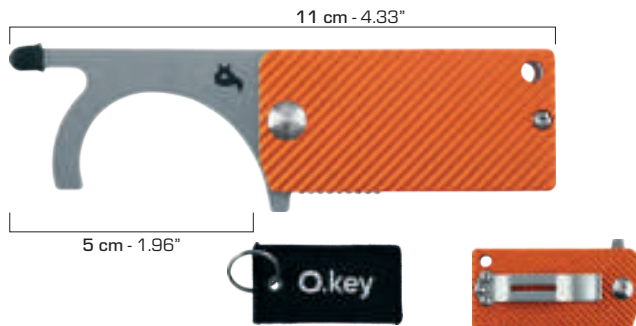

- AISI 440A
- HRC** 57-59
- Stone washed
- 4 mm - 0.15"
- 70 g - 2.46 oz
- Alluminio anodizzato arancio
Orange anodized Aluminium

- Acciaio inox AISI 420**
AISI 420 Stainless Steel
- Acciaio inox AISI 420 stone washed**
Stone washed 420 Stainless Steel
- Acciaio inox AISI 420 lucido**
Polished AISI 420 Stainless Steel
- Acciaio inox AISI 416 lucido**
Polished AISI 416 Stainless Steel

NEW!

O.KEY by Beric Design - LINER LOCK

BF-751 BL

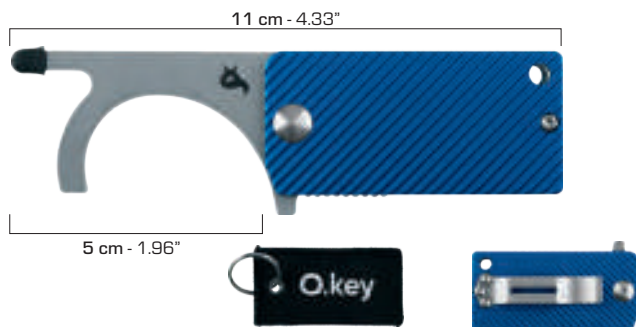

- AISI 440A
- HRC** 57-59
- Stone washed
- 4 mm - 0.15"
- 70 g - 2.46 oz
- Alluminio anodizzato blu
Blue anodized Aluminium





- Acciaio inox AISI 420**
AISI 420 Stainless Steel
- Acciaio inox AISI 420 stone washed**
Stone washed 420 Stainless Steel
- Acciaio inox AISI 420 lucido**
Polished AISI 420 Stainless Steel
- Acciaio inox AISI 416 lucido**
Polished AISI 416 Stainless Steel

NEW!

KIT - FRAME LOCK

BF-752



-  **AISI 440C**
- HRC 57-59**
-  **Stone washed**
-  **3 mm - 0.12"**
-  **70 g - 2.46 oz**





-  **G10 nero a trama fine**
Fine texture black G10
-  **Acciaio inox AISI 420 stone washed**
Stone washed AISI 420 Stainless Steel
-  **Acciaio inox AISI 420 lucido**
Polished AISI 420 Stainless Steel
-  **Acciaio inox AISI 420 lucido**
Polished AISI 420 Stainless Steel
-  **Acciaio inox AISI 216 lucido**
Polished AISI 216 Stainless Steel





NEW!

KIT - FRAME LOCK

BF-752 OD



-  **AISI 440C**
- HRC 57-59**
-  **Stone washed**
-  **3 mm - 0.12"**
-  **70 g - 2.46 oz**

-  **G10 verde OD a trama fine**
Fine texture OD green G10
-  **Acciaio inox AISI 420 stone washed**
Stone washed AISI 420 Stainless Steel
-  **Acciaio inox AISI 420 lucido**
Polished AISI 420 Stainless Steel
-  **Acciaio inox AISI 420 lucido**
Polished AISI 420 Stainless Steel
-  **Acciaio inox AISI 216 lucido**
Polished AISI 216 Stainless Steel

NEW!

REVOLVER - LINER LOCK

BF-7400D





-  **D2**
- HRC 59-60**
-  **Satinata**
Satin
-  **4 mm - 0.16"**
-  **125 g - 4.40 oz**





-  **Micarta verde OD**
OD green Canvas Micarta
-  **Acciaio inox AISI 420 lucido**
Polished AISI 420 Stainless Steel
-  **Acciaio inox AISI 420 lucido**
Polished AISI 420 Stainless Steel
-  **G10 nero**
Back G10
-  **Acciaio inox AISI 216 lucido**
Polished AISI 216 Stainless Steel

REVOLVER - LINER LOCK

BF-740



-  **AISI 440C**
- HRC 57-59**
-  **Satinata**
Satin
-  **4 mm - 0.16"**
-  **80 g - 2.82 oz**

-  **G10 nero a trama fine**
Fine texture black G10
-  **Acciaio inox AISI 420 lucido**
Polished AISI 420 Stainless Steel
-  **Acciaio inox AISI 420 lucido**
Polished AISI 420 Stainless Steel
-  **G10 nero**
Black G10
-  **Acciaio inox AISI 216 lucido**
Polished AISI 216 Stainless Steel

NIDHUG by Mikkel Wilumsen - SLIP JOINT

BF-7140R



-  **AISI 440A**
- HRC 55-57**
-  **Satinata**
Satin
-  **3 mm - 0.12"**
-  **120 g - 4.23 oz**

-  **G10 arancione a trama fine**
Fine texture orange G10
-  **Acciaio inox AISI 420 lucido**
Polished AISI 420 Stainless Steel
-  **Acciaio inox AISI 420J2B lucido**
Polished AISI 420J2B Stainless Steel
-  **Acciaio inox AISI 420 lucido**
Polished AISI 420 Stainless Steel
-  **Acciaio inox AISI 416 lucido**
Polished AISI 416 Stainless Steel

NEW!

BEAN GEN2 by Serge Panchenko - SLIP JOINT

BF-719 MI

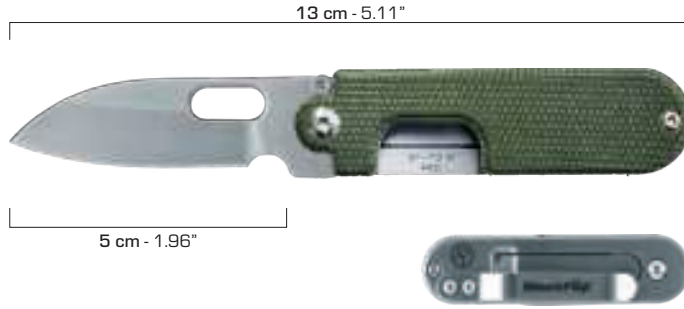

-  **AISI 440C**
- HRC 57-59**
-  **Satinata**
Satin
-  **3 mm - 0.14"**
-  **65 g - 2.29 oz**





-  **Micarta verde OD**
OD green Canvas Micarta
-  **Acciaio inox AISI 420 satinato**
Satin AISI 420 Stainless Steel
-  **Acciaio inox AISI 420J2B**
AISI 420J2B Stainless Steel
-  **Acciaio inox AISI 416 lucido**
Polished AISI 416 Stainless Steel

NEW!

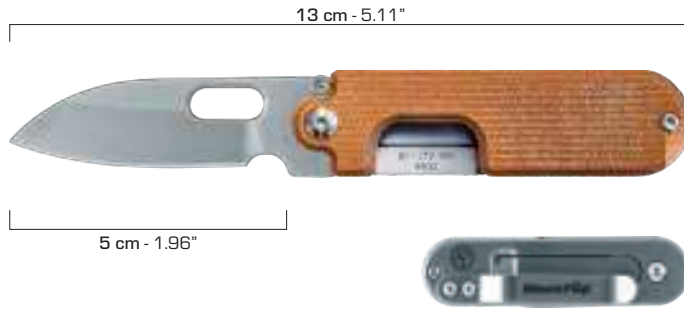
BEAN GEN2 by Serge Panchenko - SLIP JOINT

BF-719 MIN







-  **AISI 440C**
- HRC 57-59**
-  **Satinata**
Satin
-  **3 mm - 0.14"**
-  **65 g - 2.29 oz**



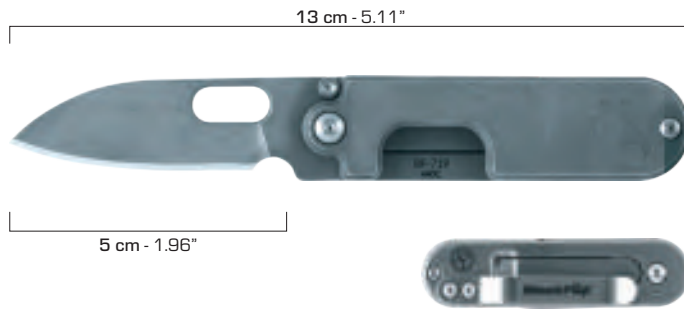

-  **Micarta naturale**
Natural Canvas Micarta
-  **Acciaio inox AISI 420 satinato**
Satin AISI 420 Stainless Steel
-  **Acciaio inox AISI 420J2B**
AISI 420J2B Stainless Steel
-  **Acciaio inox AISI 416 lucido**
Polished AISI 416 Stainless Steel

BEAN GEN2 by Serge Panchenko - SLIP JOINT

BF-719







-  **AISI 440C**
- HRC 57-59**
-  **Stone washed**
-  **3 mm - 0.14"**
-  **65 g - 2.29 oz**

-  **Acciaio inox stone washed**
Stone washed Stainless Steel
-  **Acciaio inox AISI 420 satinato**
Satin AISI 420 Stainless Steel
-  **Acciaio inox AISI 420J2B lucido**
Polished AISI 420J2B Stainless Steel
-  **Acciaio inox AISI 416 lucido**
Polished AISI 416 Stainless Steel

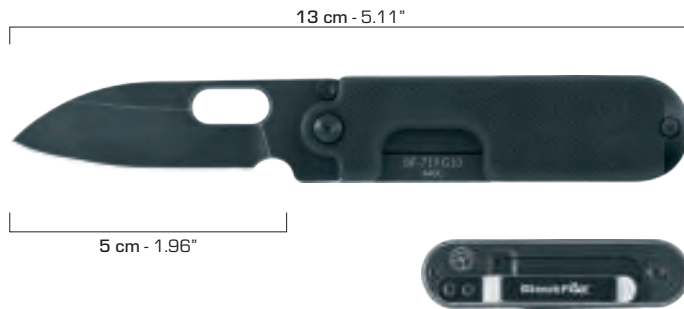
BEAN GEN2 by Serge Panchenko - SLIP JOINT

BF-719 G10



-  **AISI 440C**
- HRC 57-59**
-  **Black idrogliker stone washed**
-  **3 mm - 0.14"**
-  **60 g - 2.11 oz**



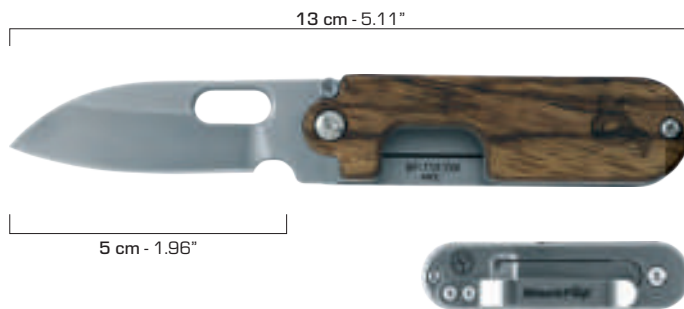

-  **G10 nero a trama fine**
Fine texture Black G10
-  **Acciaio inox AISI 420 black idrogliker stone washed** - Black idrogliker AISI 420 Stainless Steel
-  **Acciaio inox AISI 420J2B black idrogliker stone washed** - Black idrogliker AISI 420J2B Stainless Steel
-  **Acciaio inox AISI 416 black idrogliker**
Black idrogliker AISI 416 Stainless Steel

BEAN GEN2 by Serge Panchenko - SLIP JOINT

BF-719 ZW



-  **AISI 440C**
- HRC 57-59**
-  **Satinata**
Satin
-  **3 mm - 0.14"**
-  **65 g - 2.29 oz**

-  **Legno di Zebrano**
Zebra wood
-  **Acciaio inox AISI 420 satinato**
Satin AISI 420 Stainless Steel
-  **Acciaio inox AISI 420J2B lucido**
Polished AISI 420J2B Stainless Steel
-  **Acciaio inox AISI 416 lucido**
Polished AISI 416 Stainless Steel

RELOADED - LINER LOCK

BF-736

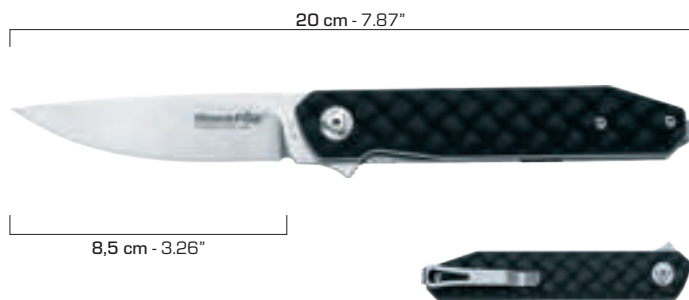

AISI 440C

HRC 57-59

Stone washed con arrotatura satinata
Stone washed with satin blade grind

3 mm - 0.12"

70 g - 2.46 oz



G10 nero lavorato in 3D
3D machined black G10



Acciaio inox AISI 420 stone washed
Stone washed AISI 420 Stainless Steel



Acciaio inox AISI 420J2B lucido
Polished AISI 420J2B Stainless Steel



G10 nero
Black G10



Acciaio inox AISI 416 lucido
Polished AISI 416 Stainless Steel

RELOADED - LINER LOCK

BF-736 TI

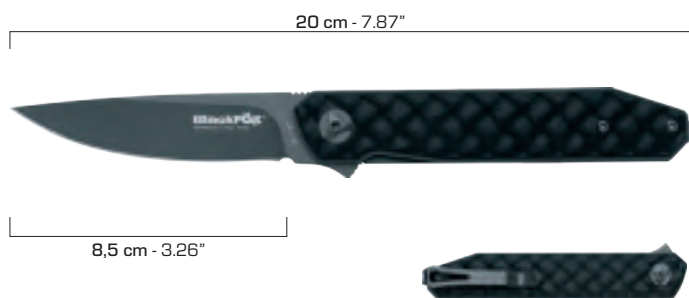

AISI 440C

HRC 57-59

PVD (Physical Vapor Deposition)

3 mm - 0.12"

70 g - 2.46 oz



G10 nero lavorato in 3D
3D machined black G10



Acciaio inox AISI 420 PVD
PVD AISI 420 Stainless Steel



Acciaio inox AISI 420 PVD
PVD AISI 420 Stainless Steel



G10 nero
Black G10



Acciaio inox AISI 416 black idrogliider
Black idrogliider AISI 416 Stainless Steel

RED ACTION - LINER LOCK

BF-737



AISI 440C

HRC 57-59

Satinata
Satin

3,5 mm - 0.14"

110 g - 3.88 oz

G10 rosso a trama fine
Fine texture Red G10



Acciaio inox AISI 420 lucido
Polished AISI 420 Stainless Steel



Acciaio inox AISI 420J2B lucido
Polished AISI 420J2B Stainless Steel



Acciaio inox AISI 420 temprato
Tempered AISI 420 Stainless Steel



Acciaio inox AISI 420 sabbiato
Bead blasted AISI 420 Stainless Steel



Acciaio inox AISI 416 lucido
Polished AISI 416 Stainless Steel



Nylon® 1000D

BLACK ACTION - LINER LOCK

BF-738TI



AISI 440C

HRC 57-59

PVD (Physical Vapor Deposition)

3,5 mm - 0.14"

110 g - 3.88 oz

G10 nero a trama fine
Fine texture black G10



Acciaio inox AISI 420 PVD
PVD AISI 420 Stainless Steel



Acciaio inox AISI 420J2B PVD
PVD AISI 420J2B Stainless Steel



Acciaio inox AISI 420 temprato PVD
Tempered PVD AISI 420 Stainless Steel



Acciaio inox AISI 420 PVD
PVD AISI 420 Stainless Steel



Acciaio inox AISI 416 black idrogliider
Black idrogliider AISI 416 Stainless Steel



Nylon® 1000D

JIMSON - LINER LOCK

BF-743

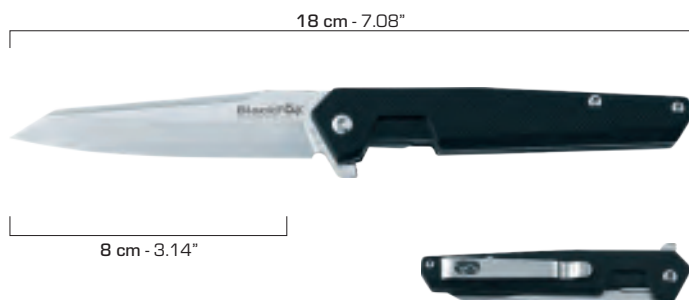

AISI 440C

HRC 57-59

Satinata
Satin

3 mm - 0.12"

67 g - 2.36 oz



G10 nero a trama fine
Fine texture black G10



Acciaio inox AISI 420 lucido
Polished AISI 420 Stainless Steel



Acciaio inox AISI 420 lucido
Polished AISI 420 Stainless Steel



G10 nero
Black G10







Acciaio inox AISI 216 lucido
Polished AISI 216 Stainless Steel

METROPOLIS - LINER LOCK

BF-739







-  AISI 440C
- HRC** 57-59
-  Satinata
Satin
-  3,5 mm - 0.14"
-  70 g - 2.46 oz





-  **G10 nero a trama fine**
Fine texture black G10
-  **Acciaio inox AISI 420 lucido**
Polished AISI 420 Stainless Steel
-  **Acciaio inox AISI 420J2B lucido**
Polished AISI 420J2B Stainless Steel
-  **G10 nero**
Black G10
-  **Acciaio inox AISI 416 lucido**
Polished AISI 416 Stainless Steel

METROPOLIS - LINER LOCK

BF-739T1







-  440C
- HRC** 57-59
-  PVD (Physical Vapor Deposition)
-  3,5 mm - 0.14"
-  70 g - 2.46 oz



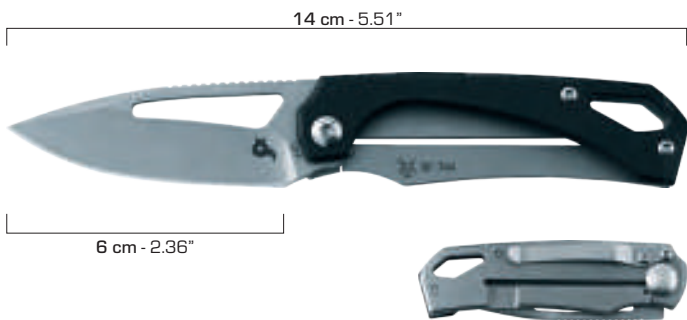

-  **G10 nero a trama fine**
Fine texture black G10
-  **Acciaio inox AISI 420 PVD**
PVD AISI 420 Stainless Steel
-  **Acciaio inox AISI 420J2B PVD**
PVD AISI 420J2B Stainless Steel
-  **G10 nero**
Black G10
-  **Acciaio inox AISI 416 black idrogliider**
Black idrogliider AISI 416 Stainless Steel

RACLI by Denis Simonutti - FRAME LOCK

BF-744





-  AISI 440C
- HRC** 57-59
-  Stone washed
-  3 mm - 0.12"
-  44 g - 1.55 oz





-  **G10 nero a trama fine**
Fine texture black G10
-  **Acciaio inox AISI 440C stone washed**
Stone washed AISI 440C Stainless Steel
-  **Acciaio inox AISI 420J2B stone washed**
Stone washed AISI 420J2B Stainless Steel
-  **G10 nero**
Black G10
-  **Acciaio inox AISI 416 lucido**
Polished AISI 416 Stainless Steel

RACLI by Denis Simonutti - FRAME LOCK

BF-744 ZW







-  AISI 440C
- HRC** 57-59
-  Satinata
Satin
-  3 mm - 0.12"
-  44 g - 1.55 oz

-  **Legno di Zebrawood**
Zebrawood
-  **Acciaio inox AISI 440C satinato**
Satin AISI 440C Stainless Steel
-  **Acciaio inox AISI 420J2B satinato**
Satin AISI 420J2B Stainless Steel
-  **Legno di Zebrawood**
Zebrawood
-  **Acciaio inox AISI 416 lucido**
Polished AISI 416 Stainless Steel

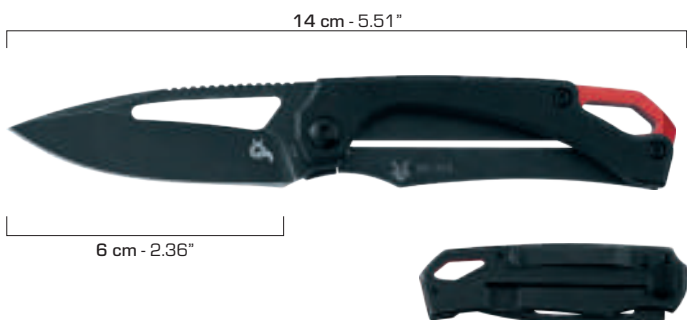
RACLI by Denis Simonutti - FRAME LOCK





BF-745



-  AISI 440C
- HRC** 57-59
-  Black idrogliider stone washed
-  3 mm - 0.12"
-  48 g - 1.69 oz

-  **G10 nero a trama fine**
Fine texture black G10
-  **Acciaio inox AISI 420J2B PVD stone washed**
PVD stone washed AISI 420J2B Stainless Steel
-  **Acciaio inox AISI 420J2B PVD stone washed**
PVD stone washed AISI 420J2B Stainless Steel
-  **Alluminio anodizzato rosso**
Red anodized aluminum
-  **Acciaio inox AISI 416 black idrogliider**
Black idrogliider AISI 416 Stainless Steel





BALISONG - MAGNETIC LATCH**BF-500**

-  **AISI 440A**
- HRC 55-57**
-  **PVD (Physical Vapor Deposition)**
-  **3 mm - 0.12"**
-  **190 g - 6.70 oz**

-  **G10 nero sagomato con inserto rosso**
Black contoured G10 with red insert
-  **Acciaio inox AISI 420J2B PVD**
PVD AISI 420J2B Stainless Steel
-  **Acciaio inox AISI 420 PVD**
PVD AISI 420 Stainless Steel
-  **Acciaio inox AISI 416 black idrogliider**
Black idrogliider AISI 416 Stainless Steel

BALISONG - MAGNETIC LATCH**BF-501**

-  **AISI 440A**
- HRC 55-57**
-  **Satinata**
Satin
-  **3 mm - 0.12"**
-  **190 g - 6.70 oz**

-  **G10 nero sagomato con inserto rosso**
Black contoured G10 with red insert
-  **Acciaio inox AISI 420J2B lucido**
Polished AISI 420J2B Stainless Steel
-  **Acciaio inox AISI 420 sabbato**
Bead blasted AISI 420 Stainless Steel
-  **Acciaio inox AISI 416 lucido**
Polished AISI 416 Stainless Steel

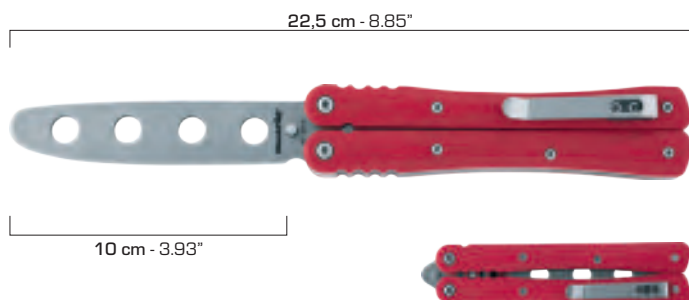
BALISONG training version - MAGNETIC LATCH**BF-501 TK**

-  **AISI 440A**
- HRC 55-57**
-  **Stone washed**
-  **3 mm - 0.12"**
-  **205 g - 7.23 oz**



-  **G10 rosso sagomato con inserto arancione**
Contoured red G10 with orange insert
-  **Acciaio inox AISI 420J2B lucido**
Polished AISI 420J2B Stainless Steel
-  **Acciaio inox AISI 420 sabbato**
Bead blasted AISI 420 Stainless Steel
-  **Acciaio inox AISI 416 lucido**
Polished AISI 416 Stainless Steel

KRAVI SHAI by Avi Nardia - LINER LOCK**BF-729**

-  **AISI 440C**
- HRC 57-59**
-  **PVD stone washed**
-  **2,5 mm - 0.08"**
-  **75 g - 2.64 oz**

-  **G10 nero a trama fine**
Fine texture black G10
-  **Acciaio inox AISI 420 black idrogliider**
Black idrogliider AISI 420 Stainless Steel
-  **Acciaio inox AISI 420J2B black idrogliider**
Black idrogliider AISI 420J2B Stainless Steel
-  **Acciaio inox AISI 420 black idrogliider**
Black idrogliider AISI 420 Stainless Steel
-  **Acciaio inox AISI 416 lucido**
Polished AISI 416 Stainless Steel

KRAVI SHAI by Avi Nardia - LINER LOCK**BF-729 SW**





-  **AISI 440C**
- HRC 57-59**
-  **Stone washed**
-  **2,5 mm - 0.08"**
-  **75 g - 2.64 oz**



-  **G10 verde OD a trama fine**
Fine texture OD green G10
-  **Acciaio inox AISI 420 stone washed**
Stone washed AISI 420 Stainless Steel
-  **Acciaio inox AISI 420J2B stone washed**
Stone washed AISI 420J2B Stainless Steel
-  **Acciaio inox AISI 420 satinato**
Satind AISI 420 Stainless Steel
-  **Acciaio inox AISI 416 lucido**
Polished AISI 416 Stainless Steel

MUNIN by Mikkel Willumsen - LINER LOCK

BF-747







-  AISI 440C
- HRC** 57-59
-  Black idrogliker stone washed
-  3,5 mm - 0.14"
-  125 g - 2.36 oz





-  **G10 nero a trama fine**
Fine texture black G10
-  **Acciaio inox AISI 420 black idrogliker**
Black idrogliker AISI 420 Stainless Steel
-  **Acciaio inox AISI 420J2B black idrogliker**
Black idrogliker AISI 420J2B Stainless Steel
-  **Acciaio inox AISI 420 black idrogliker**
Black idrogliker AISI 420 Stainless Steel
-  **Acciaio inox AISI 416 black idrogliker**
Black idrogliker AISI 416 Stainless Steel

ECHO 1 by Mikkel Willumsen - LINER LOCK

BF-746







-  AISI 440C
- HRC** 57-59
-  Black idrogliker stone washed
-  3,5 mm - 0.14"
-  135 g - 4.76 oz





-  **G10 nero a trama fine**
Fine texture black G10
-  **Acciaio inox AISI 420 black idrogliker**
Black idrogliker AISI 420 Stainless Steel
-  **Acciaio inox AISI 420J2B black idrogliker**
Black idrogliker AISI 420J2B Stainless Steel
-  **G10 nero**
Black G10
-  **Acciaio inox AISI 416 black idrogliker**
Black idrogliker AISI 416 Stainless Steel

ECHO 1 by Mikkel Willumsen - LINER LOCK

BF-746 OD







-  AISI 440C
- HRC** 57-59
-  Stone washed
-  3,5 mm - 0.14"
-  135 g - 4.76 oz





-  **G10 verde OD a trama fine**
Fine texture OD green G10
-  **Acciaio inox AISI 420 stone washed**
Stone washed AISI 420 Stainless Steel
-  **Acciaio inox AISI 420J2B stone washed**
Stone washed AISI 420J2B Stainless Steel
-  **G10 verde OD**
OD green G10
-  **Acciaio inox AISI 416 lucido**
Polished AISI 416 Stainless Steel

HUGIN by Mikkel Willumsen- LINER LOCK

BF-721







-  AISI 440C
- HRC** 57-59
-  PVD stone washed
-  4 mm - 0.16"
-  180 g - 6.34 oz
-  **G10 nero a trama fine**
Fine texture black G10





-  **Acciaio inox AISI 420 PVD stone washed**
PVD stone washed AISI 420 Stainless Steel
-  **Acciaio inox AISI 420J2B PVD stone washed**
PVD stone washed AISI 420J2B Stainless Steel
-  **Acciaio inox AISI 420 PVD stone washed**
PVD stone washed AISI 420 Stainless Steel
-  **Acciaio inox AISI 416 black idrogliker**
Black idrogliker AISI 416 Stainless Steel
-  **Movimento con cuscinetti a sfere**
Ball Bearing operating system

HUGIN by Mikkel Willumsen- LINER LOCK

BF-721 G



-  AISI 440C
- HRC** 57-59
-  PVD stone washed
-  4 mm - 0.16"
-  180 g - 6.34 oz
-  **G10 verde OD a trama fine**
Fine texture OD green G10

-  **Acciaio inox AISI 420 PVD stone washed**
PVD stone washed AISI 420 Stainless Steel
-  **Acciaio inox AISI 420J2B PVD stone washed**
PVD stone washed AISI 420J2B Stainless Steel
-  **Acciaio inox AISI 420 PVD stone washed**
PVD stone washed AISI 420 Stainless Steel
-  **Acciaio inox AISI 416 black idrogliker**
Black idrogliker AISI 416 Stainless Steel
-  **Movimento con cuscinetti a sfere**
Ball Bearing operating system

SKÅL by Denis Simonutti - FRICTION FOLDER

BF-732







-  AISI 440C
-  HRC 57-59
-  Stone washed
-  3 mm - 0.12"
-  40 g - 1.41 oz

-  **G10 nero lavorato in 3D**
3D machined black G10
-  **Acciaio inox AISI 420 lucido**
Polished AISI 420 Stainless Steel
-  **Acciaio inox AISI 416 lucido**
Polished AISI 416 Stainless Steel
-  **Kydex®**

SKÅL by Denis Simonutti - FRICTION FOLDER

BF-732G



-  AISI 440C
-  HRC 57-59
-  Stone washed
-  3 mm - 0.12"
-  40 g - 1.41 oz





-  **G10 verde lavorato in 3D**
3D machined green G10
-  **Acciaio inox AISI 420 lucido**
Polished AISI 420 Stainless Steel
-  **Acciaio inox AISI 416 lucido**
Polished AISI 416 Stainless Steel
-  **Kydex®**

KUMA by Antonio Di Gennaro - BACK LOCK

BF-704









-  AISI 440C
-  HRC 57-59
-  PVD (Physical Vapor Deposition)
-  4 mm - 0.16"
-  220 g - 7.76 oz
-  **G10 nero sagomato**
Contoured black G10

-  **Acciaio inox AISI 420 black idrogliider**
Black idrogliider AISI 420 Stainless Steel
-  **Acciaio inox AISI 420J2B black idrogliider**
Black idrogliider AISI 420J2B Stainless Steel
-  **Acciaio inox AISI 420 black idrogliider**
Black idrogliider AISI 420 Stainless Steel
-  **Acciaio inox AISI 416 black idrogliider**
Black idrogliider AISI 416 Stainless Steel
-  **Nylon® 1000D**

SAI - LINER LOCK

BF-705T





-  AISI 440C
-  HRC 57-59
-  PVD (Physical Vapor Deposition)
-  4 mm - 0.16"
-  165 g - 5.82 oz
-  **G10 coyote tan a trama fine**
Fine texture coyote tan G10

-  **Acciaio inox AISI 420 lucido**
Polished AISI 420 Stainless Steel
-  **Acciaio inox AISI 420J2B black idrogliider**
Black idrogliider AISI 420J2B Stainless Steel
-  **Acciaio inox AISI 416 PVD**
PVD AISI 416 Stainless Steel
-  **Acciaio inox AISI 420 lucido**
Polished AISI 420 Stainless Steel
-  **Acciaio inox AISI 416 black idrogliider**
Black idrogliider AISI 416 Stainless Steel

LINER LOCK

BF-91



-  AISI 440A
-  HRC 55-57
-  **Satinata**
Satin
-  3 mm - 0.12"
-  60 g - 2.11 oz



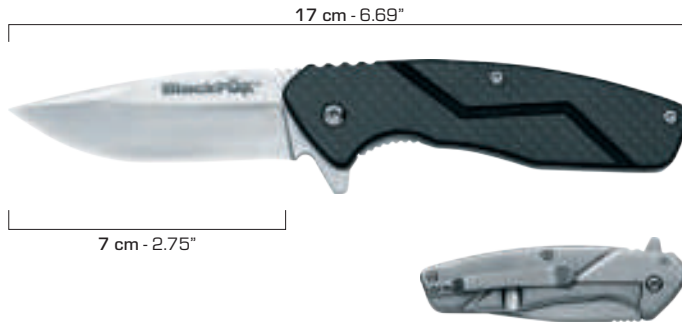

-  **Zytel nero a grana fine**
Fine texture Black Zytel
-  **Acciaio inox AISI 420 lucido**
Polished AISI 420 Stainless Steel
-  **Acciaio inox AISI 420J2B lucido**
Polished AISI 420J2B Stainless Steel
-  **Acciaio inox AISI 420 lucido**
Polished AISI 420 Stainless Steel
-  **Acciaio inox AISI 416 lucido**
Polished AISI 416 Stainless Steel

CARBONIX - FRAME LOCK

BF-716



-  AISI 440C
- HRC** 57-59
-  Satinata
Satin
-  3 mm - 0.12"
-  105 g - 3.70 oz



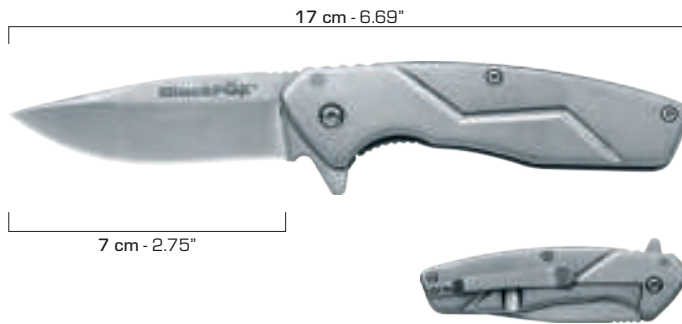

-  **Fibra di Carbonio**
Carbon fiber
-  **Acciaio inox AISI 420 stone washed**
Stone washed AISI 420 Stainless Steel
-  **Acciaio inox AISI 420J2B stone washed**
Stone washed AISI 420J2B Stainless Steel
-  **Acciaio inox AISI 420 sabbato**
Bead blasted AISI 420 Stainless Steel
-  **Acciaio inox AISI 416 lucido**
Polished AISI 416 Stainless Steel

STEELIX - FRAME LOCK

BF-717







-  AISI 440C
- HRC** 57-59
-  Stone washed
-  3 mm - 0.12"
-  110 g - 3.88 oz



-  **Acciaio inox AISI 420 stone washed**
Stone washed AISI 420 Stainless Steel
-  **Acciaio inox AISI 420 stone washed**
Stone washed AISI 420 Stainless Steel
-  **Acciaio inox AISI 420J2B**
AISI 420J2B Stainless Steel
-  **Acciaio inox AISI 420 sabbato**
Bead blasted AISI 420 Stainless Steel
-  **Acciaio inox AISI 416 lucido**
Polished AISI 416 Stainless Steel

FRAME LOCK

BF-434G10



-  440A
- HRC** 55-57
-  PVD (Physical Vapor Deposition)
-  2 mm - 0.08"
-  45 g - 1.58 oz



-  **G10 nero a trama fine**
Fine texture black G10
-  **Acciaio inox AISI 420 PVD**
PVD AISI 420 Stainless Steel
-  **Acciaio inox AISI 420J2B PVD**
PVD AISI 420J2B Stainless Steel
-  **G10 nero**
Black G10
-  **Acciaio inox AISI 416 PVD**
PVD AISI 416 Stainless Steel

FRAME LOCK

BF-434ZW



-  AISI 440A
- HRC** 55-57
-  Satinata
Satin
-  2 mm - 0.08"
-  45 g - 1.58 oz

-  **Legno di Zebrawood**
Zebrawood
-  **Acciaio inox AISI 420 satinato**
Satin AISI 420 Stainless Steel
-  **Acciaio inox AISI 420J2B lucido**
Polished AISI 420J2B Stainless Steel
-  **Legno di Zebrawood**
Zebrawood
-  **Acciaio inox AISI 416 lucido**
Polished AISI 416 Stainless Steel

LINER LOCK

BF-79



-  AISI 440A
- HRC** 55-57
-  Satinata
Satin
-  2 mm - 0.08"
-  60 g - 2.11 oz

-  **Acciaio inox AISI 440A satinato**
Satin AISI 440A stainless steel
-  **Acciaio inox AISI 420 lucido**
Polished AISI 420 Stainless Steel
-  **Acciaio inox AISI 420 lucido**
Polished AISI 420 Stainless Steel
-  **Acciaio inox AISI 416 lucido**
Polished AISI 416 Stainless Steel
-  **Cuoio**
Leather

LINER LOCK

BF-74



- AISI 440A
- HRC** 55-57
- PVD (Physical Vapor Deposition)
- 3 mm - 0.12"
- 60 g - 2.11 oz
- Alluminio aeronautico sabbiato e PVD
Bead blasted and PVD aircraft aluminum

- Acciaio inox AISI 420 PVD
PVD AISI 420 Stainless Steel
- Acciaio inox AISI 420J2B PVD
PVD AISI 420J2B Stainless Steel
- Acciaio inox AISI 420 PVD
PVD AISI 420 Stainless Steel
- Acciaio inox AISI 420 PVD
PVD AISI 420 Stainless Steel
- Acciaio inox AISI 416 PVD
PVD AISI 416 Stainless Steel

FRAME LOCK

BF-73



- AISI 440A
- HRC** 55-57
- PVD (Physical Vapor Deposition)
- 3 mm - 0.12"
- 105 g - 3.70 oz
- Acciaio inox AISI 420 sabbiato + legno di sandalo - Bead blasted AISI 420 Stainless steel + sandal wood

- Acciaio inox AISI 420 sabbiato
Bead blasted AISI 420 Stainless Steel
- Acciaio inox AISI 420J2B black idrogliker
Black idrogliker AISI 420J2B Stainless Steel
- Acciaio inox AISI 420 black idrogliker
Black idrogliker AISI 420 Stainless Steel
- Acciaio inox AISI 420 black idrogliker
Black idrogliker AISI 420 Stainless Steel
- Acciaio inox AISI 416 black idrogliker
Black idrogliker AISI 416 Stainless Steel

LINER LOCK

BF-69



- AISI 440A
- HRC** 55-57
- PVD (Physical Vapor Deposition)
- 2,5 mm - 0.10"
- 120 g - 4.23 oz
- Alluminio anodizzato nero + legno di sandalo
Black anodized Aluminum + sandal wood

- Acciaio inox AISI 420 black idrogliker
Black idrogliker AISI 420 Stainless Steel
- Acciaio inox AISI 420J2B black idrogliker
Black idrogliker AISI 420J2B Stainless Steel
- Acciaio inox AISI 420 black idrogliker
Black idrogliker AISI 420 Stainless Steel
- Acciaio inox AISI 420 black idrogliker
Black idrogliker AISI 420 Stainless Steel
- Acciaio inox AISI 416 black idrogliker
Black idrogliker AISI 416 Stainless Steel

LINER LOCK

BF-90



- AISI 440A
- HRC** 55-57
- Satinata
Satin
- 3 mm - 0.12"
- 155 g - 5.46 oz
- Legno di sandalo; mostrine in acciaio inox AISI 420 satinato
Sandal wood; Satin AISI 420 Stainless Steel bolsters

- Acciaio inox AISI 420 lucido
Polished AISI 420 Stainless Steel
- Acciaio inox AISI 420 lucido
Polished AISI 420 Stainless Steel
- Acciaio inox AISI 420 lucido
Polished AISI 420 Stainless Steel
- Acciaio inox AISI 416 lucido
Polished AISI 416 Stainless Steel
- Cuoio
Leather

SLIP JOINT (Spuntone con leva di blocco - Spike with locking lever)

BF-237

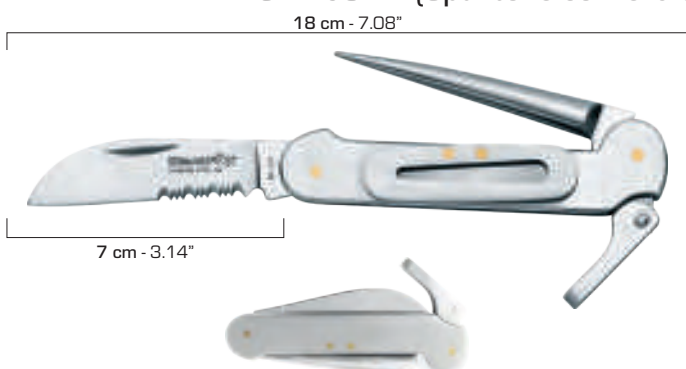



- AISI 420
- HRC** 54-55
- Satinata
Satin
- 2,5 mm - 0.10"
- 155 g - 5.46 oz

- Acciaio inox AISI 420 satinato
Satin AISI 420 stainless steel
- Acciaio inox AISI 420 satinato
Satin AISI 420 stainless steel
- Ottone lucido
Polished brass
- Acciaio inox AISI 420 lucido
Polished AISI 420 Stainless Steel

by Moris Baroni - LINER LOCK

BF-80





-  AISI 440A
- HRC** 55-57
-  PVD (Physical Vapor Deposition)
-  2 mm - 0.08"

-  **30 g - 1.05 oz**
-  **Zytel nero**
Black Zytel
-  **Acciaio inox AISI 420 PVD**
PVD AISI 420 Stainless Steel
-  **Acciaio inox AISI 416 black idrogliider**
Black idrogliider AISI 416 Stainless Steel

by Moris Baroni - LINER LOCK

BF-81



-  AISI 440A
- HRC** 55-57
-  PVD (Physical Vapor Deposition)
-  2 mm - 0.08"

-  **30 g - 1.05 oz**
-  **Zytel nero**
Black Zytel
-  **Acciaio inox AISI 420 PVD**
PVD AISI 420 Stainless Steel
-  **Acciaio inox AISI 416 black idrogliider**
Black idrogliider AISI 416 Stainless Steel

LINER LOCK

BF-920



-  AISI 440A
- HRC** 55-57
-  **Satinata**
Satin
-  2 mm - 0.08"

-  **30 g - 1.05 oz**
-  **Zytel arancione**
Orange Zytel
-  **Acciaio inox AISI 420 lucido**
Polished AISI 420 Stainless Steel
-  **Acciaio inox AISI 416 lucido**
Polished AISI 416 Stainless Steel

BACK LOCK

BF-105







-  AISI 440A
- HRC** 55-57
-  **Satinata**
Satin
-  3 mm - 0.12"
-  **100 g - 3.52 oz**

-  **G10 nero a trama fine**
Fine texture black G10
-  **Acciaio inox AISI 420 lucido**
Polished AISI 420 Stainless Steel
-  **Acciaio inox AISI 420J2B lucido**
Polished AISI 420J2B Stainless Steel
-  **Acciaio inox AISI 420 lucido**
Polished AISI 420 Stainless Steel
-  **Acciaio inox AISI 416 lucido**
Polished AISI 416 Stainless Steel

BACK LOCK

BF-105T



-  AISI 440A
- HRC** 55-57
-  PVD (Physical Vapor Deposition)
-  3 mm - 0.12"
-  **100 g - 3.52 oz**

-  **G10 nero a trama fine**
Fine texture black G10
-  **Acciaio inox AISI 420 PVD**
PVD AISI 420 Stainless Steel
-  **Acciaio inox AISI 420J2B PVD**
PVD AISI 420J2B Stainless Steel
-  **Acciaio inox AISI 420 PVD**
PVD AISI 420 Stainless Steel
-  **Acciaio inox AISI 416 PVD**
PVD AISI 416 Stainless Steel

LINER LOCK

BF-110TS



- AISI 440A
- HRC** 55-57
- PVD (Physical Vapor Deposition)
- 3 mm - 0.12"
- 135 g - 4.76 oz
- G10 nero a trama fine**
Fine texture black G10

- Acciaio inox AISI 420 black idroglider**
Black idroglider AISI 420 Stainless Steel
- Acciaio inox AISI 420J2B black idroglider**
Black idroglider AISI 420J2B Stainless Steel
- Acciaio inox AISI 420 PVD**
PVD AISI 420 Stainless Steel
- Acciaio inox AISI 420 black idroglider**
Black idroglider AISI 420 Stainless Steel
- Acciaio inox AISI 416 black idroglider**
Black idroglider AISI 416 Stainless Steel
- Nylon® 1000D**

LINER LOCK

BF-114



- AISI 440A
- HRC** 55-57
- Satinata**
Satin
- 3 mm - 0.12"
- 135 g - 4.76 oz
- G10 nero a trama fine**
Fine texture black G10

- Acciaio inox AISI 420 lucido**
Polished AISI 420 Stainless Steel
- Acciaio inox AISI 420J2B black idroglider**
Black idroglider AISI 420J2B Stainless Steel
- Acciaio inox AISI 420 lucido**
Polished AISI 420 Stainless Steel
- Acciaio inox AISI 420 lucido**
Polished AISI 420 Stainless Steel
- Acciaio inox AISI 416 lucido**
Polished AISI 416 Stainless Steel
- Nylon® 1000D**

LINER LOCK

BF-111T



- AISI 440A
- HRC** 55-57
- PVD (Physical Vapor Deposition)
- 3 mm - 0.12"
- 135 g - 4.76 oz
- G10 nero a trama fine**
Fine texture black G10

- Acciaio inox AISI 420 black idroglider**
Black idroglider AISI 420 Stainless Steel
- Acciaio inox AISI 420J2B black idroglider**
Black idroglider AISI 420J2B Stainless Steel
- Acciaio inox AISI 420 PVD**
PVD AISI 420 Stainless Steel
- Acciaio inox AISI 420 PVD**
PVD AISI 420 Stainless Steel
- Acciaio inox AISI 416 black idroglider**
Black idroglider AISI 416 Stainless Steel
- Nylon® 1000D**

LINER LOCK

BF-115



- AISI 440A
- HRC** 55-57
- PVD (Physical Vapor Deposition)
- 3 mm - 0.12"
- 145 g - 5.11 oz
- G10 nero a trama grezza**
Coarse texture black G10

- Acciaio inox AISI 420 black idroglider**
Black idroglider AISI 420 Stainless Steel
- Acciaio inox AISI 420 temprato black idroglider**
Tempered black idroglider AISI 420 stainless steel
- Acciaio inox AISI 420 black idroglider**
Black idroglider AISI 420 Stainless Steel
- Acciaio inox AISI 420 black idroglider**
Black idroglider AISI 420 Stainless Steel
- Acciaio inox AISI 416 black idroglider**
Black idroglider AISI 416 Stainless Steel
- Nylon® 1000D**

LINER LOCK

BF-117



- 440A
- HRC** 55-57
- Satinata**
Satin
- 3 mm - 0.12"
- 155 g - 5.46 oz
- Alluminio anodizzato rosso**
Red anodized Aluminum

- Acciaio inox AISI 420 lucido**
Polished AISI 420 Stainless Steel
- Acciaio inox AISI 420 temprato**
Tempered AISI 420 stainless steel
- Acciaio inox AISI 420 lucido**
Polished AISI 420 Stainless Steel
- Acciaio inox AISI 420 lucido**
Polished AISI 420 Stainless Steel
- Acciaio inox AISI 416 lucido**
Polished AISI 416 Stainless Steel
- Nylon® 1000D**





BlackFox
STAINLESS STEEL 440C

BF-719



COLTELLI LAMA FISSA BLACKFOX **BLACKFOX FIXED BLADE KNIVES**

Lame perfezionate per la caccia, le attività all'aria aperta e l'uso tattico militare. Ideali sia per chi intraprende per la prima volta queste attività, sia per chi intende ampliare la propria collezione con un coltello speciale.

Improved blades for hunting, outdoor activities and tactical military use. Ideal both for those who undertake these activities for the first time, and for those who intend to expand their collection with a special knife.

NEW!

EXPLORATOR by Alfredo Doricchi - LAMA FISSA/FIXED BLADE

BF-749



- AISI 440C
- HRC** 57-59
- Stone washed
- 4 mm - 0.16"
- 180 g - 6.34 oz

- Micarta marrone sagomata**
Contoured brown canvas Micarta
- Acciaio inox AISI 420 Lucido**
Polished AISI 420 Stainless Steel
- Kydex® con acciarino**
Kydex® with fire starter

COMPANION - LAMA FISSA/FIXED BLADE

BF-741



- AISI 440C
- HRC** 57-59
- Satinata**
Satin
- 4 mm - 0.16"
- 165 g - 5.82 oz

- Pakkawood lavorato in 3D**
3D machined Pakkawood
- Acciaio inox AISI 303 Lucido**
Polished AISI 303 Stainless Steel
- Cuoio**
Leather

LAMA FISSA/FIXED BLADE

BF-010WD



- AISI 440C
- HRC** 57-59
- Satinata**
Satin
- 3 mm - 0.12"
- 132 g - 4.65 oz

- Legno di Sandalo sagomato; mostrine in acciaio inox AISI 430 satinato**
Contoured Sandal wood; Satin AISI 430 Stainless Steel bolsters
- Cuoio**
Leather
- Acciaio inox AISI 303 Lucido**
Polished AISI 303 Stainless Steel

LAMA FISSA/FIXED BLADE

BF-007WD



- AISI 440C
- HRC** 57-59
- Satinata**
Satin
- 4 mm - 0.16"
- 180 g - 6.34 oz

- Legno di Sandalo nero sagomato; Mostrine in acciaio inox AISI 430 lucido**
Contoured black Sandal wood; Polished AISI 430 Stainless Steel bolsters
- Ottone**
Brass
- Cuoio**
Leather

LAMA FISSA/FIXED BLADE

BF-132



- AISI 440A
- HRC** 55-57
- Satinata**
Satin
- 4 mm - 0.16"
- 220 g - 7.76 oz



- G10 arancio sagomato**
Contoured orange G10
- Acciaio inox AISI 416 lucido**
Polished AISI 416 Stainless Steel
- Nylon® 1000D**

LAMA FISSA/FIXED BLADE

BF-006WD



-  AISI 440A
- HRC** 55-57
-  Satinata
Satin
-  4 mm - 0.16"
-  **250 g - 8.81 oz**



-  **Pakkawood lavorato in 3D; Mostrine in acciaio inox AISI 430 lucido**
3D machined Pakkawood; Polished AISI 430 Stainless Steel bolsters
-  **Ottone lucido**
Polished Brass
-  **Cuoio**
Leather

LAMA FISSA/FIXED BLADE

BF-004WD



-  AISI 440A
- HRC** 55-57
-  Satinata
Satin
-  4 mm - 0.16"
-  **255 g - 8.99 oz**



-  **Pakkawood lavorato in 3D; Mostrine in acciaio inox AISI 430 lucido**
3D machined Pakkawood; Polished AISI 430 Stainless Steel bolsters
-  **Ottone lucido**
Polished Brass
-  **Cuoio**
Leather

LAMA FISSA/FIXED BLADE

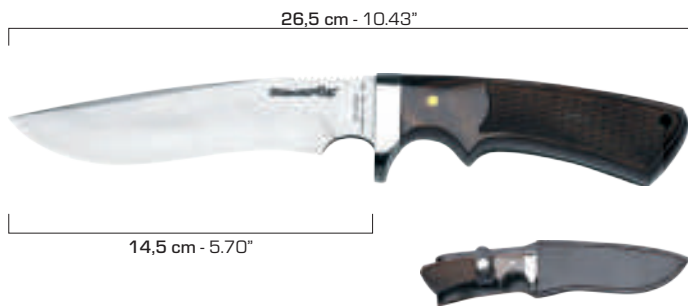
BF-001SD



-  AISI 440A
- HRC** 55-57
-  Satinata
Satin
-  4 mm - 0.16"
-  **255 g - 8.99 oz**



-  **Pakkawood lavorato in 3D; Mostrine in acciaio inox AISI 430 lucido**
3D machined Pakkawood; Polished AISI 430 Stainless Steel bolsters
-  **Ottone lucido**
Polished Brass
-  **Cuoio**
Leather

VESUVIUS by Alfredo Doricchi - LAMA FISSA/FIXED BLADE

BF-710



-  AISI 440C
- HRC** 57-59
-  Stone washed
-  4,5 mm - 0.18"

-  **230 g - 8.12 oz**
-  **G10 nero sagomato**
Contoured black G10
-  **Kydex® con TEK-LOK e accarino**
Kydex® with TEK-LOK and fire starter

DIPPRASAD by Alfredo Doricchi - LAMA FISSA/FIXED BLADE

BF-711







-  AISI 440C
- HRC** 57-59
-  Stone washed
-  5,5 mm - 0.22"

-  **340 g - 12.00 oz**
-  **G10 nero sagomato**
Contoured black G10
-  **Kydex® con TEK-LOK clip**
Kydex® with TEK-LOK clip

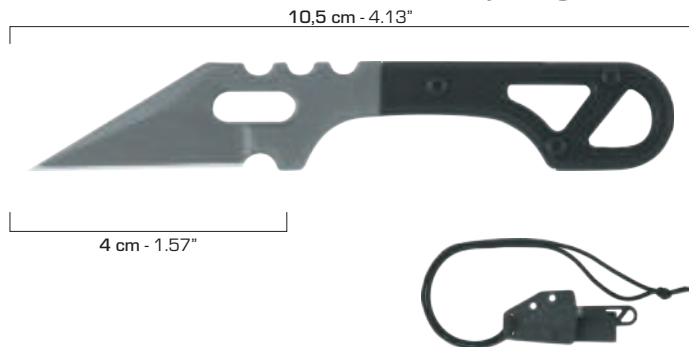
SPIKE by Serge Panchenko - LAMA FISSA/FIXED BLADE

BF-728





-  **AISI 440C**
- HRC 57-59**
-  **PVD (Physical Vapor Deposition)**
-  **4,5 mm - 0.18"**





-  **50 g - 1.76 oz**
-  **G10 nero a trama fine**
Fine texture Black G10
-  **Acciaio inox AISI 416 black idroglider**
Black idroglider AISI 416 Stainless Steel
-  **Kydex®**

SPECWARCOM by Jean Marc Meredieu - LAMA FISSA/FIXED BLADE

BF-730



-  **AISI 440C**
- HRC 57-59**
-  **Black idroglider stone washed**
-  **4 mm - 0.16"**



-  **85 g - 3.00 oz**
-  **G10 nero bombato**
Contoured Black G10
-  **Acciaio inox AISI 416 black idroglider**
Black idroglider AISI 416 Stainless Steel
-  **Kydex®**

SKELERGO by Peter Fegan - LAMA FISSA/FIXED BLADE

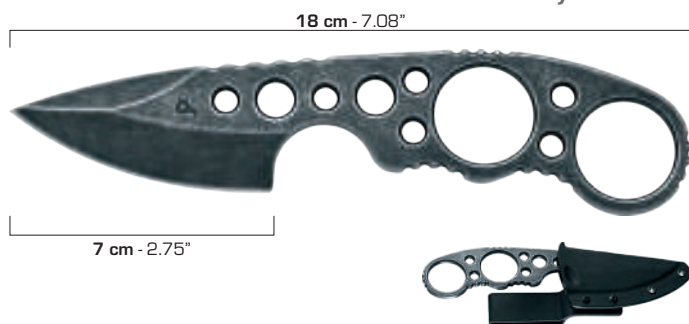
BF-734



-  **AISI 440C**
- HRC 57-59**
-  **PVD stone washed**
-  **4 mm - 0.16"**

-  **40 g - 1.41 oz**
-  **Acciaio inox AISI 440C PVD stone washed**
PVD stone washed AISI 440C Stainless Steel
-  **Kydex®**

MICRO by Alfredo Doricchi - LAMA FISSA/FIXED BLADE

BF-712



-  **AISI 440C**
- HRC 57-59**
-  **Satinata**
Satin
-  **3,5 mm - 0.14"**



-  **50 g - 1.76 oz**
-  **Corda di Nylon®**
Nylon® cord
-  **Kydex®**

TARLO by Alfredo Doricchi - LAMA FISSA/FIXED BLADE

BF-713







-  **AISI 440C**
- HRC 57-59**
-  **Satinata**
Satin
-  **3,5 mm - 0.14"**

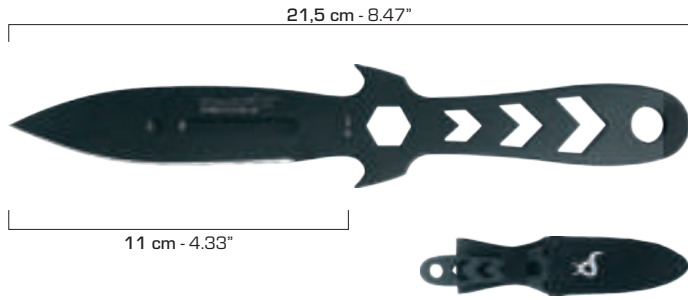

-  **80 g - 2.82 oz**
-  **Corda di Nylon®**
Nylon® cord
-  **Kydex® con MOLLE-Lock clip**
Kydex® with MOLLE-Lock clip

LAMA FISSA/FIXED BLADE

BF-722







-  AISI 440A
- HRC** 55-57
-  PVD (Physical Vapor Deposition)
-  3,5 mm - 0.15"

-  95 g - 3.35 oz
-  Acciaio inox AISI 440A PVD
PVD Stainless steel AISI 440A
-  Nylon®

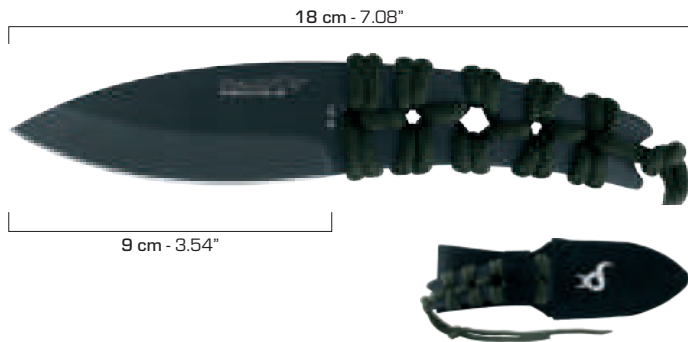
LAMA FISSA/FIXED BLADE

BF-724





-  AISI 440A
- HRC** 55-57
-  PVD (Physical Vapor Deposition)
-  4 mm - 0.16"

-  110 g - 3.88 oz
-  Corda di Nylon®
Nylon® cord
-  Nylon®

LAMA FISSA/FIXED BLADE

BF-726





-  AISI 440A
- HRC** 55-57
-  PVD (Physical Vapor Deposition)
-  4 mm - 0.16"



-  110 g - 3.88 oz
-  Corda di Nylon®
Nylon® cord
-  Nylon®

LAMA FISSA/FIXED BLADE

BF-720







-  AISI 440A
- HRC** 55-57
-  PVD (Physical Vapor Deposition)
-  4 mm - 0.16"

-  70 g - 2.47 oz
-  Acciaio inox AISI 440A PVD
PVD Stainless steel AISI 440A
-  Nylon®

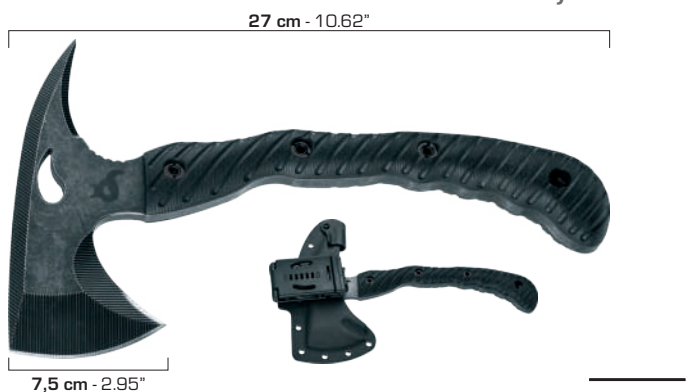
EVOLUTION TOMAHAWK by Peter Fegan - LAMA FISSA/FIXED BLADE

BF-735



-  AISI 440C
- HRC** 57-59
-  Black idrogliider stone washed
-  7 mm - 0.28"





-  515 g - 18.16 oz
-  G10 nero lavorato in 3D
3D machined black G10
-  Acciaio inox AISI 416 black idrogliider
Black idrogliider AISI 416 Stainless Steel
-  Kydex® con TEK-LOK clip
Kydex® with TEK-LOK clip

7,5 cm - 2.95"

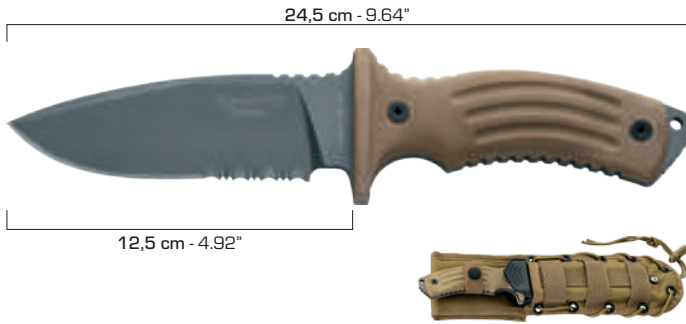
TORA by Antonio Di Gennaro - LAMA FISSA/FIXED BLADE

BF-700T



-  **AISI 440C**
- HRC 57-59**
-  **PVD (Physical Vapor Deposition)**
-  **5 mm - 0.20"**
-  **275 g - 9.70 oz**



-  **G10 coyote tan lavorato in 3D**
3D machined coyote tan G10
-  **Acciaio inox AISI 420**
AISI 420 stainless steel
-  **Nylon® 1000D con sistema MOLLE**
e sede in FRN® (Nylon rinforzato con
fibra di vetro)
1000D Nylon® with MOLLE system and
FRN® (Fiberglass Reinforced Nylon) sleeve

LAMA FISSA/FIXED BLADE

BF-CL16P



-  **AISI 420C**
- HRC 55-57**
-  **Satinata**
Satin
-  **1 mm - 0.04"**



-  **140 g - 4.93 oz**
-  **PP + TPR**
-  **Polipropilene**
Polypropylene

LAMA FISSA/FIXED BLADE

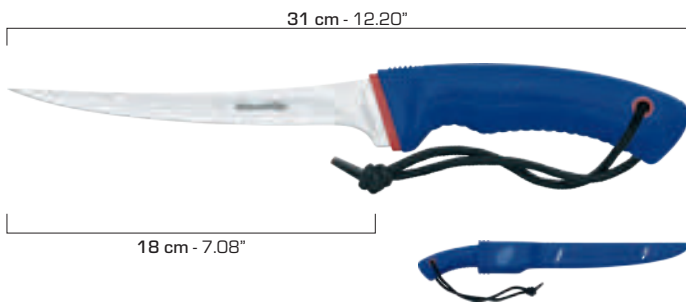
BF-CL18P



-  **AISI 420C**
- HRC 55-57**
-  **Satinata**
Satin
-  **1 mm - 0.04"**



-  **140 g - 4.93 oz**
-  **PP + TPR**
-  **Polipropilene**
Polypropylene

LAMA FISSA/FIXED BLADE

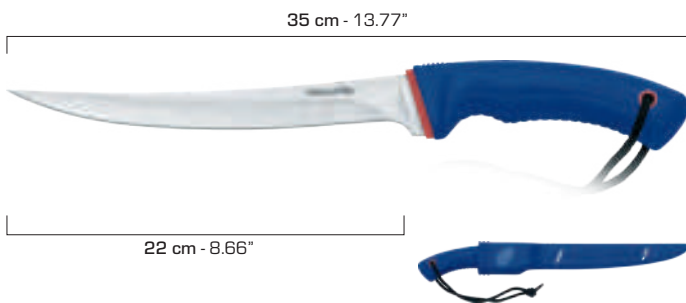
BF-CL22P



-  **AISI 420C**
- HRC 55-57**
-  **Satinata**
Satin
-  **1 mm - 0.04"**

-  **140 g - 4.93 oz**
-  **PP + TPR**
-  **Polipropilene**
Polypropylene



BlackFox[®]
STAINLESS STEEL 440 C

BF-711

**ATTREZZI MULTIUSO E BUSSOLE
BLACKFOX**
BLACKFOX MULTITOOLS AND
COMPASSES

Tenere con sè un attrezzo multiuso rende sempre pronti ad affrontare grandi e piccoli lavori di ogni giorno. Nelle escursioni, come nelle avventure giornaliere c'è sempre bisogno di un mezzo affidabile.

Keeping a multipurpose tool with you makes you always ready to face large and small everyday jobs. On excursions, as in daily adventures, a reliable tool is always needed.



NEW!

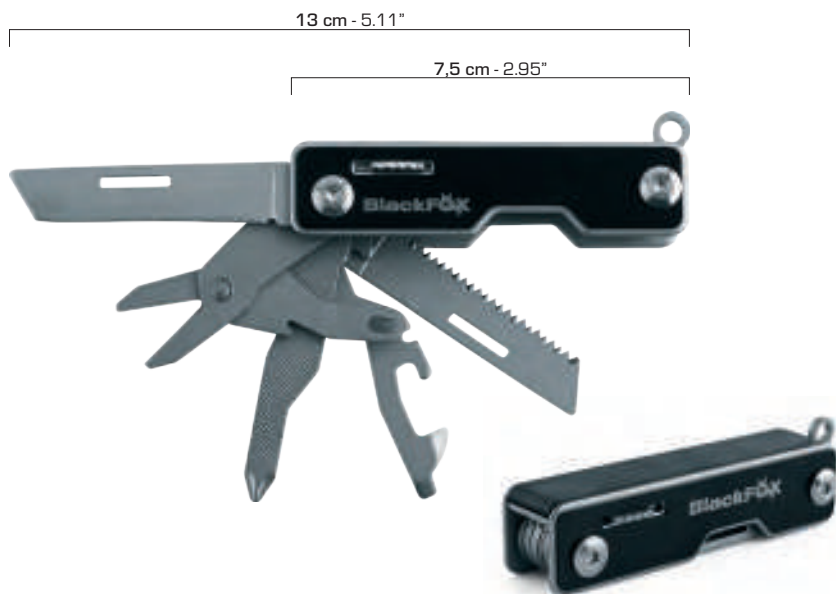

POCKET BOSS

BF-205

COMPONENTI - COMPONENTS

- lama coltello - blade 5cm - 1.96"
- forbici - scissors
- sega - saw
- apri scatole - can opener
- apri bottiglie - bottle opener
- lima per unghie - nail file
- cacciavite a stella - philips screwdriver
- cacciavite a testa piatta - with flat screwdriver
- attacco per catenella - keychain attachment

 **AISI 420**

 **Sabbiata**
Bead Blasted

 **Alluminio nero e ABS nero**
Black Aluminium and black ABS

 **83 g - 2.92 oz**

NEW!



POCKET BOSS

BF-205 OR

COMPONENTI - COMPONENTS

- lama coltello - blade 5cm - 1.96"
- forbici - scissors
- sega - saw
- apri scatole - can opener
- apri bottiglie - bottle opener
- lima per unghie - nail file
- cacciavite a stella - philips screwdriver
- cacciavite a testa piatta - with flat screwdriver
- attacco per catenella - keychain attachment

 **AISI 420**

 **Sabbiata**
Bead Blasted

 **Alluminio nero e ABS arancio**
Black Aluminium and orange ABS

 **83 g - 2.92 oz**

NEW!



POCKET BOSS

BF-205 R

COMPONENTI - COMPONENTS

- lama coltello - blade 5cm - 1.96"
- forbici - scissors
- sega - saw
- apri scatole - can opener
- apri bottiglie - bottle opener
- lima per unghie - nail file
- cacciavite a stella - philips screwdriver
- cacciavite a testa piatta - with flat screwdriver
- attacco per catenella - keychain attachment

 **AISI 420**

 **Sabbiata**
Bead Blasted

 **Alluminio nero e ABS rosso**
Black Aluminium and red ABS

 **83 g - 2.92 oz**

NEW!

ENDURANCE

BF-203



COMPONENTI - COMPONENTS

- pinza a becco - needlenose pliers
- pinza - pliers
- tagliafilì - wire cutter
- lama coltello - blade 8 cm - 3.14"
- forbici - scissors
- taglierino - multipurpose cutter
- apribottiglie con cacciavite a testa piatta - bottle opener with flat screwdriver
- apriscatole con cacciavite a testa piatta - can opener with flat screwdriver
- cacciavite a stella con chiusura di sicurezza - philips screwdriver with locking system
- punteruolo - awl
- lima per unghie - nail file
- sega - saw



17,5 cm - 6.88"



11 cm - 4.33"



AISI 420

Sabbiata
Bead Blasted



265 g - 9.34 oz

Nylon®



NEW!

RESILIENCE

BF-204



COMPONENTI - COMPONENTS

- pinza a becco - needlenose pliers
- pinza - pliers
- tagliafilì - wire cutter
- lama coltello - blade 8 cm - 3.14"
- forbici - scissors
- taglierino - multipurpose cutter
- apribottiglie con cacciavite a testa piatta - bottle opener with flat screwdriver
- apriscatole con cacciavite a testa piatta - can opener with flat screwdriver
- cacciavite a stella - philips screwdriver
- punteruolo - awl
- clip - pocket clip



17,5 cm - 6.88"



10,6 cm - 4.17"



AISI 420

PVD



269 g - 9.48 oz

Nylon®





17,5 cm - 6.88"

COMPONENTI - COMPONENTS

- pinza a becco - head plier
- tagliafilì - wire cutter
- placca di protezione utensili - tooling handle cover
- lama dentata - serrated blade
- apriscatole - can opener
- spuntone - spike
- seghetto - double toothed wood saw
- cacciavite a stella - phillips screw driver
- lima - file
- apribottiglie - cap opener
- cacciavite - screwdriver
- lama coltello - blade 8 cm - 3.14"
- apri bulloni - bolt opener



AISI 420



PVD



265 g - 9.34 oz



Nylon®

11,5 cm - 4.52"



10,5 cm - 4.10"

COMPONENTI - COMPONENTS

- pinza a becco - head plier
- tagliafilì - wire cutter
- forbice - scissors
- seghetto - double toothed wood saw
- cacciavite a stella - phillips screw driver
- lima - file
- cacciavite - screwdriver
- lama coltello - blade 7 cm - 2.75"
- punteruolo - awl



AISI 420



Stone washed

G10 nera trama grezza
Coarse texture Black G10

167 g - 5.90 oz



Nylon®

10,5 cm - 4.13"





**TS 819
MILITARY COMPASS**



**TS 815
COMPASS**



**TS 807
OUTDOOR COMPASS**



**TS 816
COMPASS**



**TS 825
POCKET COMPASS**



**TS 820
MILITARY COMPASS**



**TS 828
MAP COMPASS**

A person wearing brown leather gloves and a brown jacket is using a black multi-tool with a shovel attachment to dig in the ground. The multi-tool is a long-handled shovel with a black plastic handle and a black metal shovel head. The person is kneeling on the ground, and the shovel is partially buried in the soil. The background is a blurred outdoor setting with grass and dirt.

ATTREZZI MULTIUSO ED ACCESSORI MULTITOOLS AND ACCESSORIES

Laddove il lavoro include operazioni al di fuori delle potenzialità del coltello, offriamo un'ampia gamma di strumenti sia multiuso che specifici. Inoltre qui presentiamo tutti gli accessori che possano accompagnare i nostri coltelli.

When the job includes operations beyond the potential of the knife, we offer a wide range of both multipurpose and specific tools. Also here we present all the accessories that may accompany our knives.

SOG STUDIES AND OBSERVATIONS GROUP



17,2 cm - 6,80"

COMPONENTI - COMPONENTS

- | pinza a becco - pliers
- | pinze - grippers
- | porta punte esagonale magnetico
magnetic hex bit holder
- | taglia fili grosso - hard wire cutter
- | taglia fili sottile - soft wire cutter
- | lama coltello da 7 cm - 2.75" straight blade
- | forbici a lama seghettata da 7 cm
2.75" serrated blade scissors
- | seghetto da 7 cm - 2.75" saw
- | lima a tre lati - three-sided file
- | cacciavite a stella - phillips #1 screwdriver
- | punteruolo - awl
- | cacciavite di precisione - jewelry driver
- | apri scatole - can opener
- | cacciavite a testa piatta di piccole dimensioni
small flat-head screwdriver
- | apri bottiglie - bottle opener
- | cacciavite a testa piatta di medie dimensioni
medium sized flat head driver
- | cacciavite da 2,5 cm - 1/4" driver
- | scalpello - chisel
- | righello - inch and centimeter scales
- | goniometro - protractor



Stone washed



345 g - 12.16 oz

SOG STUDIES AND OBSERVATIONS GROUP



10,5 cm - 4,10"

COMPONENTI - COMPONENTS

- | pinza a becco - pliers
- | pinze - grippers
- | crimpatore - crimper
- | apri scatole - can opener
- | apri bottiglie - bottle opener
- | punteruolo - awl
- | lima a tre lati - three-sided file
- | righelli - rulers
- | goniometro - protractor
- | taglia fili sottile - soft wire cutter
- | taglia fili grosso - hard wire cutter
- | cacciavite a testa piatta di piccole dimensioni
small flat-head screwdriver
- | cacciavite a stella - phillips #1 screwdriver
- | cacciavite a testa piatta di piccole dimensioni
small flat-head screwdriver
- | lama coltello - straight blade
- | cacciavite di precisione - jewelry driver
- | cacciavite a testa piatta di grandi dimensioni
large flat-head screwdriver
- | porta punte esagonale magnetico
magnetic hex bit holder



Stone washed



167 g - 5.90 oz

SOG STUDIES AND OBSERVATIONS GROUP



COMPONENTI - COMPONENTS

- pinza a becco - plier
- pinza - gripper
- porta punta esagonale magnetico
magnetic hex bit holder
- taglia fili grosso - hard wire cutter
- taglia fili sottile - soft wire cutter
- lama coltello da 7 cm - 2.75" straight blade
- forbici - scissors
- taglierino - line cutter
- cacciavite a stella - phillips #1 screwdriver
- punteruolo - awl
- cacciavite di precisione - jewelry driver
- apri scatole - can opener
- cacciavite a testa piatta di piccole dimensioni
small flat-head screwdriver
- apri bottiglie - bottle opener
- cavatappi - corkscrew
- righello - inch and centimeter scales
- goniometro - protractor



Stone washed



130 g - 4.60 oz

SOG STUDIES AND OBSERVATIONS GROUP



COMPONENTI - COMPONENTS

- pinza a becco - pliers
- pinze - grippers
- porta punta esagonale magnetico
magnetic hex bit holder
- taglia fili grosso - hard wire cutter
- taglia fili sottile - soft wire cutter
- lama coltello da 7 cm - 2.75" straight blade
- forbici a lama seghettata da 7 cm
2.75" serrated blade scissors
- seghetto da 7 cm - 2.75" saw
- lima a tre lati - three-sided file
- cacciavite a stella - phillips #1 screwdriver
- punteruolo - awl
- cacciavite di precisione - jewelry driver
- apri scatole - can opener
- cacciavite a testa piatta di piccole dimensioni
small flat-head screwdriver
- apri bottiglie - bottle opener
- cacciavite a testa piatta di medie dimensioni
medium sized flat head driver
- cacciavite da 2,5 cm - 1/4" driver
- scalpello - chisel
- righello - inch and centimeter scales
- goniometro - protractor



Stone washed



119 g - 4.20 oz



14 cm - 5.51"

COMPONENTI - COMPONENTS

forbici ad apertura assistita
scissors with assisted opening

penna a sfera sostituibile
replaceable pressurized ballpoint pen

apri bottiglie - bottle opener

cacciavite a testa piatta medio
medium flat-head screwdriver



Stone washed



60 g - 2.11oz



15,2 cm - 5.98"

COMPONENTI - COMPONENTS

lama dritta - straight blade

pila a LED (batterie AA)
LED flashlight (AA Battery)

apri bottiglie - bottle opener

cacciavite a testa piatta medio
medium flat-head screwdriver



Stone washed



80 g - 2.82 oz

SOG STUDIES AND OBSERVATIONS GROUP



19,5 cm - 7.67"

COMPONENTI - COMPONENTS

- pinza a becco - pliers
- pinza - gripper
- lima a tre lati - three-sided file
- punteruolo - awl
- scalpello - chisel
- apriscatole - can opener
- taglia fili sottile - soft wire cutter
- lama dritta - straight blade
- cacciavite a stella - phillips screwdriver
- cacciavite a testa piatta di piccole dimensioni - small flat-head screwdriver
- apri bottiglie - bottle opener
- cacciavite a testa piatta medio - medium flat-head screwdriver
- cacciavite di precisione - jewelry driver



Stone washed



175 g - 6.17oz

SOG STUDIES AND OBSERVATIONS GROUP



19,5 cm - 7.67"

COMPONENTI - COMPONENTS

- pinza a becco - pliers
- pinze - gripper
- lima a tre lati - three-sided file
- apri bottiglie - bottle opener
- apriscatole - can opener
- taglia fili sottile - soft wire cutter
- lama dritta - straight blade
- cacciavite a testa piatta di piccole dimensioni - small flat-head screwdriver
- cacciavite a testa piatta medio - medium flat-head screwdriver
- cacciavite esagonale (magnetico, 1/4", cricchetto) - hex bit driver (magnetic, 1/4", ratchet)
- set di punte esagonali da 12 pezzi - 12-Piece Hex Bit Kit



Stone washed



175 g - 6.17oz

SOG STUDIES AND
OBSERVATIONS
GROUP



17,8 cm - 7.00"

COMPONENTI - COMPONENTS

pinza a becco - plier

crimpatore - crimper

taglia fili - blasting cap crimper

placca di protezione utensili removibile
removable handle cover

cacciavite a stella - phillips #1 screwdriver

apri bottiglie - bottle opener

cacciavite a testa piatta di piccole dimensioni
small flat-head screwdriver

lama V cut - V cut blade

seghetto - double toothed wood saw

apri scatole - can opener

lama coltello - straight blade

lama coltello dentata - serrated blade

 NSN 5110-15-193-2809



Black idroglider



265 g - 9.34oz

POWER ASSIST EOD - MULTI-TOOLS SOG 182/B66 EOD

SOG STUDIES AND
OBSERVATIONS
GROUP



17,8 cm - 7.00"

COMPONENTI - COMPONENTS

pinza a becco - pliers

crimpatore - crimper

taglia fili - blasting cap crimper

placca di protezione utensili removibile
removable handle cover

cacciavite a stella - phillips #1 screwdriver

apri bottiglie - bottle opener

cacciavite a testa piatta di piccole dimensioni
small flat-head screwdriver

lama V cut - V cut blade

seghetto - double toothed wood saw

apri scatole - can opener

lama coltello - straight blade

lama coltello dentata - serrated blade



Black idroglider



265 g - 9.34oz





MTD by Allen Elishewitz - TACTICAL PEN

MTD B

13,7 cm - 5.40"



 35 g - 1.23 oz

 **Alluminio 6082 anodizzato nero**
Black anodized Aluminum 6082
Acciaio inox
Stainless steel

MTD by Allen Elishewitz - TACTICAL PEN

MTD BL

13,7 cm - 5.40"



 35 g - 1.23 oz

 **Alluminio 6082 anodizzato blu**
Blue anodized Aluminum 6082
Acciaio inox
Stainless steel

MTD by Allen Elishewitz - TACTICAL PEN

MTD G

13,7 cm - 5.40"



 35 g - 1.23 oz

 **Alluminio 6082 anodizzato grigio**
Gray anodized Aluminum 6082
Acciaio inox
Stainless steel

MTD by Allen Elishewitz - TACTICAL PEN

MTD OD

13,7 cm - 5.40"



 35 g - 1.23 oz

 **Alluminio 6082 anodizzato verde**
Green anodized Aluminum 6082
Acciaio inox
Stainless steel

MTD by Allen Elishewitz - TACTICAL PEN

MTD O

13,7 cm - 5.40"



 35 g - 1.23 oz

 **Alluminio 6082 anodizzato arancione**
Orange anodized Aluminum 6082
Acciaio inox
Stainless steel

MTD by Allen Elishewitz - TACTICAL PEN

MTD R

13,7 cm - 5.40"



 35 g - 1.23 oz

 **Alluminio 6082 anodizzato rosso**
Red anodized Aluminum 6082
Acciaio inox
Stainless steel



refills disponibili su richiesta
 spare refills available on demand

S 8126N > Black

S 8126B > Blue



MTD II - TACTICAL PEN

MTD/2 G

15 cm - 5.90"



Kg 35 g - 1.23 oz

-  **Alluminio 6082 anodizzato grigio**
Gray anodized Aluminum 6082
-  **Acciaio inox**
Stainless steel



MTD II- TACTICAL PEN

MTD/2 OD

15 cm - 5.90"



Kg 35 g - 1.23 oz

-  **Alluminio 6082 anodizzato verde**
Green anodized Aluminum 6082
-  **Acciaio inox**
Stainless steel



MTD II- TACTICAL PEN

MTD/2 BL

15 cm - 5.90"



Kg 35 g - 1.23 oz

-  **Alluminio 6082 anodizzato blu**
Blue anodized Aluminum 6082
-  **Acciaio inox**
Stainless steel

KIT SONDA MINE - MINE PROBE KIT

FX-MP01 TI KIT



Attrezzo multiuso NON incluso nel kit
 E.O.D. tool NOT included



Un kit completo include:

- 1 manico cm 16
- 4 bastoncini in titanio cm 14
- 3 punte in titanio cm 4
- 3 punte in POM
- manico POM
- fodero Nylon® 1000D con sistema MOLLE

One full kit includes:

- 1 handle 6.29"
- 4 titanium sticks 5.51"
- 3 interchangeable titanium tips 1.57"
- 3 interchangeable POM tips
- handle POM
- sheath Nylon® 1000D MOLLE compatible carrying sheath

 **NSN 5120-15-000-0215**

 76 cm - 29.92"

Kg 590 g - 20.81oz



AISI 420

HRC 54-66



Black idrogelider



1.245 g - 43.91 oz



Chiudibile brevettato in FRN® (Nylon rinforzato con fibra di vetro) e alluminio
Folding handle patent system FRN®
(Fiberglass Reinforced Nylon) and Aluminium



Nylon® 1000D con sistema MOLLE
Nylon® 1000D with MOLLE system

CLOSED 27,1 cm - 10.66 "

OPEN 60 cm - 23.62 "



Caratteristiche principali:

- manico pieghevole
- minimo ingombro
- tre diversi angoli di lavoro della pala:
90°, 135° e 180° rispetto al manico.
- robusta e leggera la pala pieghevole FKMD può essere facilmente trasportata in uno zaino, sotto il sedile dell'auto, in una barca o dovunque lo spazio è limitato.

Key features:

- folding handle
- three different working angles of the shovel: 90°, 135° and 180° to the handle
- FKMD folding spade is strong and light, it stores in tight spaces for easy transport in a backpack, in a boat or anywhere space is limited.



FX-0171111/1

fodero • sheath
Nylon® 1000D



FX-0171111

fodero • sheath
Nylon® 1000D
con sistema MOLLE • with MOLLE system



FOX RESCUE EMERGENCY TOOL - LAMA FISSA/FIXED BLADE

640



-  **420J2B**
- HRC** 54-56
-  **Satinata**
Satin
-  **1 mm - 0.03"**
-  **55 g - 1.94 oz**

-  **FRN® (Nylon® rinforzato con fibra di vetro) nero - Black FRN® (Fiberglass Reinforced Nylon®)**
-  **FRN® (Nylon® rinforzato con fibra di vetro) nero - Black FRN® (Fiberglass Reinforced Nylon®)**
-  **FRN® (Nylon® rinforzato con fibra di vetro) nero - Black FRN® (Fiberglass Reinforced Nylon®)**

 **NSN 5110-15-000-0215**

FOX RESCUE EMERGENCY TOOL - LAMA FISSA/FIXED BLADE

640/1

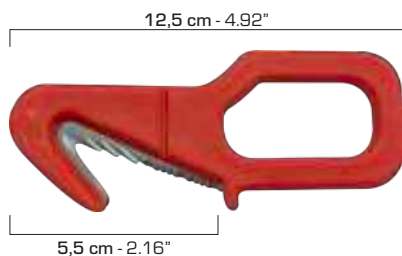

-  **420J2B**
- HRC** 54-56
-  **Satinata**
Satin
-  **1 mm - 0.03"**
-  **55 g - 1.94 oz**

-  **FRN® (Nylon® rinforzato con fibra di vetro) rosso - Red FRN® (Fiberglass Reinforced Nylon®)**
-  **FRN® (Nylon® rinforzato con fibra di vetro) rosso - Red FRN® (Fiberglass Reinforced Nylon®)**
-  **FRN® (Nylon® rinforzato con fibra di vetro) rosso - Red FRN® (Fiberglass Reinforced Nylon®)**

FOX RESCUE EMERGENCY TOOL - LAMA FISSA/FIXED BLADE

640 OD



-  **420J2B**
- HRC** 54-56
-  **Satinata**
Satin
-  **1 mm - 0.03"**
-  **55 g - 1.94 oz**

-  **FRN® (Nylon® rinforzato con fibra di vetro) verde DD - OD green FRN® (Fiberglass Reinforced Nylon®)**
-  **FRN® (Nylon® rinforzato con fibra di vetro) verde DD - OD green FRN® (Fiberglass Reinforced Nylon®)**
-  **FRN® (Nylon® rinforzato con fibra di vetro) verde DD - OD green FRN® (Fiberglass Reinforced Nylon®)**

FOX RESCUE EMERGENCY TOOL - LAMA FISSA/FIXED BLADE

FX-640/22RD



-  **420J2B**
- HRC** 54-56
-  **Satinata**
Satin
-  **1 mm - 0.03"**
-  **59 g - 2.08 oz**

-  **FRN® (Nylon® rinforzato con fibra di vetro) rosso - Red FRN® (Fiberglass Reinforced Nylon®)**
-  **FRN® (Nylon® rinforzato con fibra di vetro) rosso - Red FRN® (Fiberglass Reinforced Nylon®)**
-  **FRN® (Nylon® rinforzato con fibra di vetro) rosso - Red FRN® (Fiberglass Reinforced Nylon®)**

FOX RESCUE EMERGENCY TOOL - LAMA FISSA/FIXED BLADE

FX-640/22EY



-  **420J2B**
- HRC** 54-56
-  **Satinata**
Satin
-  **1 mm - 0.03"**
-  **59 g - 2.08 oz**

-  **FRN® (Nylon® rinforzato con fibra di vetro) giallo - Yellow FRN® (Fiberglass Reinforced Nylon®)**
-  **FRN® (Nylon® rinforzato con fibra di vetro) giallo - Yellow FRN® (Fiberglass Reinforced Nylon®)**
-  **FRN® (Nylon® rinforzato con fibra di vetro) giallo - Yellow FRN® (Fiberglass Reinforced Nylon®)**

FOX RESCUE EMERGENCY TOOL - LAMA FISSA/FIXED BLADE

FX-640/220D



15,5 cm - 6.10"

5,5 cm - 2.16"



420J2B

HRC 54-56

Satinata
Satin

1 mm - 0.03"

Kg 59 g - 2.08 oz

FRN® (Nylon® rinforzato con fibra di vetro) verde OD - OD green FRN® (Fiberglass Reinforced Nylon®)

FRN® (Nylon® rinforzato con fibra di vetro) verde OD - OD green FRN® (Fiberglass Reinforced Nylon®)

FRN® (Nylon® rinforzato con fibra di vetro) verde OD - OD green FRN® (Fiberglass Reinforced Nylon®)

ESPOSITORI - DISPLAYS



EXPO 5
H 8 x 19,5 x 19,3 cm
H 3.14 " x 7.67 " x 7.59 "
wood - legno



EXPO 6
H 9 x 13,3 x 17,5 cm
H 3.54 " x 5.23 " x 6.88 "
cuoio nero - black leather

ESPOSITORI - DISPLAYS



EXPO 11
H 5 x 9,5 x 14,5 cm
H 1.96 " x 3.74 " x 5.70 "
plastica - plastic



EXPO 12
H 4 x 4 cm
H 1.57 " x 1.57 "
plastica - plastic

ESPOSITORI - DISPLAYS



EXPO 13
H 13,5 x 11 x 8,5 cm
H 5.31 " x 4.33 " x 3.34 "
plastica - plastic



EXPO 14
H 9,5 x 19 x 24 cm
H 3.74 " x 7.48 " x 9.44 "
plastica - plastic

ESPOSITORI - DISPLAYS



EXPO 3
H 15 x 9 x 19 cm
H 5.9 " x 3.54 " x 6.69 "
plastica - plastic



FX-MATB
38 x 25 cm
14,96 " x 9,84 "
cuoio nero
black leather

FX-MATGR
38 x 25 cm
14,96 " x 9,84 "
cuoio verde OD
OD green leather

ESPOSITORI - DISPLAYS



EXPO 9

H 38 x 20 x 25 cm
H 14.96 " x 7.87 " x 9.84 "



EXPO 7

H 37 x 72 x 44 cm
H 14.56 " x 17.32 " x 28.34 "

ESPOSITORI - DISPLAYS



EXPO 10

H 38 x 20 x 25 cm
H 14.96 " x 7.87 " x 9.84 "



EXPO 8

H 37 x 72 x 44 cm
H 14.56 " x 17.32 " x 28.34 "

PIETRE GIAPPONESI PER AFFILARE - JAPANESE SHARPENER STONES



K-80001

grana - grain 240 / 1000
18 x 6,6 x 2,8 cm
7.08 " x 2.59 " x 1.10 "



K-80002

grana - grain 3000 / 8000
17,8 x 6 x 2,4 cm
7.00 " x 2.36 " x 0.94 "

PIETRE GIAPPONESI PER AFFILARE - JAPANESE SHARPENER STONES



HH-10
grana - grain 280
16,2 x 5 x 1,7 cm
6.37 " x 1.96 " x 0.66 "



HH-11
grana - grain 1000
16,4 x 5 x 1,7 cm
6.45 " x 1.96 " x 0.66 "

PIETRE GIAPPONESI PER AFFILARE - JAPANESE SHARPENER STONES



HH-12
grana - grain 3000
18,5 x 6,5 x 2 cm
7.28 " x 2.55 " x 0.78 "



HH-13
grana - grain 280 / 1000
18 x 5 x 2,4 cm
7.08 " x 1.96 " x 0.94 "

PIETRE NATURALI PER AFFILARE - NATURAL SHARPENER STONES



PLO01
grana fine naturale
14 x 8 x 2 cm
natural fine grain
5.51 " x 3.14 " x 0.78 "



PLO02
grana fine
10 x 5 x 1 cm
fine grain
3.93 " x 1.96 " x 0.39 "

PIETRE NATURALI PER AFFILARE - NATURAL SHARPENER STONES



PLO04
doppia grana fine/grossa
10 x 5 x 1,5 cm
double coarse grain
3.93 " x 1.96 " x 0.59 "



PLO05
doppia grana fine/grossa
7,5 x 3 x 1 cm
double coarse grain
2.95 " x 1.18 " x 0.39 "

PIETRE NATURALI PER AFFILARE - NATURAL SHARPENER STONES



PLO06
grana grossa
7,5 x 3,5 x 1 cm
coarse grain
2.95 " x 1.37 " x 0.39 "



PLO07
grana fine naturale
29 x 5,5 x 2 cm
natural fine grain
11.41 " x 2.16 " x 0.78 "

ACCIAINO CHIUDIBILE DIAMANTATO - FOLDING DIAMOND SHARPENER

BF-300



 60 g - 2.11oz

ovale - oval



ACCIAINO CHIUDIBILE DIAMANTATO - FOLDING DIAMOND SHARPENER

2C 730/7



 7 cm - 2.75"

 15 g - 0.52oz

ovale - oval

SURVIVAL KIT FX-0107153/1SK



FIRE STARTER

EX-001620-BLK



- Acciaio con superficie diamantata
- Acciaio in ceramica per diversi profili di lama
- Acciaio in carburo di silicio

CARATTERISTICHE PRODOTTO

- Acciaio multiuso versatile
- Materiali di prima qualità
- Struttura resistente con gomma antiscivolo
- Compatto, pratico e maneggevole
- Facile da usare e trasportare
- Ideale per le attività outdoor

Istruzioni per acciaio con superficie diamantata:

La superficie diamantata deve essere asciutta per essere utilizzata. Non vanno usati oli lubrificanti contenenti petrolio.

1. Estrarre la superficie diamantata, posizionare quindi la lama all'angolo di affilatura desiderato. Si consiglia un angolo tra i 10° e i 20°.
2. Esercitando una pressione moderata, far scorrere la lama sulla superficie diamantata. Ripetere l'operazione per 3 o 4 volte. Il segreto per ottenere un risultato perfetto è quello di mantenere sempre lo stesso angolo di affilatura.
3. Ripetere le stesse azioni anche sull'altro lato della lama.

Istruzioni per acciaio in ceramica:

1. Aprire il tappo in plastica ed estrarre gli acciaini in ceramica.
2. Selezionare la superficie di affilatura necessaria (triangolare, mezza luna o piatta). Inserire gli acciaini nei fori appositi.
3. Portare la lama avanti e indietro, eseguendo un movimento dall'alto verso il basso. Iniziare ad affilare la lama partendo dalla base del coltello verso la punta, mantenendo il coltello a un angolo di circa 90° dalla base. Ripetere l'azione per 8-10 volte.
4. Ripetere le stesse azioni anche sull'altro lato della lama.

Istruzioni per acciaio con carburo:

1. Posizionare la lama nello slot di affilatura con un angolo di 90°. Iniziare ad affilare la lama partendo dalla base del coltello verso la punta, facendo una pressione moderata.
2. Ripetere questi step per 3 o 4 volte, fino ad aver ottenuto il grado di affilatura desiderata.

INDICAZIONI PARTICOLARI

1. Utilizzare l'angolo triangolare dell'acciaio in ceramica per lame con profilo dentato. L'angolo triangolare affilerà in maniera perfetta anche le lame più piccole.
2. L'incisione a forma di V è per l'affilatura dell'amo da pesca.

ATTENZIONE

1. Evitare di utilizzare una forza eccessiva.
2. Pulire l'acciaio immediatamente dopo l'uso, con acqua corrente e asciugare completamente.
3. Mantenere l'acciaio e i relativi coltelli lontani dalla portata dei bambini.

- Diamond stone grinder
- Ceramic rods sharpener
- Carbide sharpening

PRODUCT FEATURES

- Multipurpose sharpener
- First quality materials
- Resistant structure with non-slip rubber
- Compact, practical and manageable
- Ease of use and to carry
- Perfect for the outdoor activities

Diamond Stone Grinder Instructions:

Stone can be used dry. Do not use petroleum based oil as a lubricant.

1. Pull out the diamond sharpening part, place your blade at the desired sharpening angle. We suggest an angle between 10-degree and 20-degree.
2. With moderate pressure pass the blade on the diamond stone. Repeat this action for 3 or 4 times. Try to maintain the same approximate angle with each stroke: this is the key to obtaining the sharp blade.
4. Sharpen the other side of the blade and repeat previous steps.

Ceramic Rods Instructions:

1. Open the plastic cap and take out the ceramic rods.
2. Select the sharpening surface you need - triangle, half round or flat. Insert the rods into the holes with the same sharpening surface.
3. Pull the blade down and across the ceramic rod starting from the back of the knife blade to the tip of the blade. Hold the knife at a 90-degree angle to the base. Repeat this action for about 8-10 strokes.
4. Repeat these steps on the right inside the rods to sharpen the other side of your knife.

Carbide Sharpening Instructions:

1. Place the knife blade in the sharpening slot with 90-degree angle. Start from the back of the knife blade to the tip of the blade.
2. Repeat these steps 3 or 4 times until your knife is sharp enough.

SPECIAL INSTRUCTION

1. Use the triangular shaped edge of the ceramic stone for serrated knife. The triangular edge will grind fluently, even extremely small serrated knives.
2. The V-shaped groove is for grinding the fishhook.

CAUTION

1. Avoid excessive force.
2. Clean the sharpener immediately after use with running water and dry completely.
3. Please put the sharpener and knife beyond the reach of children to avoid any accidents.



CARBIDE



DIAMOND



STORAGE



CERAMIC

COME AFFILARE IL VOSTRO COLTELLO FOX - HOW TO SHARPEN YOUR FOX KNIFE

Si consiglia di affilare la lama dei coltelli FOX solo con prodotti di ottima qualità. Le istruzioni da ricordare, se utilizzate una pietra o un acciaino per affilare il vostro coltello FOX, sono le seguenti:

- Prima di tutto applicate dell'olio a bassa viscosità per affilatura sulla pietra naturale grezza. Questo consentirà di rimuovere velocemente il vecchio filo.
- Tenere saldamente il coltello.
- Portare la lama avanti e indietro con un angolo di 10-20 gradi, come illustrato.
- Iniziare ad affilare la lama partendo dalla base del coltello verso la punta.
- Ripetere le stesse azioni anche sull'altro lato della lama.
- Ripetere i passaggi citati sopra, fino a che il nuovo filo del coltello non taglierà come in origine.
- Dopo l'affilatura, il coltello deve esser lavato in acqua e asciugato completamente.
- Se si desidera un filo estremamente tagliente, ripetere questa procedura utilizzando una pietra sempre più sottile, fino a che non sarete soddisfatti del filo realizzato al vostro coltello FOX.



ATTENZIONE:

- Non affilate il coltello tenendo la lama piatta sulla pietra o sull'acciaino.
- Se la lama viene tenuta con un angolo troppo inclinato rispetto alla pietra o all'acciaino, il risultato è la spuntatura e l'appiattimento del filo.
- Pulire la pietra o l'acciaino immediatamente dopo l'uso, con acqua corrente e asciugare completamente.

Se utilizzate altri strumenti per affilare la lama dei vostri coltelli, fate riferimento alle istruzioni del costruttore dell'apparecchio.

We suggest to sharpen the blade of your FOX knife using only top quality products. Please follow these steps when using a sharpening stone or a sharpener for your FOX knife:

- First apply abundant low-viscosity honing oil to a rough natural stone. This will allow the old cutting edge to be removed quickly.
- Hold the knife firmly.
- Draw the cutting edge to and from at an angle of 10-20 degrees as shown in the picture.
- Preferably start with the base and then work up to the point of the blade.
- Repeat the same action on the other side of the blade.
- Repeat the above steps until the new cutting edge of the knife performs just like the original blade.
- After sharpening, the knife should be washed in water and thoroughly dried.
- For an extremely sharp cutting edge, repeat the process using ever finer stones until you have achieved the desired degree of sharpness for your FOX knife.

WARNING:

- Do not sharpen the knife holding the blade flat against the stone.
- Holding the blade at too wide an angle from the stone will result in blunting and flattening of the edge.
- Clean the stone immediately after use with running water and dry completely.

If you use other tools to sharpen the blade, such as steel, please refer to the device manufacturer's instructions.





FODF3
 Nylon®



FODF3 NEUTRO Fodero con tessuto a strappo per patch
 Sheath with loop panel for patches.
 Nylon®



FODF3 CUOIO N
 Cuio
 Leather



FODF6 CUOIO
 Cuio
 Leather



TEK-LOK
 8,8 x 5 cm
 3.46" x 1.96"
 Nylon® rinforzato
 Reinforced Nylon®

MOLLE - LOCK clip
CLIP FX-211/213

12 x 2,4 cm
 4.72" x 0.94"
 Nylon® rinforzato
 Reinforced Nylon®



FODF1
 45 x 30 cm
 17.71" x 11.81"
 Nylon®



FX-ZF01
 H 40 x 39 cm
 15.74" x 15.35"



FODF4
 28 x 18 cm
 11.02" x 7.08"
 Nylon®

FODERI - SHEATHS



12 cm - 4.72"

35cm12

 Nylon®



13 cm - 5.11"

35cm13

 Nylon®



14 cm - 5.51"

35cm14

 Nylon®

FODERI - SHEATHS



10 cm - 3.93"

47cm10

 Ballistic Nylon®



13 cm - 5.11"

48cm13

 Ballistic Nylon®



14 cm - 5.51"

49cm14

 Ballistic Nylon®

FODERI - SHEATHS



9 cm - 3.54"

36cm09

 Cuoio
Leather



12 cm - 4.72"

37cm12

 Cuoio
Leather



10 cm - 3.93"

38cm10

 Cuoio
Leather

FODERI - SHEATHS



13 cm - 5.11"

42cm13

 Cuoio
Leather



14 cm - 5.51"

43cm14

 Cuoio
Leather



16 cm - 6.29"

FOD.749

 Cuoio
Leather

CAPPELLI - HATS



FX-CAP01B



FX-CAP01GR



FX-CAP01GY

TAGLIA UNICA
REGOLABILE
ONE SIZE ONLY
ADJUSTABLE

CATENELLE PORTACHIAVI - KEY HOLDER CHAINS

art. 91

40 cm - 15.74"

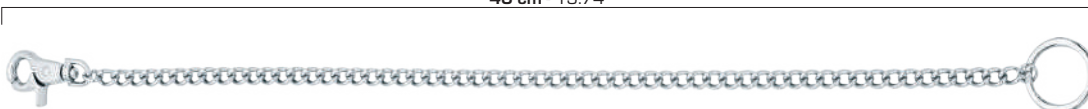



 **Acciaio nichelato**
Nickel plated steel

CATENELLE PORTACHIAVI - KEY HOLDER CHAINS

art. 92

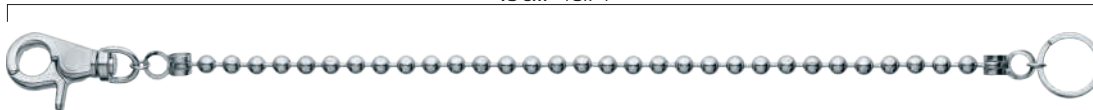
40 cm - 15.74"



 **Acciaio nichelato**
Nickel plated steel

CATENELLE PORTACHIAVI - KEY HOLDER CHAINS

art. 93

40 cm - 15.74"



 **Acciaio nichelato**
Nickel plated steel

CATENELLE PORTACHIAVI - KEY HOLDER CHAINS

art. 94

40 cm - 15.74"

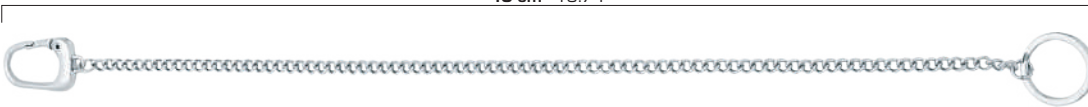

 **Acciaio nichelato**
Nickel plated steel

CATENELLE PORTACHIAVI - KEY HOLDER CHAINS

art. 96

40 cm - 15.74"

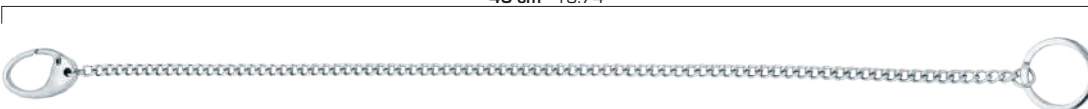

 **Acciaio nichelato**
Nickel plated steel

CATENELLE PORTACHIAVI - KEY HOLDER CHAINS

art. 97

40 cm - 15.74"

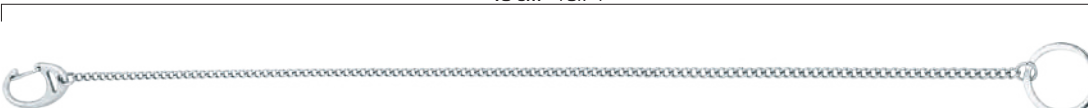

 **Acciaio nichelato**
Nickel plated steel

CATENELLE PORTACHIAVI - KEY HOLDER CHAINS

art. 98

40 cm - 15.74"

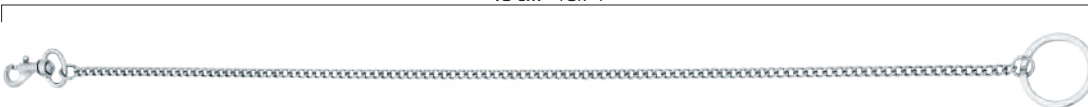

 **Acciaio nichelato**
Nickel plated steel

CATENELLE PORTACHIAVI - KEY HOLDER CHAINS

art. 99

40 cm - 15.74"

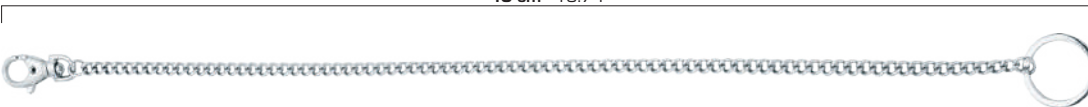

 **Acciaio nichelato**
Nickel plated steel



confezione da 12 pz.
12 pcs display



INDICE DEI CODICI - CODES INDEX

| art. | pag. | art. | pag. | art. | pag. | art. | pag. |
|------------|------|----------|------|----------------|------|--------------|------|
| FOX | | 408 G10 | 53 | 682N | 75 | FX-121 Ti | 36 |
| 35cm12 | 162 | 4400L | 46 | 683 | 77 | FX-130 DW | 37 |
| 35cm13 | 162 | 4450L | 70 | 686/36 | 75 | FX-130 MGT | 62 |
| 35cm14 | 162 | 456/2DOL | 42 | 689 | 73 | FX-131 DW | 63 |
| 36cm09 | 162 | 461G10 | 45 | 691/18 | 73 | FX-131 MGT | 62 |
| 37cm12 | 162 | 463DCB | 45 | 697T | 72 | FX-132 MGT | 62 |
| 38cm10 | 162 | 463DMOP | 45 | 698 | 72 | FX-133 MGT | 62 |
| 42cm13 | 162 | 468 | 67 | 699 | 72 | FX-140XL MB | 61 |
| 43cm14 | 162 | 474 ZW | 39 | 747 BSW | 80 | FX-143 MB | 61 |
| 47cm10 | 162 | 478 | 35 | 747 A | 80 | FX-230 MI BI | 19 |
| 48cm13 | 162 | 479 | 35 | 747 | 80 | FX-230 MI | 19 |
| 49cm14 | 162 | 479 TK | 36 | 747 D | 80 | FX-230 MI G | 19 |
| 91 | 163 | 500 B | 41 | 749 | 80 | FX-230 OL | 19 |
| 92 | 163 | 500D | 42 | 749 SX | 81 | FX-230 ZW | 19 |
| 93 | 163 | 500D/1 | 42 | 749 F | 81 | FX-273 | 17 |
| 94 | 163 | 500 G | 71 | 749 BSW | 81 | FX-273 CF | 17 |
| 96 | 163 | 500 O | 41 | 749 BSWF | 81 | FX-273 M I | 17 |
| 97 | 163 | 521 | 46 | 749/1 | 81 | FX-273 ZW | 17 |
| 98 | 163 | 551 | 49 | 748 | 82 | FX-302 | 24 |
| 99 | 163 | 573 CF | 18 | 1494RT | 44 | FX-302 ST | 24 |
| 201 | 56 | 575PW | 40 | 1499 | 46 | FX-303 OR | 74 |
| 202 | 57 | 576ML | 40 | 1500 OL | 46 | FX-304 | 74 |
| 221/1 | 47 | 576PW | 40 | 1502 OL | 65 | FX-305 | 37 |
| 233 | 41 | 576RT | 40 | 1503 OL | 65 | FX-305 G | 37 |
| 250/20CR | 54 | 577RT | 40 | 1504 OL | 65 | FX-306 | 22 |
| 250/20PO | 55 | 577ML | 41 | 1505 OL | 65 | FX-306 OL | 22 |
| 250/23CR | 54 | 580 | 48 | 1506 OL | 64 | FX-308 CF | 22 |
| 250/23PO | 55 | 581 | 48 | 1507 OL | 65 | FX-308 CFB | 22 |
| 250/28CR | 54 | 582 | 48 | 1684T | 73 | FX-308 ZW | 22 |
| 250/28PO | 55 | 582PW | 49 | 1685T | 73 | FX-503 FA | 55 |
| 250/33CR | 54 | 583 | 48 | 1699 BLACK | 72 | FX-510 | 66 |
| 250/33PO | 55 | 589 | 48 | 1699 CHAMPAGNE | 72 | FX-510 OD | 66 |
| 250/38CR | 54 | 590 | 47 | 2000 | 72 | FX-510 W | 66 |
| 251 | 56 | 594 | 44 | 2499DA | 42 | FX-514 | 21 |
| 256 | 56 | 596 CE | 69 | 2499DB | 42 | FX-515 | 39 |
| 257 | 56 | 596PW | 69 | 2607 CE | 70 | FX-515 W | 39 |
| 270 OL | 43 | 601 | 71 | 2608 | 70 | FX-518 | 26 |
| 271 DOL | 43 | 604 | 68 | 2610PW | 46 | FX-518 GR | 26 |
| 271 OL | 43 | 610/11 | 68 | BR-011F | 45 | FX-518 O | 26 |
| 273 DOL | 43 | 610/13 | 68 | BR-011W | 45 | FX-518 ZW | 26 |
| 273 OL | 43 | 612 | 71 | CL-627/1 | 53 | FX-519 | 27 |
| 279 CE | 44 | 614 | 71 | EXPO 3 | 155 | FX-519 GR | 27 |
| 279 OL | 44 | 619PW | 71 | EXPO 5 | 155 | FX-519 O | 27 |
| 290/2 | 47 | 620/13 | 68 | EXPO 6 | 155 | FX-519 ZW | 27 |
| 292/1 | 47 | 621/13 | 13 | EXPO 7 | 156 | FX-520 CB | 26 |
| 292/2 | 47 | 630 | 75 | EXPO 8 | 156 | FX-523 B | 23 |
| 294 | 56 | 632 | 67 | EXPO 9 | 156 | FX-523 OD | 23 |
| 300/18 B | 50 | 638 CE | 70 | EXPO 10 | 156 | FX-523 OR | 23 |
| 301/16 B | 50 | 639 CE | 70 | EXPO 11 | 155 | FX-524 TI | 9 |
| 301/18 B | 50 | 641 | 74 | EXPO 12 | 155 | FX-524 TiCF | 9 |
| 316 | 49 | 643/11 | 74 | EXPO 13 | 155 | FX-524 TiZW | 9 |
| 356/16 B | 51 | 646/11 | 74 | EXPO 14 | 155 | FX-524 B | 9 |
| 356/20 | 51 | 647 | 69 | FODF1 | 161 | FX-524 G | 9 |
| 369/13 B | 50 | 648 | 69 | FODF3 | 161 | FX-525 B | 38 |
| 369/15 B | 51 | 658 | 76 | FODF3 CUOIO N | 161 | FX-525 BE | 38 |
| 369/17 B | 51 | 660 | 76 | FODF3 NEUTRO | 161 | FX-525 DB | 38 |
| 369/19 B | 51 | 665/13 | 71 | FODF4 | 161 | FX-525 OL | 38 |
| 403 | 52 | 676 | 53 | FODF6 CUOIO | 161 | FX-525 Ti BL | 38 |
| 404 | 52 | 677F | 53 | FX-103 MB | 61 | FX-526 ALB | 11 |
| 405 | 52 | 680 | 77 | FX-120 TC | 27 | FX-526 ALG | 11 |
| 405 OL | 52 | 680 T | 77 | FX-121 CB | 36 | FX-526 ALO | 11 |
| 406 | 52 | 682 | 75 | FX-121 G10 | 36 | FX-526 CF | 10 |
| 408 | 53 | 682M | 75 | FX-121 MC | 36 | FX-526 CFBL | 10 |

| art. | pag. | art. | pag. | art. | pag. | art. | pag. |
|--------------|------|--------------|------|-----------------|------|----------------|------|
| FX-526LE CF | 10 | FX-599TiC | 28 | SK-02 BSW | 21 | FX-512 | 100 |
| FX-526LE COP | 10 | FX-599TiCS | 28 | SK-02 PVD | 21 | FX-512 OD | 100 |
| FX-526LE BR | 10 | FX-599 TK | 28 | TEK-LOK | 161 | FX-532 | 88 |
| FX-526 TCB | 11 | FX-599 XT | 29 | CLIP FX-211/213 | 161 | FX-595 | 98 |
| FX-526 TCBL | 11 | FX-599 XTTK | 29 | | | FX-595 W | 98 |
| FX-527 TIPVD | 12 | FX-599 XTS | 29 | FKMD | | FX-601 | 103 |
| FX-527 TI | 12 | FX-600 W | 69 | 637 OL | 106 | FX-636T | 106 |
| FX-527 CF | 12 | FX-604 | 14 | 640 | 154 | FX-637T | 106 |
| FX-528 | 23 | FX-604 B | 14 | 640 OD | 154 | FX-640/22EY | 154 |
| FX-528 B | 23 | FX-604 BL | 15 | 640/1 | 154 | FX-640/22OD | 155 |
| FX-531 TI B | 24 | FX-604 OD | 14 | 641/11FNK | 111 | FX-640/22RD | 154 |
| FX-531 TI BL | 24 | FX-604 OR | 14 | AMK-279 | 104 | FX-805 B | 99 |
| FX-531 TI BR | 24 | FX-604 R | 14 | CED-01 S | 95 | FX-810 B | 99 |
| FX-533 CF | 20 | FX-605 | 63 | FKU-HV02TIB | 94 | FX-811 B | 99 |
| FX-533 TI | 20 | FX-605 OD | 63 | FKU-HV02TTIB | 94 | FX-813 B | 99 |
| FX-534 | 25 | FX-606 | 64 | FX-0107153 | 100 | FX-1661TK | 104 |
| FX-534 B | 25 | FX-606 OD | 64 | FX-0107153/1SK | 158 | FX-1663TK | 104 |
| FX-534 CF | 25 | FX-607 | 64 | FX-0110 M | 95 | FX-1665TK | 104 |
| FX-534 O | 25 | FX-607 OR | 64 | FX-0110 W | 95 | FX-1666TK | 104 |
| FX-535 | 34 | FX-608 TI | 12 | FX-0171100 | 105 | FX-1682 | 105 |
| FX-535 B | 34 | FX-608 CF | 12 | FX-0171101 B | 107 | FX-1694 | 105 |
| FX-535 BL | 34 | FX-608 MC | 13 | FX-0171101 CT | 107 | FX-3002 | 109 |
| FX-535 BLB | 35 | FX-608 BL | 13 | FX-0171102 | 107 | FX-3003 | 109 |
| FX-535 O | 34 | FX-608 OR | 13 | FX-0171106 | 108 | FX-3004 | 111 |
| FX-535 OB | 35 | FX-608 R | 13 | FX-0171107 | 108 | FX-9CM01B | 101 |
| FX-535 R | 34 | FX-608 B | 13 | FX-0171109 | 103 | FX-9CM02B | 102 |
| FX-535 RB | 35 | FX-609 OD | 62 | FX-0171111 | 153 | FX-9CM04BT | 101 |
| FX-536 | 32 | FX-610 | 62 | FX-0171111/1 | 153 | FX-9CM04T | 101 |
| FX-536 B | 33 | FX-620 B | 63 | FX-0171112 | 103 | FX-9CM05BT | 101 |
| FX-536 CB | 32 | FX-621 B | 63 | FX-0171113 | 112 | FX-9CM05T | 101 |
| FX-536 CBB | 33 | FX-622 B | 20 | FX-0171114 | 107 | FX-9CM06 | 100 |
| FX-536 G | 32 | FX-630 B | 61 | FX-0171115 | 107 | FX-9CM07 | 98 |
| FX-536 GB | 33 | FX-633 | 60 | FX-0171116 | 109 | FX-9CM07 OD | 98 |
| FX-536 OD | 32 | FX-633 MOD | 60 | FX-0171117 | 109 | FX-ALSR 49 | 92 |
| FX-536 ODB | 33 | FX-634 | 60 | FX-0193000 | 108 | FX-ATC01 | 102 |
| FX-536 P | 32 | FX-634 MOD | 60 | FX-0193001 | 108 | FX-ATC02 | 102 |
| FX-536 PB | 33 | FX-634 DCF | 60 | FX-117 CT | 90 | FX-AVES12 | 99 |
| FX-537 BR | 20 | FX-679 | 77 | FX-117 T | 90 | FX-CED-M2C | 102 |
| FX-537 SW | 20 | FX-693 | 76 | FX-211 | 93 | FX-G2B | 110 |
| FX-540 TIBL | 15 | FX-694 | 76 | FX-212 | 93 | FX-G2DC | 110 |
| FX-540 TIB | 15 | FX-695 | 76 | FX-213SS | 93 | FX-G3B | 110 |
| FX-540 G100D | 15 | FX-800 MK | 31 | FX-213TS | 93 | FX-G4B | 106 |
| FX-540 NA | 15 | FX-801 MK | 67 | FX-214 | 93 | FX-G4BS | 106 |
| FX-550 DCFR | 16 | FX-1688TS | 64 | FX-310 | 95 | FX-MATB | 155 |
| FX-550 CFB | 16 | FX-BR322 | 44 | FX-401 OR | 95 | FX-MATGR | 155 |
| FX-550 TiB | 16 | FX-CAP01B | 162 | FX-446 B | 88 | FX-MIR112 | 94 |
| FX-550 Ti | 16 | FX-CAP01GR | 162 | FX-446 BS | 89 | FX-MIR115/2VVF | 102 |
| FX-550 G10B | 16 | FX-CAP01GY | 102 | FX-446 GR | 89 | FX-MP01 TI KIT | 152 |
| FX-550 G100D | 17 | FX-F2017 | 39 | FX-446 GRS | 89 | FX-MTF5 | 90 |
| FX-582 | 18 | FX-F2017 D | 39 | FX-446 OD | 89 | FX-NR01 TT | 103 |
| FX-582 CF | 18 | FX-RL01 G10 | 37 | FX-446 ODS | 89 | FX-NR03 CT | 103 |
| FX-582 MI | 18 | FX-RCSTF-01 | 94 | FX-447 C | 92 | FX-P1DC | 110 |
| FX-582 OL | 18 | FX-RCSTF-02 | 94 | FX-447 CB | 92 | FX-P3B | 110 |
| FX-590 | 29 | FX-ZF01 | 161 | FX-447 COD | 92 | FX-SCT01B | 108 |
| FX-591 | 31 | HH-10 | 157 | FX-447 SFB | 92 | FX-SCT02B | 108 |
| FX-591 OD | 31 | HH-11 | 157 | FX-448 B | 88 | MTD B | 151 |
| FX-591 ODSW | 31 | HH-12 | 157 | FX-448 OD | 88 | MTD BL | 155 |
| FX-591 TK | 31 | HH-13 | 157 | FX-448 T | 88 | MTD G | 155 |
| FX-592 | 66 | OLC-0112/2TI | 25 | FX-500 | 91 | MTD O | 155 |
| FX-592 W | 66 | PL001 | 157 | FX-501 | 91 | MTD OD | 155 |
| FX-593 | 67 | PL002 | 157 | FX-504 B | 90 | MTD R | 155 |
| FX-597 | 30 | PL004 | 157 | FX-505 | 91 | MTD/2 BL | 152 |
| FX-597 TK | 30 | PL005 | 157 | FX-505GR | 91 | MTD/2 G | 152 |
| FX-598 | 67 | PL006 | 157 | FX-506GR | 91 | MTD/2 OD | 152 |
| FX-599 | 28 | PL007 | 157 | FX-507 | 105 | OMG-1 | 112 |
| FX-599 RS | 28 | SK-02 BR | 21 | FX-508 | 105 | S 8126B | 155 |
| FX-599 RSY | 29 | SK-02 OD | 21 | FX-509 CT | 100 | S 8126N | 155 |

| art. | pag. | art. | pag. | art. | pag. | art. | pag. |
|-----------------|------|------------|------|------------|------|-----------------------------------|------|
| SF-CC03 | 111 | BF-205 | 141 | BF-729 | 124 | BF-751 O | 119 |
| SF-DB03 | 111 | BF-205 OR | 141 | BF-729 SW | 124 | BF-751 BL | 119 |
| SF-F2000 | 111 | BF-205 R | 141 | BF-730 | 126 | BF-752 | 120 |
| SF-F2000 FN | 111 | BF-237 | 128 | BF-732 | 126 | BF-752 OD | 120 |
| SLO-01S | 90 | BF-300 | 158 | BF-732 G | 126 | BF-CL16P | 138 |
| BLACKFOX | | BF-301 | 159 | BF-734 | 136 | BF-CL18P | 138 |
| BF-001SD | 135 | BF-434G10 | 127 | BF-735 | 137 | BF-CL22P | 138 |
| BF-004WD | 135 | BF-434ZW | 127 | BF-736 | 122 | EX-001620-BLK | 158 |
| BF-006WD | 135 | BF-500 | 124 | BF-736TI | 122 | TS 807 | 144 |
| BF-007WD | 135 | BF-501 | 124 | BF-737 | 122 | TS 815 | 144 |
| BF-010WD | 134 | BF-501TK | 124 | BF-738TI | 122 | TS 816 | 144 |
| BF-69 | 128 | BF-700T | 138 | BF-739 | 123 | TS 819 | 144 |
| BF-73 | 128 | BF-704 | 126 | BF-739TI | 123 | TS 820 | 144 |
| BF-74 | 128 | BF-705T | 126 | BF-740 | 120 | TS 825 | 144 |
| BF-79 | 127 | BF-710 | 135 | BF-740 OD | 120 | TS 828 | 144 |
| BF-80 | 129 | BF-711 | 135 | BF-740TI | 120 | | |
| BF-81 | 129 | BF-712 | 136 | BF-741 | 134 | ALTRI BRAND - OTHER BRANDS | |
| BF-90 | 128 | BF-713 | 136 | BF-743 | 122 | 2C 203/16 B | 49 |
| BF-91 | 126 | BF-714OR | 120 | BF-744 | 123 | 2C 204/19 B | 49 |
| BF-920 | 128 | BF-716 | 127 | BF-744 ZW | 123 | 2C 205/20 B | 50 |
| BF-105 | 129 | BF-717 | 127 | BF-745 | 123 | 2C 730/7 | 158 |
| BF-105T | 129 | BF-719 | 121 | BF-746 | 125 | K-80001 | 156 |
| BF-111T | 130 | BF-719 G10 | 121 | BF-746 OD | 125 | K-80002 | 156 |
| BF-110TS | 130 | BF-719 MI | 121 | BF-747 | 125 | SOG 182/B66 | 150 |
| BF-115 | 130 | BF-719 MIN | 121 | BF-748 CR | 118 | SOG 182/B66 EOD | 150 |
| BF-114 | 130 | BF-719 ZW | 121 | BF-748 MI | 118 | SOG ID1001CP | 148 |
| BF-117 | 130 | BF-720 | 137 | BF-748 MIB | 118 | SOG ID1011CP | 148 |
| BF-132 | 134 | BF-721 | 125 | BF-748 ZW | 118 | SOG ID1021CP | 149 |
| BF-200 | 143 | BF-721G | 125 | BF-749 | 134 | SOG ID1031CP | 149 |
| BF-201 | 143 | BF-722 | 137 | BF-750 | 118 | SOG PA1001-CP | 146 |
| BF-203 | 142 | BF-724 | 137 | BF-750 OD | 119 | SOG PA 2001-CP | 146 |
| BF-204 | 142 | BF-726 | 137 | BF-750 BL | 119 | SOG PL1001-CP | 147 |
| | | BF-728 | 136 | BF-751 | 119 | SOG PP1001-CP | 147 |

LEGENDA - LEGEND

Utilizzare questo schema per leggere le informazioni riportate presso i singoli articoli. In questa legenda, accanto ad ogni icona, è indicato ciò che essa rappresenta (per esempio "materiale del manico"), mentre, presso l'articolo da catalogo, è specificata l'entità di quella caratteristica (per esempio "Titanio anodizzato blu"). Ne consegue che, presso l'articolo da catalogo, accanto all'icona del manico si troverà scritto il materiale di cui è fatto.

Use this pattern to read the information found in the individual articles. In this legend, next to every icon, you can find the description of what it means, in order to understand what the information on the catalog item refers to.

NOME - NAME by Designer - CHIUSURA/CLOSURE

CODICE/ CODE

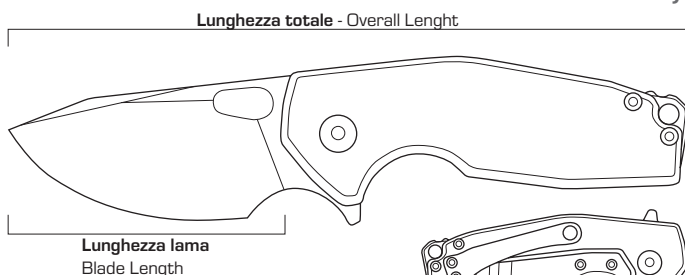

| | | | |
|--|--|--|--|
| | Acciaio della lama Blade Steel | | Materiale del Liner/Frame lock Liner/Frame lock material |
| | HRC Durezza scala Rockwell Rockwell scale hardness | | Materiale della clip Clip material |
| | Trattamento superficiale della lama Blade finish | | Materiale del distanziale Spacer material |
| | Spessore della lama Blade thickness | | Materiale degli standoff Standoffs material |
| | Peso dell'articolo Weight | | Materiale delle viti Screws material |
| | Materiale del manico Handle material | | Materiale delle bocche Rivets material |
| | Materiale del pulsante (Radius) Button material (Radius) | | Materiale del fodero Sheath material |
| | Materiale della leva (Slipjoint) Spring bar material (Slipjoint) | | Materiale dell'anello Karambit Karambit ring material |
| | Materiale della leva (Back lock) Spring bar material (Back lock) | | Materiale del perno di apertura Thumb stud material |
| | Materiale del frangivetro Glass breaker material | | Materiale dei rivetti Rivets material |
| | Materiale dello spuntone Spike material | | |

FINITURE - FINISHES

Satinatura - Satin finish

Levigatura operata sulla lama in un'unica direzione con abrasivi di grado via via crescente. Questa operazione risalta le linee della lama e riduce il riverbero riflettente.

Sanding performed on the blade in a single direction with gradually increasing grade of abrasives. This brings out the lines of the blade and reduces reflective glare.



Sabbiatura - Bead blasting

Abrasione superficiale dell'acciaio mediante un forte getto di sabbia o sfere di vetro che ne rende opaca la finitura.

Surface abrasion of the steel obtained with a strong jet of sand or glass beads which gives it an opaque finish.



Stone wash

Trattamento che produce lievi scalfitture superficiali sull'acciaio mediante impatto con pietra o ceramica. Si ottiene un effetto "invecchiato" che non compromette le qualità della lama. Questa lavorazione può essere applicata su superfici già finite con trattamenti diversi come, per esempio, l'idroglider o il PVD.

Treatment that produces slight surface scratches on steel by impact with stone or ceramic. An "Aged" effect is obtained which does not compromise the qualities of the blade. This process can be applied on surfaces that are already finished with different treatments such as, for example, idroglider or PVD.



Coarse stone wash

Finitura che comprende due passaggi: una prima sabbiatura effettuata con getti di corindone con cui si ottiene una finitura opaca, più scura e grezza rispetto alla normale sabbiatura. Viene poi applicato lo Stone wash.

Finish that includes two steps: a first sandblasting carried out with corundum jets with which a matte finish is obtained, darker and coarser than normal sandblasting. The Stone wash is then applied.



idroglider

Speciale rivestimento superficiale a base di PTFE molto resistente ad abrasioni e all'acqua. È possibile applicarlo in vari colori

Special non stick coating made of PTFE that ensures long life and rust resistance. It's possible to apply it in several colors.



Cerakote™

È un rivestimento superficiale a base nano-ceramica applicato sui metalli, migliora la resistenza all'usura, all'abrasione, alla corrosione, all'urto e agli agenti chimici.

It is a ceramic based finish that can be applied to metals, enhance a number of physical performance properties including abrasion/wear resistance, corrosion resistance, chemical resistance, impact strength and hardness.



Top Shield®

Rivestimento a base di vernice ceramica che garantisce alta protezione da graffi e agenti aggressivi, offre resistenza da delaminazione fino a 450°C. Ideale per proteggere attrezzatura militare ed armi da fuoco.

Coating based on ceramic paint that guarantees high protection against scratches or aggressive agents and grants delamination resistance up to 450°C. Ideal for protecting military equipment and firearms.



PVD

Trattamento di apporto superficiale attraverso la deposizione fisica da vapore (Physical Vapor Deposition) è un metodo comune per la deposizione di film sottili sottovuoto che consente il miglioramento delle caratteristiche di utensili da taglio.

[Physical Vapor Deposition] is a variety of vacuum deposition methods used to deposit thin films by the condensation of a vaporized form of the desired film material onto various workpiece surface. The coating method involves purely physical process such as high temperature vacuum evaporation with subsequent condensation.



MIL SPEC

La brunitura dell'acciaio inox si ottiene per immersione in Sali alcalini ossidanti alla temperatura di 120/130°C. Lo spessore dello strato di brunitura, costituito essenzialmente da ossidi, ha valore intorno a 0,1 micron e quindi non influenza le dimensioni dei particolari trattati.

Conforme alla specifica MIL-DTL-13924

The burnishing of stainless steel is obtained by immersion in oxidizing alkaline salts at a temperature of 120/130 °C. The thickness of the burnishing layer, essentially consisting of oxides, has a value of around 0.1 micron and therefore does not affect the dimensions of the treated parts.

Complies with MIL-DTL-13924 specification



Anodizzazione - Anodizing

Processo utilizzato su alluminio e titanio che produce uno strato di ossido (5-20 µm) il quale protegge il metallo dalla corrosione e può conferire varie colorazioni.

Process used on Aluminum and Titanium that produces an oxide layer (5-20 µm) which protects the metal from corrosion and can give several colors.



Bagno in acido cloridrico Etching with hydrochloric acid

È un trattamento applicato sulle lame in damasco atto a far emergere il contrasto chiaro-scuro tra gli strati dei diversi acciai.

It is a treatment made on the damascus blades applied to bring out the light-dark contrast between the layers of different steels.



TABELLA DEGLI ACCIAI - STEEL CHART

| | C | Cr | Co | N | Mn | Mo | Ni | P | Si | S | W | V | Nb |
|--------------------------|----------------------------|---------------------------|---------------------------|---------------------------|--------------------------------|---------------------------------|--------------------------|--------------------------------|----------------------------|-------------------------|----------------------------|-----------------------------|---------------------------|
| Acciaio Steel | Carbonio Carbon | Cromo Chromium | Cobalto Cobalt | Azoto Nitrogen | Manganese Manganese | Molibdeno Molybdenum | Nichel Nickel | Fosforo Phosphorous | Silicio Silicon | Zolfo Sulfur | Tungsteno Tungs | Vanadio Vanadium | Niobio Niobium |
| 1.4116 | 0.45-0.55 | 14.00-15.00 | - | - | 1.00 | 0.50-0.80 | - | 0.04 | 0.75 | 0.015 | - | - | - |
| SANDVIK 12C27 | 0.60 | 13.50 | - | - | 0.50 | - | - | 0.03 | 0.40 | 0.02 | - | - | - |
| 420J2B | 0.38 | 13.60 | - | - | 0.50 | - | - | - | 0.75 | 0.03 | - | 0.30 | - |
| 440 A | 0.70 | 16.00 | - | - | 1.00 | 0.75 | - | 0.04 | 1.00 | 0.03 | - | - | - |
| 440 B | 0.90 | 16.00 | - | - | 1.00 | 0.75 | - | 0.04 | 1.00 | 0.03 | - | - | - |
| 440 C | 1.00 | 17.50 | - | - | 0.50 | 0.50 | - | 0.04 | 0.30 | 0.03 | - | - | - |
| 4119 nitro-B | 0.51 | 14.60 | - | 0.16 | 0.50 | 0.60 | - | 0.03 | 0.60 | 0.01 | - | 0.11 | - |
| C70 | 0.70 | - | - | - | 0.80 | - | - | 0.4 | 0.30 | 0.035 | - | - | - |
| VG10 | 1.00 | 15.00 | 1.50 | - | - | 1.00 | - | - | - | - | - | 0.20 | - |
| Elmax | 1.70 | 18.00 | - | - | 0.30 | 1.00 | - | - | 0.80 | - | - | 3.00 | - |
| N690CO | 1.08 | 17.30 | 1.50 | - | 0.40 | 1.10 | - | - | 0.40 | - | - | 0.10 | - |
| M390 | 1.90 | 20.00 | - | - | 0.30 | 1.00 | - | - | 0.70 | - | 0.50 | 4.00 | - |
| D2 | 1.550 | 11.58 | - | - | 0.36 | 0.73 | - | 0.023 | 0.26 | 0.0011 | - | 0.73 | - |
| NILOX | 0.80 | 12.70 | - | - | - | 1.10 | - | - | - | - | - | 0.90 | 0.70 |
| CPM S90V | 2.30 | 14.00 | - | - | - | 1.00 | - | - | - | - | - | 9.00 | - |
| SPM 20CV | 1.90 | 20.00 | - | - | 0.30 | 1.00 | - | - | 0.30 | - | 0.60 | 4.00 | - |
| BECUT | 0.72 | 14.50 | - | - | 0.45 | 1.90 | - | - | 0.45 | - | - | 0.60 | 0.80 |
| RWL34* | 1.05 | 14 | - | - | 0.50 | 4 | - | - | 0.50 | - | - | 0.20 | - |
| PMC27* | 0.60 | 13 | - | - | 0.50 | - | - | - | 0.50 | - | - | - | - |
| N11X* | 0.36 | 18.2 | - | - | 0.3 | 1.10 | - | - | 0.3 | - | - | 3,5 | 1.55 |

Tutti i prodotti di questo catalogo non si intendono realizzati per essere utilizzati con gli alimenti, di conseguenza sono esenti dai provvedimenti disciplinati dal Regolamento CE 1935/2004, 2023/06, e D-Lgs. 29/17 e succ. mod.

All products in this catalog are not intended to be used with food, consequently they are exempt from the provisions governed by EC Regulation 1935/2004, 2023/06, and D-Lgs. 29/17 and succ. mod

© 2021 Oreste Frati srl

Le coltellerie FOX si riservano il diritto di modificare quanto indicato nel presente catalogo senza preavviso. FOX cutlery reserves the right to modify what indicated in this catalogue without notice.